

ALM2

COME ORDINARE / HOW TO ORDER

ALM2	TIPO TYPE	ROTAZIONE ROTATION	TAGLIA SIZE	ALBERO* SHAFT*	PORTE* PORTS*	GUARNIZIONI* SEALS*	OPZIONI* OPTIONS*	DRENAGGIO** DRAIN**
	omit	D DESTRA CLOCKWISE	6					
	A	S SINISTRA COUNTER CLOCKWISE	9					
	BK1	R REVERSIBILE REVERSIBLE	10					
	BK2		12					
	BK4		13					
	BK7		16					
			20					
			22					
			25					
			30					
			34					
			37					
			40					
			...					

Guarnizioni / Seals
omit (T range = -10°C + 80°C)
V
...

Opzioni / Options
OR****
...

Drenaggio / Drain
E0 = drenaggio interno/internal drain
E1 = drenaggio esterno/external drain G1/4
***E2 = drenaggio esterno/external drain 9/16-18 UNF
***E4 = drenaggio esterno/external drain 7/16-20 UNF (solo per porte KA/only for KA ports)
...

(*) = campi da specificare se diversi dallo standard "tipo motore" / to be specified if different from standard "motor type"
(**) = solo per rotazione R / only for R rotation
(***) = le porte di drenaggio sono lavorate secondo la specifica SAE J1926/1 (ISO 11926-1) relativa a porte filettate con tenuta O-ring. Profondità utile 12,7 mm. / Drain port are machined in compliance with threaded port with O-ring seal in truncated housing SAE J1926/1 (ISO 11926-1). Thread depth 12,7 mm.
(****) = solo per tipi motore A e BK1 / only for A and BK1 motor types

Tipi Motore Standard / Motor Standard Types

omit	= flangia europea + albero T0 + porte E + guarnizioni standard / european flange + shaft T0 + ports E + standard seals
A	= flangia A + albero C1 + porte FA + guarnizioni standard / flange A + shaft C1 + ports FA + standard seals
BK1	= flangia BK1 + albero T1 + porte D + guarnizioni standard / flange BK1 + shaft T1 + ports D + standard seals
BK2	= flangia BK2 + albero T2 + porte D + guarnizioni standard / flange BK2 + shaft T2 + ports D + standard seals
BK4	= flangia BK4 + albero T2 + porte D + guarnizioni standard / flange BK4 + shaft T2 + ports D + standard seals
BK7	= flangia BK7 + albero G0 + porte D + guarnizioni standard / flange BK7 + shaft G0 + ports D + standard seals

Esempi / Examples:

ALM2-D-6	= motore destro, 4,5 cc/rev, flangia europea, albero conico 1:8, porte flangiate tipo E, guarnizioni standard clockwise rotation, 4,5 cc/rev, european flange, 1:8 tapered shaft, flanged ports E type, standard seals
ALM2-D-6-C0	= motore destro, 4,5 cc/rev, flangia europea, albero cilindrico (C0), porte flangiate tipo E, guarnizioni standard clockwise rotation, 4,5 cc/rev, european flange, cylindrical shaft (C0), flanged ports E type, standard seals
ALM2BK2-D-6-E	= motore destro, 4,5 cc/rev, flangia tedesca quadrata, albero conico 1:5, porte flangiate tipo (E), guarnizioni standard clockwise rotation, 4,5 cc/rev, german square flange, 1:5 tapered shaft, european flanged ports (E), standard seals
ALM2BK2-R-13-E1	= motore reversibile, 9,6 cc/rev, flangia tedesca quadrata, albero conico 1:5, porte flangiate tipo D, guarnizioni standard, drenaggio esterno (E1) reversible motor, 9,6 cc/rev, german square flange, 1:5 tapered shaft, flanged ports D type, standard seals, external drain (E1)
ALM2A-R-6-OR	= motore reversibile, 4,5 cc/rev, flangia SAE a 2 fori, albero cilindrico C1, porte filettate FA, guarnizioni standard, guarnizione OR sul colletto Reversible motor, 4,5 cc/rev, SAE A 2 bolt flange, cylindrical shaft C1, threaded ports FA, standard seal, OR seal on pilot

LE TAVOLE DI PRODOTTO RAPPRESENTANO I TIPI MOTORE STANDARD PER MARZOCCHI POMPE. LE TAVOLE SINOTTICHE DI FLANGE, ALBERI E PORTE HANNO LO SCOPO DI RAPPRESENTARE TUTTE LE POSSIBILI CONFIGURAZIONI DI PRODOTTO. PER MAGGIORI DETTAGLI SULLE DISPONIBILITÀ E CONDIZIONI DI FORNITURA, CONSIGLIAMO DI INTERPELLARE IL NOSTRO UFFICIO TECNICO-COMMERCIALE.

THE PRODUCT DATA SHEETS SHOW OUR STANDARD MODEL TYPES. THE SYNOPTIC TABLES FOR FLANGES, SHAFTS AND PORTS SHOW ALL THE POSSIBLE CONFIGURATIONS. FOR FURTHER DETAILS ABOUT THE AVAILABILITY OF EACH CONFIGURATION PLEASE CONTACT OUR SALES AND TECHNICAL DEPT.

Part number:

076-10858b**HYDROMA**

HYDRAULICKÉ SYSTÉMY

**HIDROMA
SYSTEMS**

UKŁADY HYDRAULICZNE

HYDROMA

ГИДРАВЛИЧЕСКИЕ СИСТЕМЫ

ALM2

Parti accessorie a corredo della pompa standard: linguetta a disco (codice 522057), dado M12x1.5 (codice 523016), rosetta elastica spaccata (codice 523005).
Porte standard: filetti M8 profondità utile 17 mm.
Drenaggio G1/4 profondità utile 12 mm.
Disponibile su richiesta albero conico con linguetta a disco di spessore 3,2 mm ("T3").

Accessories supplied with the standard pump: woodruff key (code 522057), M12x1.5 exagonal nut (code 523016), washer (code 523005).
Standard ports: M8 threads depth 17 mm.
G1/4 drain port thread depth 12 mm.
The tapered shaft is also available with 3,2 mm key ("T3").

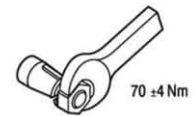
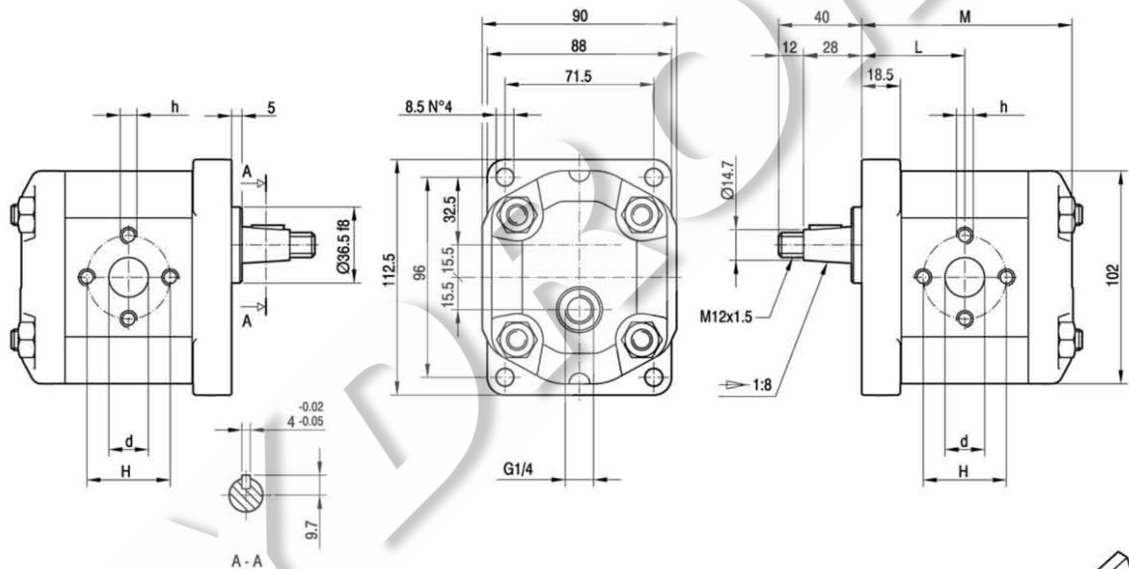

TIPO TYPE	CILINDRATA DISPLACEMENT	PORTATA a 1500 giri/min FLOW at 1500 rev/min	PRESSIONI MASSIME MAX PRESSURE			VELOCITÀ MASSIMA MAX SPEED	DIMENSIONI DIMENSIONS				
			P ₁	P ₂	P ₃		L	M	d	h	H
	cm ³ /giro [cm ³ /rev]	litri/min [litres/min]	bar	bar	bar	giri/min [rpm]	mm	mm	mm	mm	mm
ALM2-R-6-E1	4,5	6,4	250	240	270	4000	45,5	93,5	13	M6	30
ALM2-R-9-E1	6,4	9,1	250	240	270	4000	47	96,5	13	M6	30
ALM2-R-10-E1	7	10	250	240	270	4000	47,5	97,5	13	M8	40
ALM2-R-12-E1	8,3	11,8	250	240	270	3500	48,5	99,5	13	M8	40
ALM2-R-13-E1	9,6	13,7	250	240	270	3000	49,5	101,5	13	M8	40
ALM2-R-16-E1	11,5	16,4	230	220	250	4000	51	104,5	19	M8	40
ALM2-R-20-E1	14,1	20,1	230	220	250	4000	53	108,5	19	M8	40
ALM2-R-22-E1	16,0	22,8	210	200	225	4000	54,5	111,5	19	M8	40
ALM2-R-25-E1	17,9	25,5	210	200	225	3600	56	114,5	19	M8	40
ALM2-R-30-E1	21,1	30,1	180	170	195	3200	58,5	119,5	19	M8	40
ALM2-R-34-E1	23,7	33,7	180	170	195	3000	60,5	123,5	19	M8	40
ALM2-R-37-E1	25,5	36,4	170	160	185	2800	62	126,5	19	M8	40
ALM2-R-40-E1	28,2	40,1	170	160	185	2500	64	130,5	19	M8	40

Part number:

076-10858c

HYDROMA

HYDRAULICKÉ SYSTÉMY

**HIDROMA
SISTEMS**

UKŁADY HYDRAULICZNE

HYDROMA

ГИДРАВЛИЧЕСКИЕ СИСТЕМЫ

ALM2

FLANGE / FLANGES

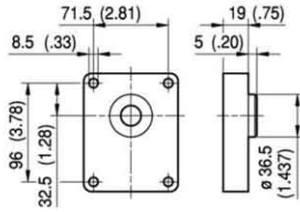

ALBERI / SHAFTS

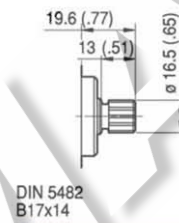
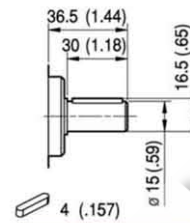
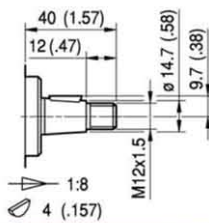

TO

Coppia Max
Max Torque 200 Nm

C0

Coppia Max
Max Torque 135 Nm

S0

DIN 5482
B17x14

Coppia Max
Max Torque 140 Nm

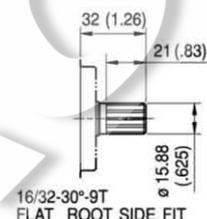
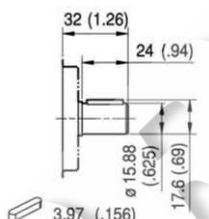
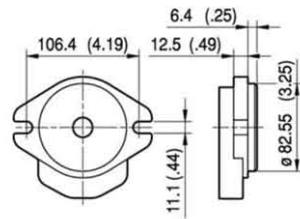

C1

Coppia Max
Max Torque 140 Nm

S1

Coppia Max
Max Torque 185 Nm

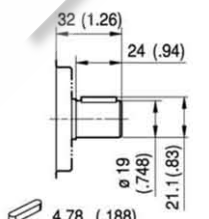

C2

Coppia Max
Max Torque 160 Nm

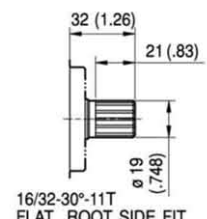

S2

Coppia Max
Max Torque 200 Nm

Part number:

076-10858d

HYDROMA

HYDRAULICKÉ SYSTÉMY

**HIDROMA
SYSTEMS**

UKŁADY HYDRAULICZNE

HYDROMA

ГИДРАВЛИЧЕСКИЕ СИСТЕМЫ

ALM2

PORTE / PORTS

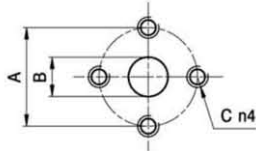

E

TIPO TYPE	MOTORE BIDIREZIONALE BI-DIRECTIONAL MOTOR			MOTORE MONODIREZIONALE MONO-DIRECTIONAL MOTOR		
	USCITA - ENTRATA OUTPUT - INPUT			ENTRATA INPUT		
	A	B	C	A	B	C
ALM2...6 ÷ ALM2...9	30	13	M6	30	13	M6
ALM2...10 ÷ ALM2...13	40	13	M8	40	13	M8
ALM2...16 ÷ ALM2...25	40	19	M8	40	13	M8
ALM2...30 ÷ ALM2...40	40	19	M8	40	19	M8

I valori delle coppie di serraggio delle viti presenti nel kit raccordo sono indicate a pag 46 (capitolo accessori).
Tightening torques of the fittings screws are specified on page 46 (accessories section).

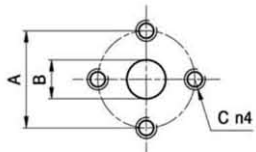

EP

TIPO TYPE	MOTORE BIDIREZIONALE BI-DIRECTIONAL MOTOR			MOTORE MONODIREZIONALE MONO-DIRECTIONAL MOTOR		
	USCITA - ENTRATA OUTPUT - INPUT			ENTRATA INPUT		
	A	B	C	A	B	C
ALM2...6 ÷ ALM2...13	30	13	M6	30	13	M6
ALM2...16 ÷ ALM2...40	40	19	M8	30	13	M6

I valori delle coppie di serraggio delle viti presenti nel kit raccordo sono indicate a pag 46 (capitolo accessori).
Tightening torques of the fittings screws are specified on page 46 (accessories section).

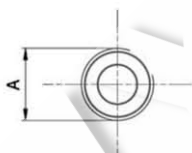

FG

TIPO TYPE	MOTORE BIDIREZIONALE BI-DIRECTIONAL MOTOR		MOTORE MONODIREZIONALE MONO-DIRECTIONAL MOTOR	
	USCITA - ENTRATA OUTPUT - INPUT		ENTRATA INPUT	
	A		A	
ALM2...6 ÷ ALM2...16	G1/2		G1/2	
ALM2...20 ÷ ALM2...40	G3/4		G1/2	

Raccordo G1/2 coppia di serraggio massima 50 Nm. Raccordo G3/4 coppia di serraggio massima 60 Nm.
Consigliamo di richiedere conferma al fornitore del raccordo.
Tightening torques for G1/2 fitting: 50 Nm. Tightening torques for G3/4 fitting: 60 Nm. Please check with the fittings suppliers.

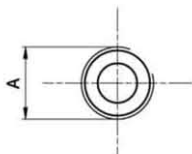

FC

TIPO TYPE	MOTORE BIDIREZIONALE BI-DIRECTIONAL MOTOR		MOTORE MONODIREZIONALE MONO-DIRECTIONAL MOTOR	
	USCITA - ENTRATA OUTPUT - INPUT		ENTRATA INPUT	
	A		A	
ALM2...6 ÷ ALM2...16	Rc1/2		Rc1/2	
ALM2...20 ÷ ALM2...40	Rc3/4		Rc1/2	

Raccordo Rc1/2 coppia di serraggio massima 50 Nm. Raccordo Rc3/4 coppia di serraggio massima 60 Nm.
Consigliamo di richiedere conferma al fornitore del raccordo.
Tightening torques for Rc1/2 fitting: 50 Nm. Tightening torques for Rc3/4 fitting: 60 Nm. Please check with the fittings suppliers.

Part number:

076-10858e

HYDROMA

HYDRAULICKÉ SYSTÉMY

**HIDROMA
SYSTEMS**

UKŁADY HYDRAULICZNE

HYDROMA

ГИДРАВЛИЧЕСКИЕ СИСТЕМЫ

Potenza erogata *Delivered power* P [kW]
Momento torcente erogato *Delivered torque* M [Nm]
Velocità di rotazione *Drive speed* n [giri/min] [rpm]

