

Part number:

060-10024

HYDROMA

HYDRAULICKÉ SYSTÉMY

**HIDROMA
SYSTEMS**

UKŁADY HYDRAULICZNE

HYDROMA

ГИДРАВЛИЧЕСКИЕ СИСТЕМЫ



I termostati serie TM4/A1-TM4/C1 permettono la chiusura o l'apertura di un contatto elettrico al raggiungimento di un valore fisso di temperatura. Il corpo del termostato consente una rotazione di 90° rispetto all'attacco di processo.

The thermo-switches TM4/A1-TM4/C1 series allow the closing or the opening of an electrical contact when the fluid temperature exceeds the set-point value of the thermo-switch. The special design of the body thermo-switch enables a 90° rotation compared to the main power supply connection.

**CARATTERISTICHE TECNICHE
TECHNICAL FEATURES**

Temperatura d'impiego : da -20°C a 120°C

Working temperature : from -20°C to 120°C

Frequenza di commutazione : 20 cicli/min

Commutation frequency : 20 cycles/min

Precisione d'intervento : +/-3,5°C

Switching accuracy : +/-3,5°C

Valore fisso d'isteresi: 12°C del valore impostato

Fixed hysteresis value : about 12°C

Corpo: ottone

Body material : brass

Attacco di processo: 1/2" BSP (guarnizione incorporata)

Thread connection : 1/2" BSP (seal included)

Pressione massima : 200 bar

Max pressure : 200 bar

Montaggio : in ogni posizione

Mounting : in any position

Peso : 70 gr.

Weigth : 70 gr

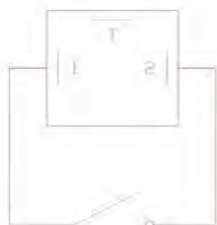
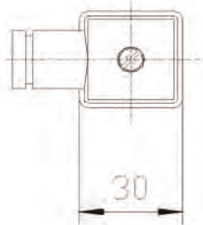
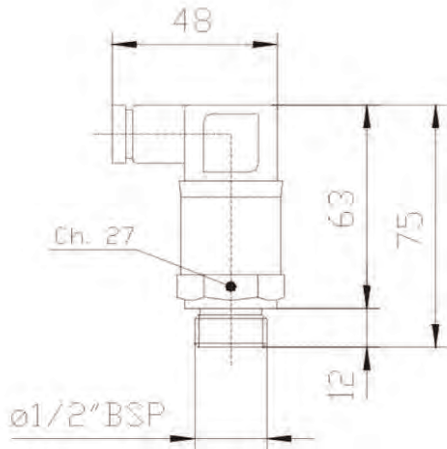

**CARATTERISTICHE ELETTRICHE
ELECTRIC FEATURES**

Attacco elettrico secondo norme DIN 43650

Electric connection according to DIN 43650

Protezione elettrica secondo norme DIN 40050 IP65

Electric protection according to DIN 40050 IP65

Massimo carico sui contatti

Maximum contact load : AC 220V – 10A
AC 125V – 15A
DC 12V – 10A
DC 24V – 5A

Tipo NA Type NO	Taratura Temperature range	Codice Code
TM 44 / A1	40 - 28 °C	0510540
TM 45 / A1	50 - 38 °C	0510550
TM 46 / A1	60 - 48 °C	0510560
TM 47 / A1	70 - 58 °C	0510570
TM 48 / A1	80 - 68 °C	0510580
TM 49 / A1	90 - 78 °C	0510590
Tipo NC Type NC	Taratura Temperature range	Codice Code
TM 44 / C1	40 - 28 °C	0510340
TM 45 / C1	50 - 38 °C	0510350
TM 46 / C1	60 - 48 °C	0510360
TM 47 / C1	70 - 58 °C	0510370
TM 48 / C1	80 - 68 °C	0510380
TM 49 / C1	90 - 78 °C	0510390

TERMOSTATO BIMETALICO A TARATURA FISSA
N.A. IP65
BIMETALLIC FIXED THERMOSTAT
N.A. IP65

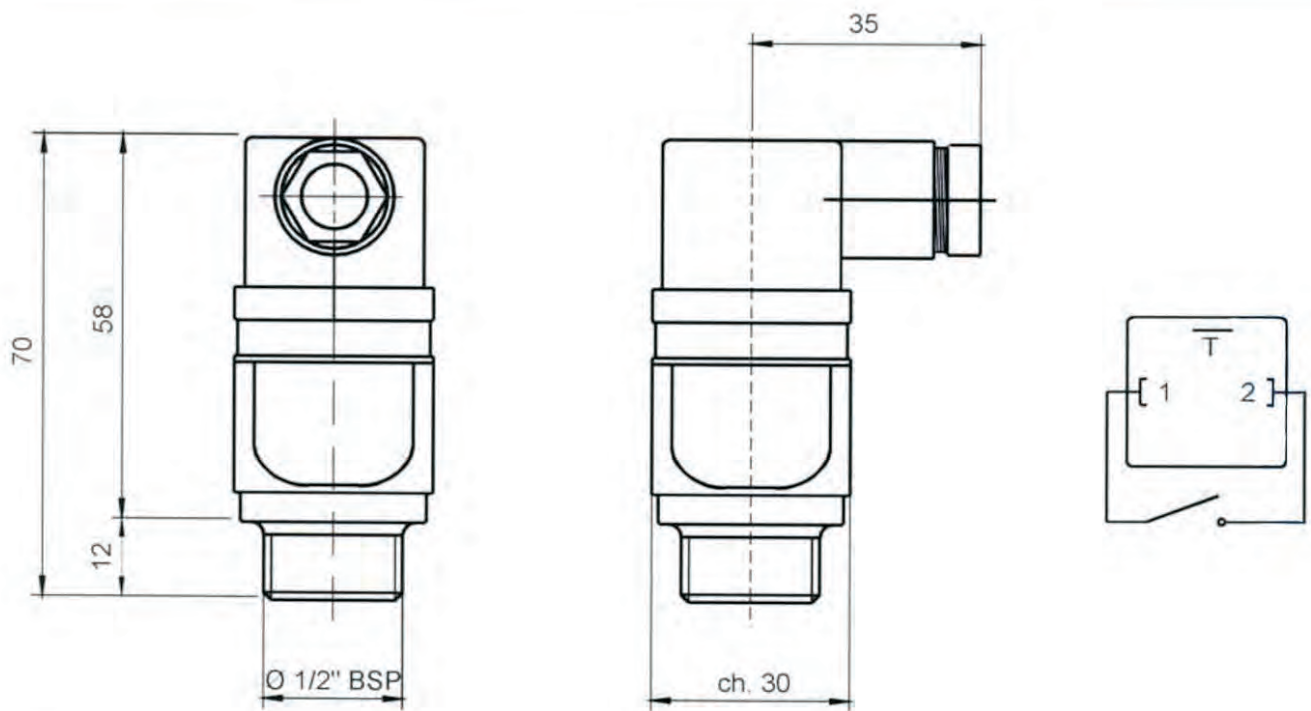

Tipo Type	Temperature range Taratura	Codice code
TM 64	40-28°C	0387300
TM 65	50-38°C	0387310
TM 66	60-48°C	0387320
TM 67	70-58°C	0387330
TM 68	80-68°C	0387340
TM 69	90-78°C	0387350