

Part number:

076-10688a**HYDROMA**

HYDRAULICKÉ SYSTÉMY

**HIDROMA
SYSTEMS**

UKŁADY HYDRAULICZNE

HYDROMA

ГИДРАВЛИЧЕСКИЕ СИСТЕМЫ

ALP2**COME ORDINARE / HOW TO ORDER**

ALP2	TIPO TYPE	ROTAZIONE ROTATION	TAGLIA SIZE	ALBERO* SHAFT*	PORTE* PORTS*	GUARNIZIONI* SEALS*	OPZIONI* OPTIONS*	DRENAGGIO DRAIN
	omit	D DESTRA CLOCKWISE	6					
	A	S SINISTRA COUNTER CLOCKWISE	9					
	BK1	R** REVERSIBILE REVERSIBLE	10					
	BK2		12					
	BK4		13					
	BK7		16					
			20					
			22					
			25					
			30					
			34					
			37					
			40					
			50					

Guarnizioni / Seals
omit (T range = -10°C ÷ 80°C)
V
...

Opzioni / Options
TR
VM
OR***
...

Drenaggio / Drain
E0 = drenaggio interno/internal drain
E1 = drenaggio esterno/external drain G1/4
**** E2 = drenaggio esterno/external drain 9/16-18 UNF
E3 = drenaggio esterno/external drain G3/8 (solo per opzione VM/only for VM options)
**** E4 = drenaggio esterno/external drain 7/16-20 UNF (solo per rotazione R e porte KA/only for R rotation and KA ports)

(*) = campi da specificare se diversi dallo standard "tipo pompa" / to be specified if different from standard pump type
(**) = La rotazione reversibile R è disponibile per tutte le taglie indicate (eccetto 6) / R rotation is available for all listed displacements (except 6)
(***) = solo per tipi pompa A e BK1 / only for A and BK1 pump types
(****) = Le porte di drenaggio sono lavorate secondo la specifica SAE J1926/1 (ISO 11926-1) relativa a porte filettate con tenuta O-ring / Drain ports are machined in compliance with threaded port with O-ring seal in truncated housing SAE J1926/1 (ISO 11926-1)

Tipi Pompa Standard / Pump Standard Types

omit	= flangia europea + albero T0 + porte E + guarnizioni standard / european flange + shaft T0 + ports E + standard seals
A	= flangia A + albero C1 + porte FA + guarnizioni standard / flange A + shaft C1 + ports FA + standard seals
BK1	= flangia BK1 + albero T1 + porte D + guarnizioni standard / flange BK1 + shaft T1 + ports D + standard seals
BK2	= flangia BK2 + albero T2 + porte D + guarnizioni standard / flange BK2 + shaft T2 + ports D + standard seals
BK4	= flangia BK4 + albero T2 + porte D + guarnizioni standard / flange BK4 + shaft T2 + ports D + standard seals
BK7	= flangia BK7 + albero G0 + porte D + guarnizioni standard / flange BK7 + shaft G0 + ports D + standard seals

Esempi / Examples:

ALP2-D-6	= pompa destra, 4.5 cc/rev, flangia europea, albero conico 1:8, porte flangiate tipo E, guarnizioni standard clockwise rotation, 4.5 cc/rev, european flange, 1:8 tapered shaft, flanged ports E type, standard seals
ALP2-D-6-CO	= pompa destra, 4.5 cc/rev, flangia europea, albero cilindrico (CO), porte flangiate tipo E, guarnizioni standard clockwise rotation, 4.5 cc/rev, european flange, cylindrical shaft (CO), flanged ports E type, standard seals
ALP2BK2-D-6-E	= pompa destra, 4.5 cc/rev, flangia tedesca quadrata, albero conico 1:5, porte flangiate tipo (E), guarnizioni standard clockwise rotation, 4.5 cc/rev, german square flange, 1:5 tapered shaft, european flanged ports (E), standard seals
ALP2A-D-6-OR	= pompa destra, 4.5 cc/rev, flangia SAE a 2 fori, albero cilindrico C1, porte filettate FA, guarnizioni standard, guarnizione OR sul colletto clockwise rotation, 4.5 cc/rev, SAE A 2 bolt flange, cylindrical shaft C1, threaded ports FA, standard seal, OR seal on pilot

LE TAVOLE DI PRODOTTO RAPPRESENTANO I TIPI POMPA STANDARD PER MARZOCCHI POMPE. LE TAVOLE SINOTTICHE DI FLANGE, ALBERI E PORTE HANNO LO SCOPO DI RAPPRESENTARE TUTTE LE POSSIBILI CONFIGURAZIONI DI PRODOTTO. PER MAGGIORI DETTAGLI SULLE DISPONIBILITÀ E CONDIZIONI DI FORNITURA, CONSIGLIAMO DI INTERPELLARE IL NOSTRO UFFICIO TECNICO-COMMERCIALE.

THE PRODUCT DATA SHEETS SHOW OUR STANDARD MODEL TYPES. THE SYNOPSIS TABLES FOR FLANGES, SHAFTS AND PORTS SHOW ALL THE POSSIBLE CONFIGURATIONS. FOR FURTHER DETAILS ABOUT THE AVAILABILITY OF EACH CONFIGURATION PLEASE CONTACT OUR SALES AND TECHNICAL DEPT.

Part number:

076-10688b

HYDROMA

HYDRAULICKÉ SYSTÉMY

**HIDROMA
SYSTEMS**

UKŁADY HYDRAULICZNE

HYDROMA

ГИДРАВЛИЧЕСКИЕ СИСТЕМЫ

ALP2A

Parti accessorie a corredo della pompa standard: linguetta (codice 522067).
Monta flangia 82-2 (A) secondo norma SAE J744c.

Le porte standard "D" e "d" sono lavorate secondo la specifica SAE J1926/1 (ISO 11926-1) relativa a porte filettate con tenuta O-ring.

Accessories supplied with the standard pump: key (code 522067).

Mounting flange 82-2 (A) in compliance with SAE J744c.

"D" and "d" standard ports are machined in compliance with threaded port with O-ring seal in truncated housing SAE J1926/1 (ISO 11926-1).

MANDATA
OUTLET

ASPIRAZIONE
INLET

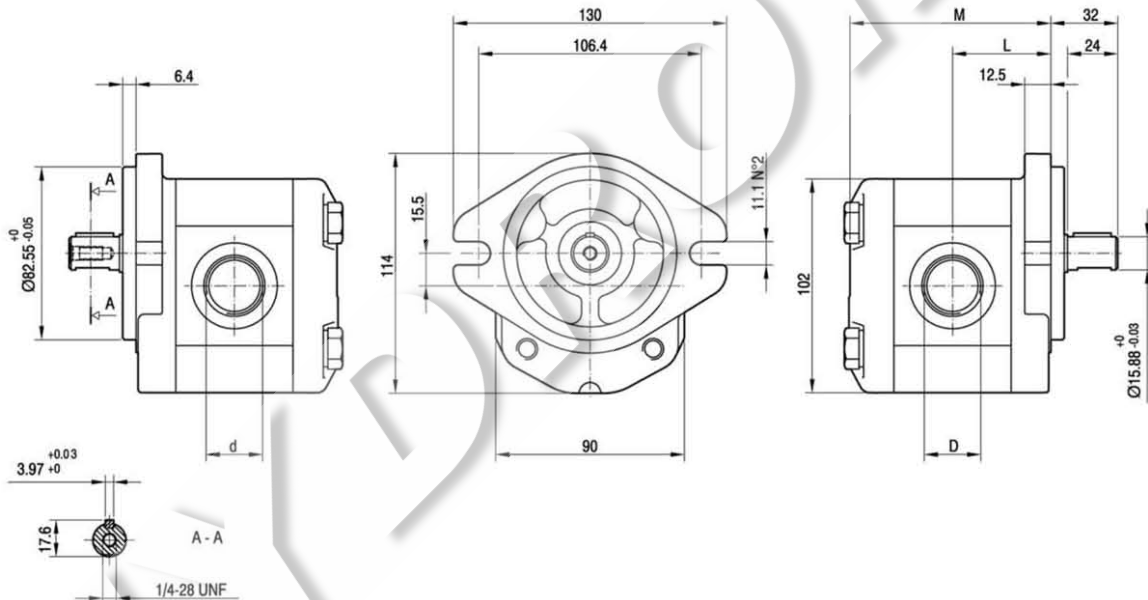

TIPO TYPE	CILINDRATA DISPLACEMENT	PORTATA a 1500 giri/min FLOW at 1500 rev/min	PRESSIONI MASSIME MAX PRESSURE			VELOCITÀ MASSIMA MAX SPEED	DIMENSIONI DIMENSIONS			
			P ₁	P ₂	P ₃		L	M	d	D
	cm ³ /giro [cm ³ /rev]	litri/min [litres/min]	bar	bar	bar	giri/min [rpm]	mm	mm		
ALP2A-D-6	4,5	6,4	250	270	290	4000	45,5	93,5	7/8-14 UNF	1 1/16-12 UNF
ALP2A-D-9	6,4	9,1	250	270	290	4000	47	96,5	7/8-14 UNF	1 1/16-12 UNF
ALP2A-D-10	7,0	10,0	250	270	290	4000	47,5	97,5	7/8-14 UNF	1 1/16-12 UNF
ALP2A-D-12	8,3	11,8	250	270	290	4000	48,5	99,5	7/8-14 UNF	1 1/16-12 UNF
ALP2A-D-13	9,6	13,7	250	270	290	4000	49,5	101,5	7/8-14 UNF	1 1/16-12 UNF
ALP2A-D-16	11,5	16,4	230	250	270	4000	51	104,5	7/8-14 UNF	1 1/16-12 UNF
ALP2A-D-20	14,1	20,1	230	250	270	3200	53	108,5	7/8-14 UNF	1 1/16-12 UNF
ALP2A-D-22	16,0	22,8	210	225	240	2800	54,5	111,5	7/8-14 UNF	1 1/16-12 UNF
ALP2A-D-25	17,9	25,5	210	225	240	2500	56	114,5	7/8-14 UNF	1 1/16-12 UNF
ALP2A-D-30	21,1	30,1	180	195	210	2200	58,5	119,5	7/8-14 UNF	1 1/16-12 UNF
ALP2A-D-34	23,7	33,7	180	195	210	2000	60,5	123,5	7/8-14 UNF	1 1/16-12 UNF
ALP2A-D-37	25,5	36,4	170	185	200	1800	62	126,5	7/8-14 UNF	1 1/16-12 UNF
ALP2A-D-40	28,2	40,1	170	185	200	1800	64	130,5	7/8-14 UNF	1 1/16-12 UNF
ALP2A-D-50	35,2	50,2	140	155	170	2000	69,5	141,5	7/8-14 UNF	1 5/16-12 UNF

Part number:

076-10688c

HYDROMA

HYDRAULICKÉ SYSTÉMY

**HIDROMA
SISTEMS**

UKŁADY HYDRAULICZNE

HYDROMA

ГИДРАВЛИЧЕСКИЕ СИСТЕМЫ

ALP2

FLANGE / FLANGES

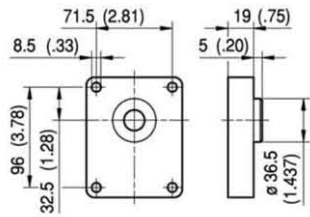

ALBERI / SHAFTS

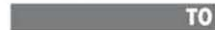
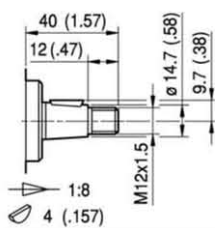

Coppia Max
Max Torque 200 Nm

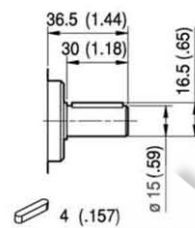

Coppia Max
Max Torque 135 Nm

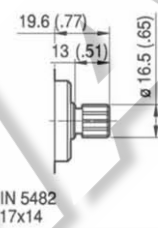

DIN 5482
B17x14

Coppia Max
Max Torque 140 Nm

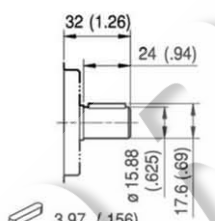
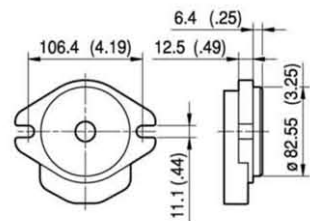

Coppia Max
Max Torque 140 Nm

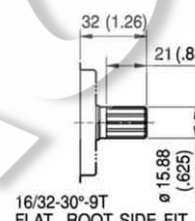

16/32-30°-9T
FLAT ROOT SIDE FIT

Coppia Max
Max Torque 185 Nm

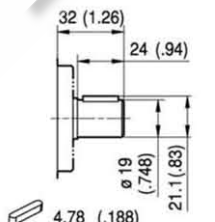

Coppia Max
Max Torque 160 Nm

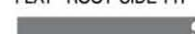
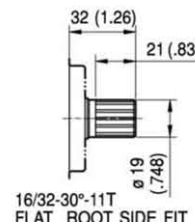

16/32-30°-11T
FLAT ROOT SIDE FIT

Coppia Max
Max Torque 200 Nm

Part number:

076-10688d

HYDROMA

HYDRAULICKÉ SYSTÉMY

**HIDROMA
SYSTEMS**

UKŁADY HYDRAULICZNE

HYDROMA

ГИДРАВЛИЧЕСКИЕ СИСТЕМЫ

ALP2

PORTE / PORTS

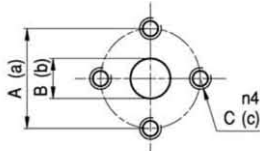

E

TIPO TYPE	ASPIRAZIONE INLET			MANDATA OUTLET		
	A	B	C	a	b	c
ALP2...6 ÷ ALP2...9	30	13	M6	30	13	M6
ALP2...10 ÷ ALP2...13	40	13	M8	40	13	M8
ALP2...16 ÷ ALP2...25	40	19	M8	40	13	M8
ALP2...30 ÷ ALP2...40	40	19	M8	40	19	M8
ALP2...50	40	21	M8	40	19	M8

I valori delle coppie di serraggio delle viti presenti nel kit raccordo sono indicate a pag. 57 (capitolo accessori).
Tightening torques of the fittings screws are specified on page 57 (accessories section).

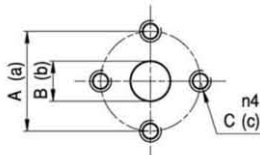

EP

TIPO TYPE	ASPIRAZIONE INLET			MANDATA OUTLET		
	A	B	C	a	b	c
ALP2...10 ÷ ALP2...13	30	13	M6	30	13	M6
ALP2...16 ÷ ALP2...40	40	19	M8	30	13	M6

I valori delle coppie di serraggio delle viti presenti nel kit raccordo sono indicate a pag. 57 (capitolo accessori).
Tightening torques of the fittings screws are specified on page 57 (accessories section).

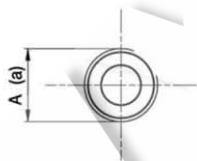

FG

TIPO TYPE	ASPIRAZIONE INLET	MANDATA OUTLET
	A	a
ALP2...6 ÷ ALP2...16	G1/2	G1/2
ALP2...20 ÷ ALP2...50	G3/4	G1/2

Raccordo G1/2 coppia di serraggio massima 50 Nm. Raccordo G3/4 coppia di serraggio massima 60 Nm.
Consigliamo di richiedere conferma al fornitore del raccordo.
Tightening torques for G1/2 fitting: 50 Nm. Tightening torques for G3/4 fitting: 60 Nm. Please check with the fittings suppliers.

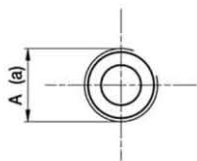

FC

TIPO TYPE	ASPIRAZIONE INLET	MANDATA OUTLET
	A	a
ALP2...6 ÷ ALP2...16	Rc1/2	Rc1/2
ALP2...20 ÷ ALP2...50	Rc3/4	Rc1/2

Raccordo Rc1/2 coppia di serraggio massima 50 Nm. Raccordo Rc3/4 coppia di serraggio massima 60 Nm.
Consigliamo di richiedere conferma al fornitore del raccordo.
Tightening torques for Rc1/2 fitting: 50 Nm. Tightening torques for Rc3/4 fitting: 60 Nm. Please check with the fittings suppliers.

Part number:

076-10688e

HYDROMA

HYDRAULICKÉ SYSTÉMY

**HIDROMA
SYSTEMS**

UKŁADY HYDRAULICZNE

HYDROMA

ГИДРАВЛИЧЕСКИЕ СИСТЕМЫ

Potenza assorbita Absorbed power P [kW]
Momento torcente assorbito Absorbed torque M [Nm]
Velocità di rotazione Drive speed n [giri/min] [rpm]

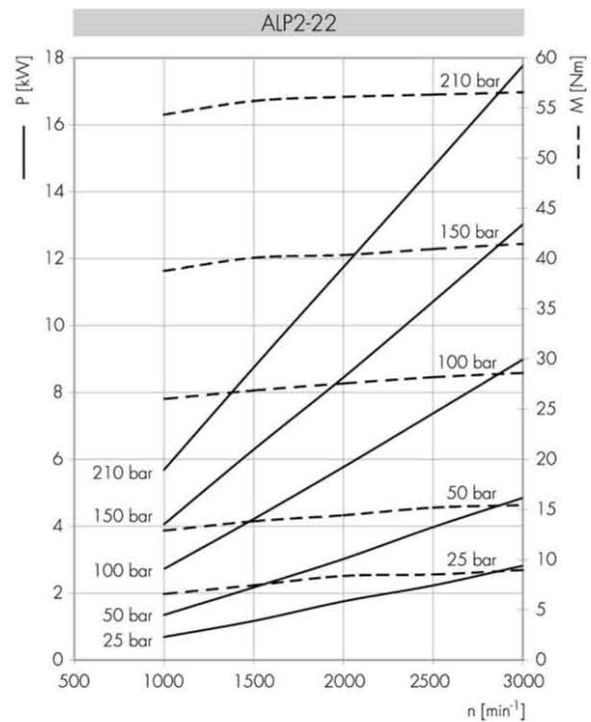
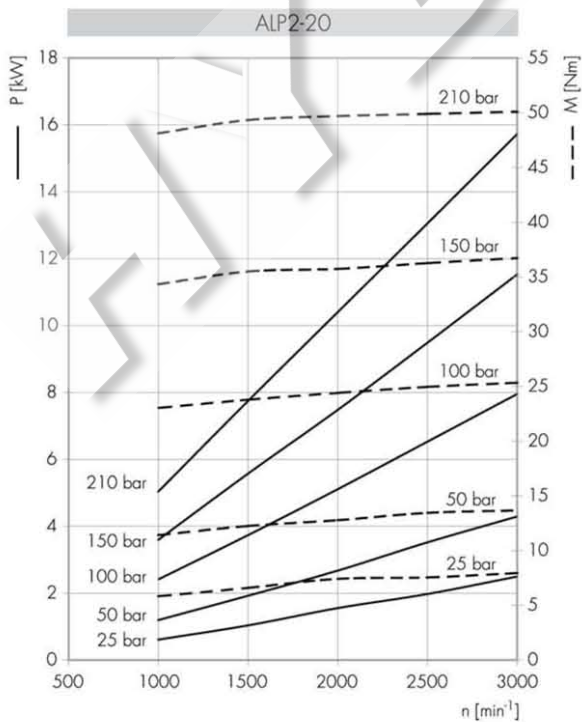
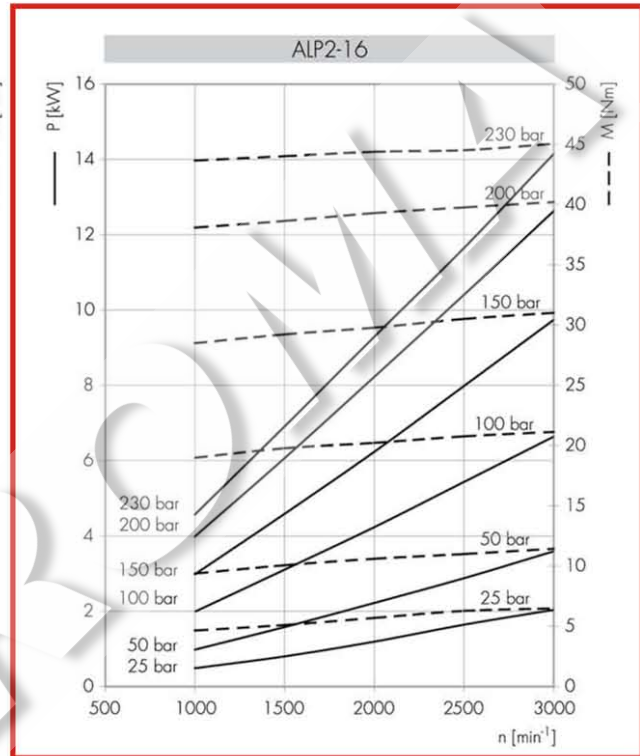
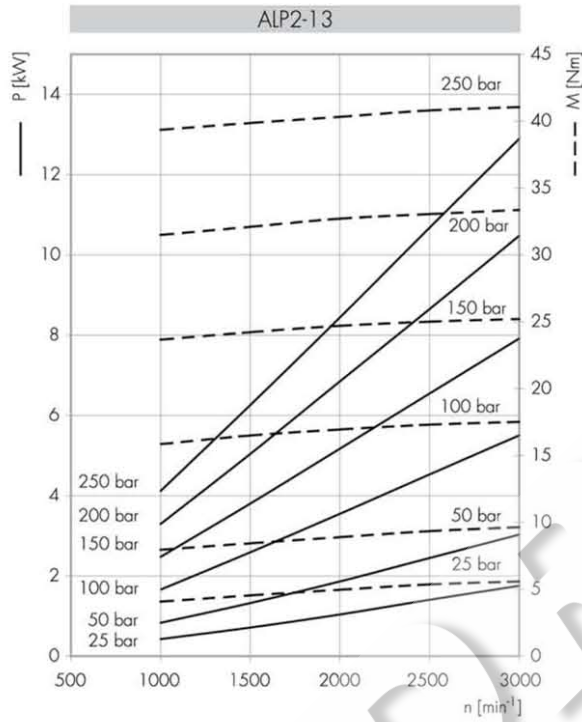

Part number:

076-10688f

HYDROMA

HYDRAULICKÉ SYSTÉMY

**HIDROMA
SYSTEMS**

UKŁADY HYDRAULICZNE

HYDROMA

ГИДРАВЛИЧЕСКИЕ СИСТЕМЫ

GAMMA DI PRODOTTO

Le pompe ad ingranaggi Marzocchi serie ALP sono prodotte in quattro differenti gruppi. All'interno di ognuno, le diverse cilindrata (comprese tra 1.4 e 200 cm³/giro) si ottengono variando lo spessore di fascia dentata dell'ingranaggio.

La nostra gamma di produzione permette di poter scegliere diverse opzioni di flange, alberi o porte d'aspirazione e mandata. Sono inoltre disponibili versioni di:

- pompe reversibili (ROTAZIONE "R")
- pompe con valvola limitatrice di pressione (OPZIONE "VM")

Le cilindrata disponibili sono espresse nel seguente schema:



cilindrata [cm³/giro] - displacement [cm³/rev]

VERSIONI SPECIALI

Sono anche disponibili versioni per utilizzi speciali:

- "V" Versione per impieghi con fluido ad alte temperature. Campo di utilizzo da -10°C a +120°C. Tra -10°C e +80°C sono permesse P1, P2 e P3 come da tabella prodotto; oltre, non eccedere P1.
- "VV" Versione per impieghi con fluido ad alte temperature. Campo di utilizzo da -10°C a +150°C con pressione massima 20 bar.
- "ST" Versione per impieghi con fluido ad alte e basse temperature. Campo di utilizzo da -40°C a +120°C. Tra -10°C e +80°C sono permesse P1, P2 e P3 come da tabella prodotto; al di sotto e oltre, non eccedere P1.
- "H" Versione per impieghi con fluido a basse temperature. Campo di utilizzo da -40°C a +80°C. Tra -10°C e +80°C sono permesse P1, P2 e P3 come da tabella prodotto; al di sotto, non eccedere P1.
- "TR" Versione per impieghi con pressione in aspirazione fino ad un massimo di 6 bar assoluti.

Le qui sopra sigle identificative sono da specificarsi nei campi GUARNIZIONI e/o OPZIONI.

Il nostro Ufficio Tecnico-Commerciale è disponibile a consigliarvi il prodotto più adatto ed è disponibile a considerare ogni condizione d'uso non sia esplicitamente citata in questa pubblicazione.

PRODUCT RANGE

Marzocchi gear pumps of the serie ALP are produced in four different groups. Within each of them, the different displacements (between 1.4 and 200 cm³/rev) are obtained using different width of the gears.

Different flanges, shafts, inlet and pressure ports are available.

The following items are also available:

- reversible pumps (ROTATION "R")
- pumps with pressure limiting valve (OPTION "VM")

Available displacements are indicated below:

SPECIAL VERSIONS

For special uses are also available:

- "V" Version suitable for fluid at high temperatures. Range between -10°C and +120°C. In the range between -10 °C and +80°C pressures P1, P2 and P3 are possible as per the product table; beside that P1 should not be exceeded
- "VV" Version suitable for fluid at high temperatures. Range between -10°C and +150°C with max. pressure = 20 bar
- "ST" Version suitable for fluid at hi- or low-temperature. Range between -40°C and +120°C. In the range between -10 °C and +80°C pressures P1, P2 and P3 are possible as per the product table; beside that P1 should not be exceeded
- "H" Version suitable for fluid at low-temperature. Range between -40°C and +80°C. In the range between -10 °C and +80°C pressures P1, P2 and P3 are possible as per the product table; beside that P1 should not be exceeded
- "TR" Version suitable for inlet pressure up to max. 6 bar absolute.

The above descriptions are to be specified in the field SEAL and/or OPTIONS

Please call our Technical and Sales Depts. for your application requirements and any special use not included in this catalogue.