

Part number:

6 to 14/2 ways/positions bankable flow diverters flangeable L745... (VS281F-VS285F-VS286F-VS287F-VS289F)

RE 18302-10

Edition: 04.2016

Replaces: 05.2014



Size 10
Series 00
Maximum operating pressure 310 bar (4500 psi)
Maximum flow 90 l/min (23.77 gpm)
Ports G 1/2 - SAE10 - M18x1.5 - JIS B 1/2 - M22x1.5

General specifications

6 way 2 position valve.
Directional spool valve with direct solenoid control.
Hydraulic / pneumatic pilot , or manual push and twist control available as option.
Usable as stand-alone, or as multiple stackable units.
Control spool operated by solenoid.
Wet pin tube for DC coil, with push rod for mechanical override in case of voltage shortage.
Unrestricted 360° orientation of DC coil.
Control spool held in normal position by return spring.
Optional manual override (push-button or screw type).
Connectors available: DIN 43650 – ISO 4400, AMP Junior, DT04-2P (Deutsch), Free leads.

Contents

Ordering details	2
Symbols	2
Functional description	3
Technical data	3
Characteristic curves	5
External dimensions and fittings	6
Electric connection	8

Ordering details

01	02	03	04	05	06	07	08	09
L	7	45						

Family

01	Compact directional valve	L
----	---------------------------	---

Type

02	Flow diverters	7
----	----------------	---

Ports

03	G1/2 DIN 3852	4
	7/8-14 UNF (SAE10)	D
	M18x1.5 ISO6149-1	Y
	JIS B 1/2	L
	M22x1,5 DIN 3852	X

Control type

04	Solenoid (coil C65) without manual override	13
	Solenoid (coil C65) with push-button type manual override	1P
	Solenoid (coil C65) with screw type manual override	1F
	Hydraulic / pneumatic control ¹⁾	P1
	Manual push and twist control	H1

Spool variants

05	6 way / 2 position P1 side	6_
----	----------------------------	----

Drain type

	6A	6B	6D	6E	6G	6H	
06	Internal drain	●	●	●	-	●	I
	External drain	●	●	●	-	-	E

Voltage supply

	31	07	03	01	00	
07	Manual push and twist control	-	-	-	-	SG
	Without coil	-	-	-	●	00
	12 V DC	●	●	●	-	OB
	13 V DC	-	●	-	-	AD
	24 V DC	●	●	●	-	OC
	27 V DC	-	●	-	-	AC
	48 V DC	-	-	-	●	OD

Electric connections

08	Without coils	00
	With coils, without mating connector DIN EN 175301-803 ²⁾	01
	With coils, with bi-directional diode, without mating connector vertical Amp-Junior	03
	With coils, with bi-directional diode, without mating connector DT04-2P	07
	With coils and bipolar sheathed lead 350mm (13,8 in) long	31

Assembly

09	Single diverter	0
	2 Pre-assembled diverters	2
	3 Pre-assembled diverters	3
	4 Pre-assembled diverters	4
	5 Pre-assembled diverters	5

● = Available - = Not available

Symbols

Drain type I

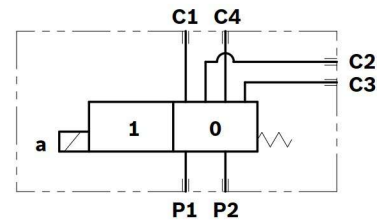

Drain type E

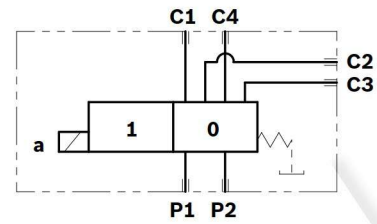

Spool variants

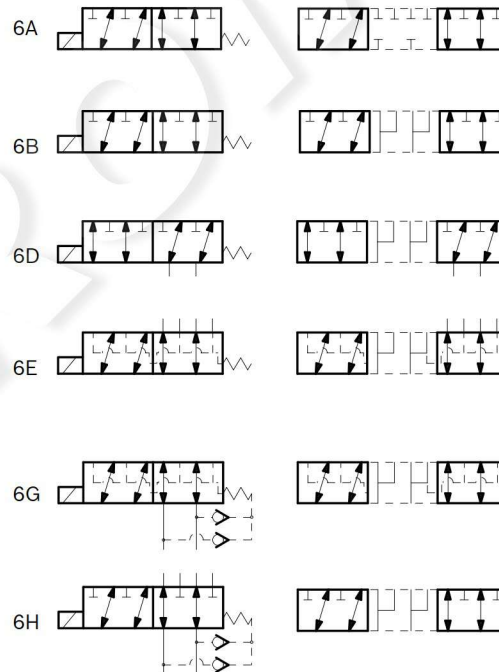

1) Minimum pressure 4 bar (58psi) with external drain (E), maximum pressure 200 bar (2901psi). With internal drain (I), at the minimum pressure (4 bar - 58psi), add the working pressure with ratio of 6,5:1. Example: With working pressure 100 bar (1450psi), minimum pilot pressure is 19.38 bar (281psi) ((100:6,5) + 4 bar (58psi)).

2) For connectors ordering code see data sheet RE 18325-90.

Functional description

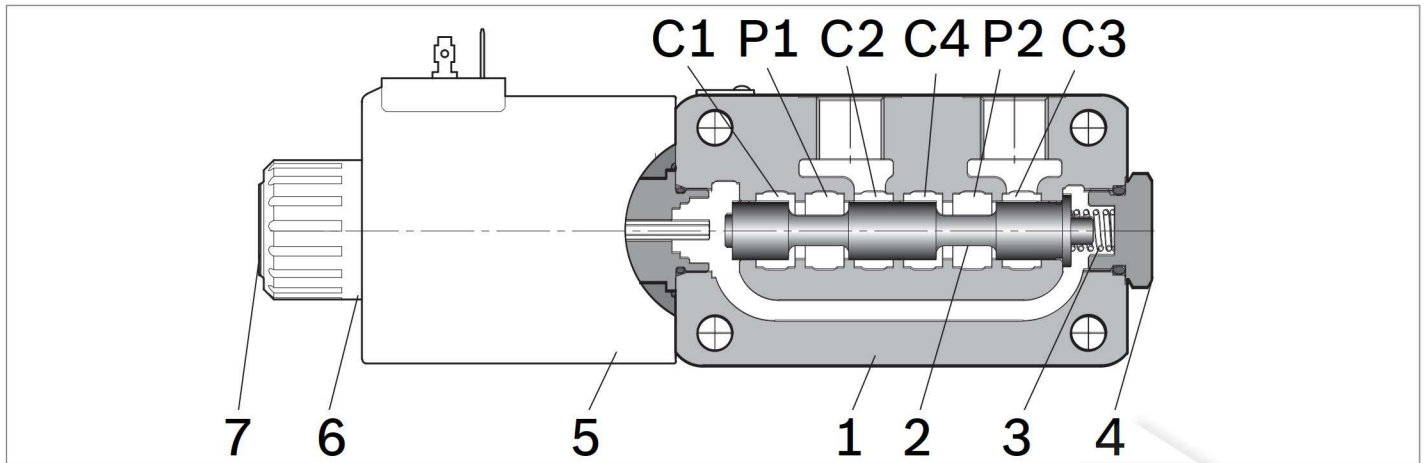

A valve basically consists of a housing (1), a control spool (2), a return spring (3) and a solenoid (5). It is designed to connect two inlet lines P1 – P2 (normally a set of hoses) and divert them to either the outlet ports (C1 – C4) with spool in position “0”, when the solenoid is de-energized, or to the outlet ports (C2 – C3) with spool in position “1”, when the solenoid is energized.

With the coil de-energized, the return spring (3) pushes

back the spool (2) and holds it in position “0”.

The coil (5) is fastened to the tube by the ring nut (6).

The manual override (7) allows to shift the spool (2) also in case of voltage shortage.

An external drain, to be connected to tank, ensures shifting operations also at higher working pressure.

Hydraulic / pneumatic pilot control, or manual push and

twist control for spool shifting are available upon request.

Technical data

General		
Valve weight	kg (lbs)	4.15 (9.15)
Mounting position		unrestricted
Ambient Temperature	°C (°F)	-20....+50 (-4....+122) (NBR seals)
Hydraulic		
Maximum pressure with external drain (“E” type)	bar (psi)	310 (4500)
Maximum pressure with internal drain (“I” type)	bar (psi)	250 (3625)
Maximum flow	l/min (gpm)	90 (24)
Hydraulic fluid		
General properties: it must have physical lubricating and chemical properties suitable for use in hydraulic systems such as, for example:		Mineral oil based hydraulic fluids HL (DIN 51524 part 1). Mineral oil based hydraulic fluids HLP (DIN 51524 part 2). For use of environmentally acceptable fluids (vegetable or polyglycol base) please consult us.
Fluid Temperature	°C (°F)	-20....+80 (-4....+176) (NBR seals)
Permissible degree of fluid contamination		ISO 4572: $\beta_x \geq 75$ X = 12...15 ISO 4406: class 20/18/15 NAS 1638: class 9
Viscosity range	mm ² /s	5....420
Internal leakage with 100 bar (1450 psi) secondary pressure at C	cc/min (in ³ /min)	min.10 (0.61) max. 25 (1.52)

4 **L745... (VS281F-VS285F-VS286F-VS287F-VS289F)** | 6 to 14/2 ways/positions bankable flow diverters flangeable
 Technical data

Electrical						
Voltage type		DC				
Voltage tolerance (nominal voltage)	%	-10 ... +10				
Duty		Continuous, with ambient temperature ≤ 50°C (122°F)				
Coil wire temperature not to be exceeded	°C (°F)	150 (302)				
Insulation class		H				
Compliance with		Low Voltage Directive LVD 73/23/EC (2006/95/EC), 2004/108/EC				
Coil weight with DIN 43650 – ISO 4400 connector	kg (lbs)	1.05 (2.3)				
Voltage	V	12	13	24	27	48
Voltage type		DC	DC	DC	DC	DC
Power consumption	W	44	44	44	44	44
Current (nominal at 20 °C (68 °F))	A	3.6	3.4	1.8	1.6	0.9
Resistance (nominal at 20 °C (68 °F))	Ω	3.2	3.6	12.8	16.9	50.5V

Note

For applications with different specifications consult us.

Code	Voltage [V]	Connector type	Coil description	Marking	Coil Mat no.
OB 01	12 DC	EN 175301-803 (Ex. DIN 43650)	C6501 12DC	12 DC	R933000100
OB 03	12 DC	AMP JUNIOR	C6503 12DC	12 DC	R933000119
OB 07	12 DC	DEUTSCH DT 04-2P	C6507 12DC	12 DC	R933000107
OB 31	12 DC	Cable 350 mm long	C6531 12DC	12 DC	R933000104
AD 01	13 DC	EN 175301-803 (Ex. DIN 43650)	C6501 13DC	13 DC	R933000101
AD 07	13 DC	DEUTSCH DT 04-2P	C6507 13DC	13 DC	R933000112
OC 01	24 DC	EN 175301-803 (Ex. DIN 43650)	C6501 24DC	24 DC	R933000102
OC 03	24 DC	AMP JUNIOR	C6503 24DC	24 DC	R933000120
OC 07	24 DC	DEUTSCH DT 04-2P	C6507 24DC	24 DC	R933000111
OC 31	24 DC	Cable 350 mm long	C6531 24DC	24 DC	R933000110
AC 01	27 DC	EN 175301-803 (Ex. DIN 43650)	C6501 27DC	27 DC	R933000103
AC 03	27 DC	AMP JUNIOR	C6503 27DC	27 DC	R93307055
AC 07	27 DC	DEUTSCH DT 04-2P	C6507 27DC	27 DC	R933000113
OD 01	48 DC	EN 175301-803 (Ex. DIN 43650)	C6501 48DC	48 DC	R933000114

Characteristic curves

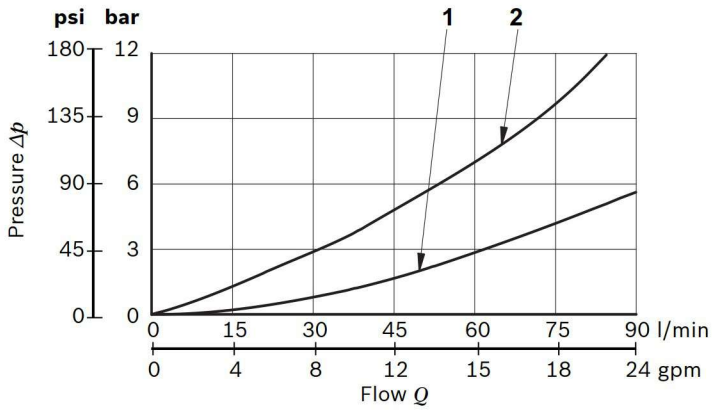

Flow path	Curve no.
P1 > C1	1
P1 > C2	2
P2 > C1	2
P2 > C4	1

Measured with hydraulic fluid ISO-VG32 at 45° ±5 °C (113° ±9 °F); ambient temperature 20 °C (68 °F).

DI-DE performance limits

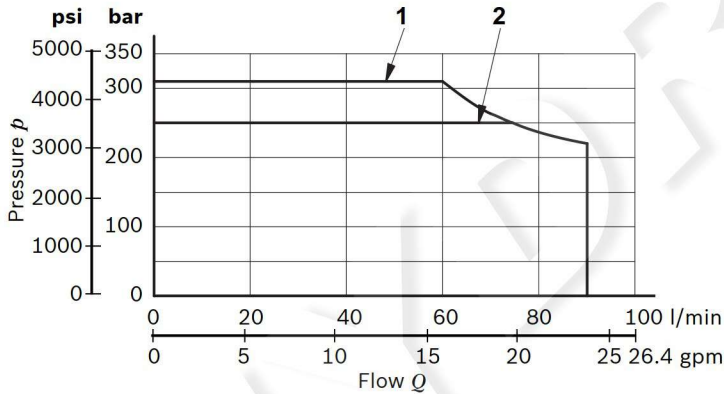
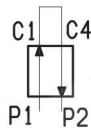

Drain type	Curve No.
External (-E-)	1
Internal (-I-)	2

Flow across both ways: forward across P1>C1 and reverse across C4>P2

External dimensions and fittings

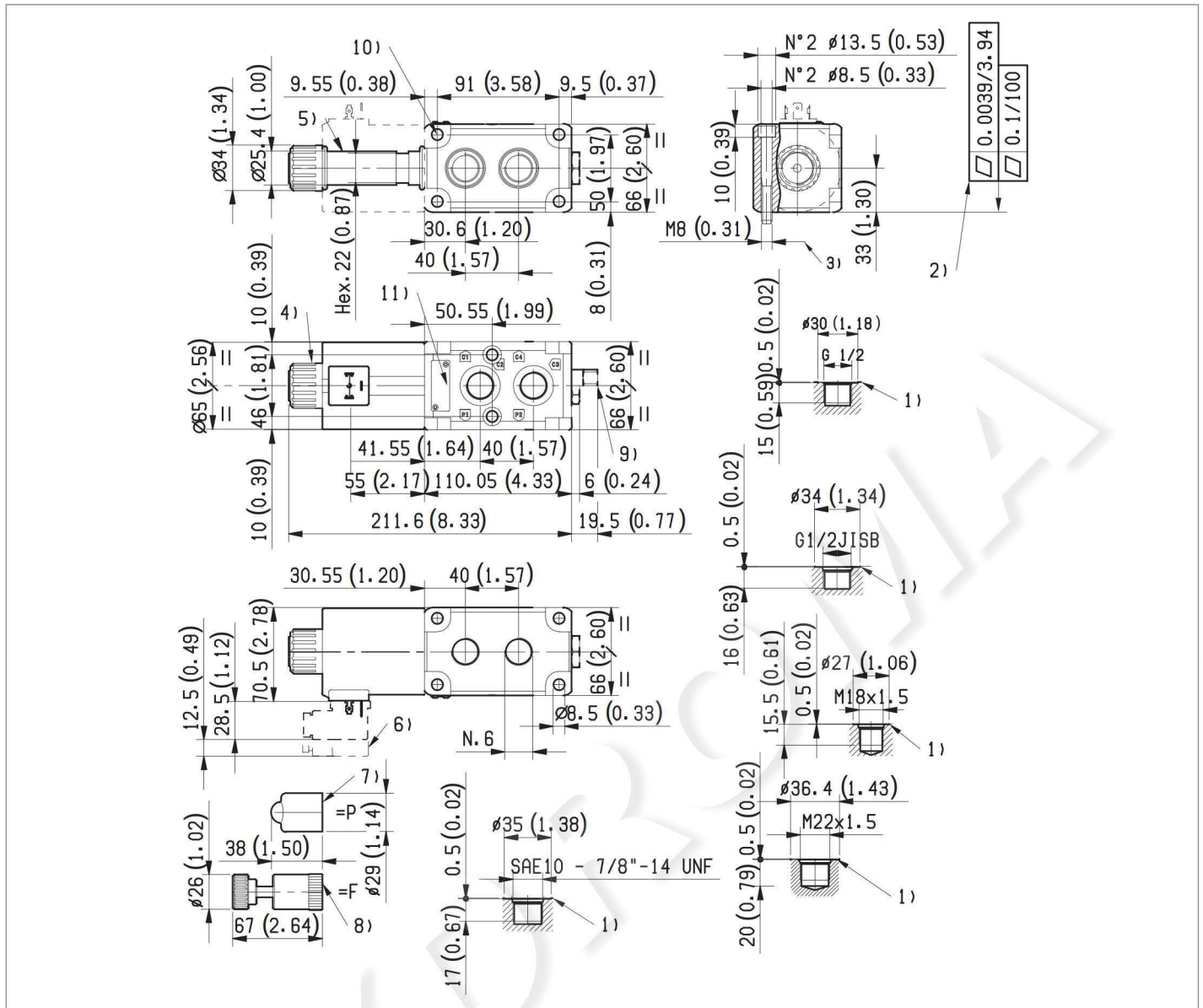

- 1 Ports P1, P2, C1, C2, C3, C4.
- 2 The mounting surface flatness must comply with specifications.
- 3 Two through installation holes recommended screws M8x65 DIN 912 with strength class DIN 8.8.
Torque 15-16 Nm (11.1 – 11.8 ft-lb).
- 4 Ring nut for coil locking OD 34 mm (1.34 inch).
Torque 7-8 Nm (5,25,9 ft-lb).
- 5 Solenoid tube Ø 25,4 mm (1 inch).
- 6 Minimum clearance needed for connector removal.
- 7 Optional push-button, 1P type, manual override for spool opening:
it is pressure stuck to the ring nut for coil locking.
Mat no. R933003424.
- 8 Optional screw, 1F type, manual override for spool opening: it is screwed (torque 8-9 Nm (5.9-6.6 ft-lb)) to the tube as replacement of the coil ring nut.
Mat no. R933003713.
- 9 External drain plug with G 1/4 and SAE 4 port.
- 10 Four through holes, 8.5 mm dia., for coupling of other similar diverter valve.
- 11 Identification label.

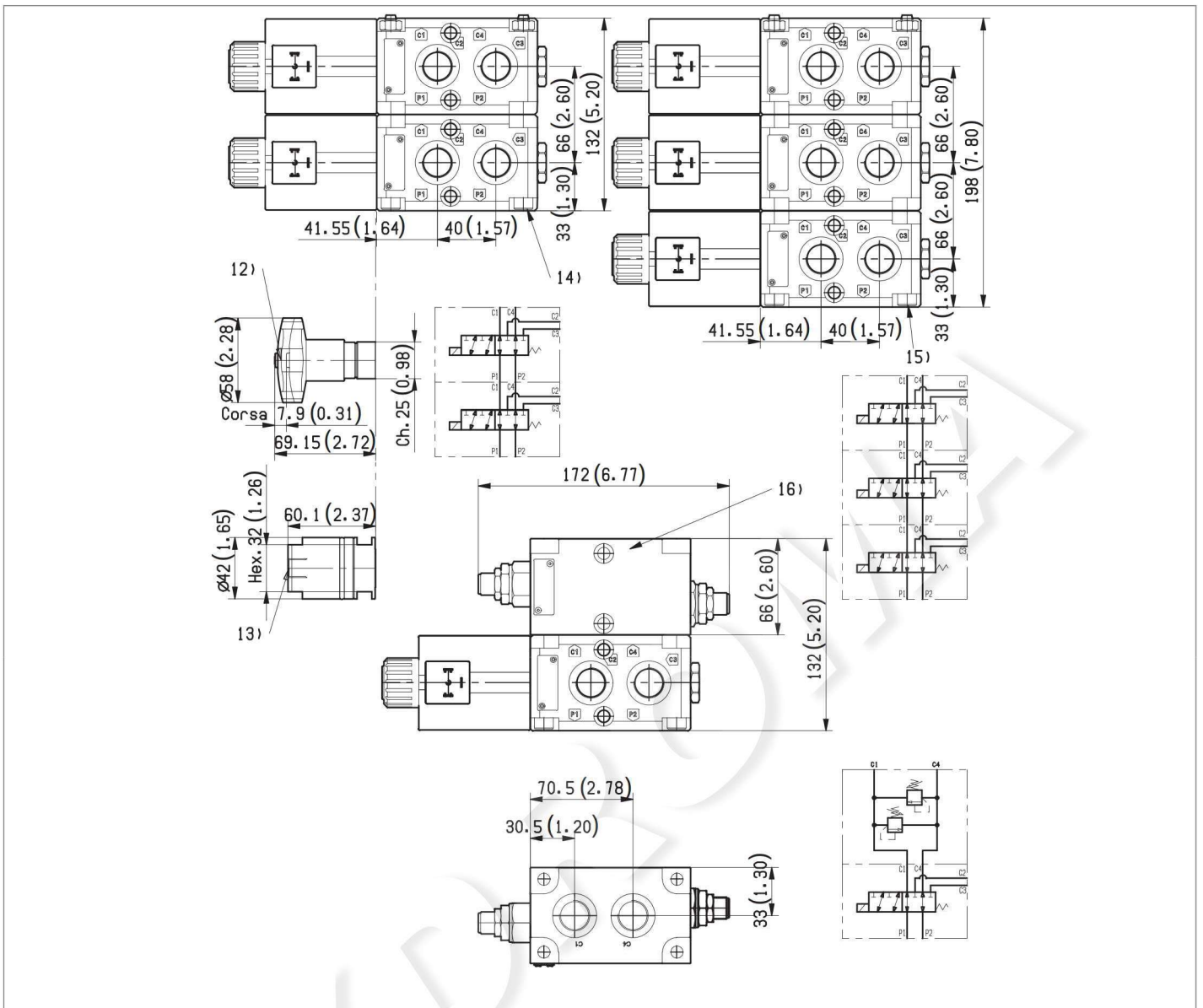

- 12** Manual version, push and twist type.
- 13** Hydraulic / pneumatic piloted version. Pilot port plug available with G 1/4 and SAE4.
- 14** Four screws M8x125 DIN 912 for assembly of 2 units; strength class DIN 8.8. Torque 15-16 Nm (11.1 – 11.8 ft-lb).
- 15** Four screws M8x190 DIN 912 for assembly of 3 units; strength class DIN 8.8. Torque 15-16 Nm (11.1 – 11.8 ft-lb).
- 16** Modular relief valves (cartridges VMD1070SV): with G 1/2 ports, code L7404610214SV00 with SAE 10 ports, code L740D610214SV00. Max pressure 250 bar (3625psi).

Total stacked units	Total Ports	Total length	Bolts (v) or Tie Rods (t)	Torque Nm / (ft-lb)
2	8	132 (5.2)	M8x125 (v)	16-18 / (11.8-13.2)
3	10	198 (7.8)	M8x190 (v)	16-18 / (11.8-13.2)
4	12	264 (10.4)	M8x270 (t)	16-18 / (11.8-13.2)
5	14	330 (13.0)	M8x330 (t)	16-18 / (11.8-13.2)

Electric connection

