

Part number:

**006-10551**

**HYDROMA**

HYDRAULICKÉ SYSTÉMY

**HIDROMA  
SYSTEMS**

UKŁADY HYDRAULICZNE

**HYDROMA**

ГИДРАВЛИЧЕСКИЕ СИСТЕМЫ

**VSBN-08A**

**04.11.49 - X - 56 - Z**

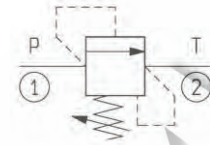
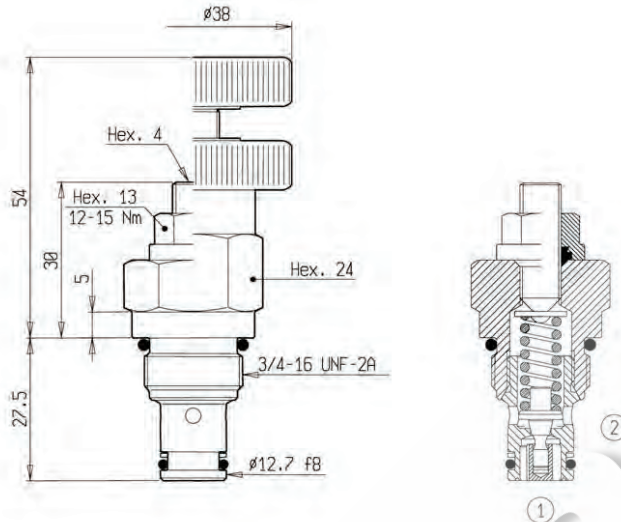

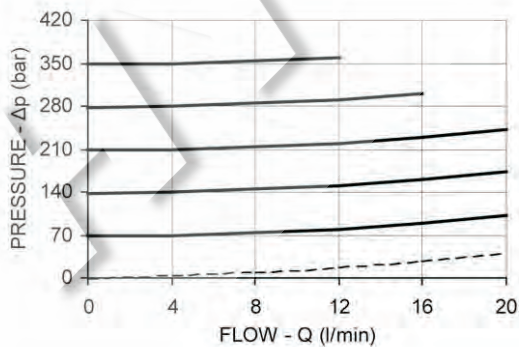

**TECHNICAL DATA**

Max. pressure :	350	bar
Max. flow :	20	l/min
Cavity – Tooling (page 10.010) :	CA-08A-2N	
External seals kit :	see page 11.011	
Installation torque :	27-30	Nm
Weight :	0.140	kg



**X ADJUSTMENTS**

<b>03</b>	Leakproof hex. socket screw	
<b>04</b>	Handknob and locknut	

**Z**

**SPRINGS**

		Adj. press. range bar	Press. increase bar/turn	Standard setting bar (Q=5 l/min)		
<b>X = 03</b>	<b>05</b>	10-70	26	50		
	<b>10</b>	35-140	50	100		
	<b>20</b>	105-210	79	200		
	<b>35</b>	175-350	170	350		
<b>X = 04</b>	<b>35</b>	35-350	72	200		