

Part number:

**HYDROMA**

HYDRAULICKÉ SYSTÉMY

**HIDROMA  
SYSTEMS**

UKŁADY HYDRAULICZNE

**HYDROMA**

ГИДРАВЛИЧЕСКИЕ СИСТЕМЫ

Hydraulic remote control

### HC-RCX - 2 axis single lever remote control



#### Technical specifications

Max pressure: **100 bar**

Oil capacity: **12 l/min**

Weight: **2,5 Kg**

#### Applications

Mini-excavators, Mini steer loaders, Backhoe loaders,  
Wheel loaders, Tractors, Boom mowers

Hydraulic remote control HC-RCX belongs to wide range of Hydrocontrol'e Remote Control; the lever's anti-swaying system and the ergonomic handle provides great sensitivity while manoeuvring and makes his use very comfortable for the operator. Low operating efforts, low energy consumption and low maintenance make these hydraulic remote controls HC-RCX ideal for piloting remote control directional valves, variable displacement pumps and motors, auxiliary valves, frictions and hydraulic brakes.

#### Dimensions

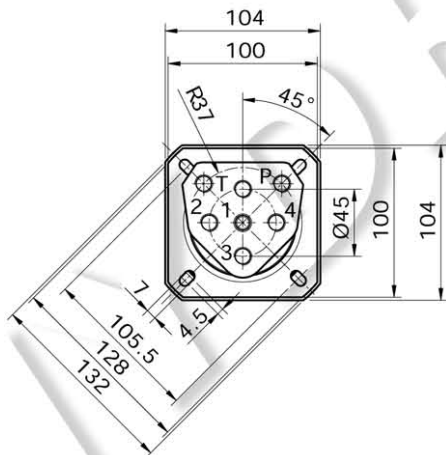

HYDRAULIC SCHEMA

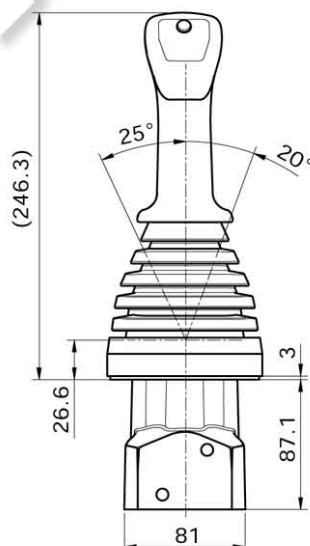
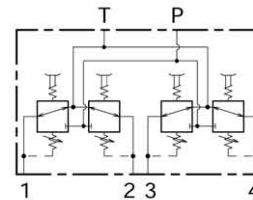

HOLDER HOLE DIMENSION

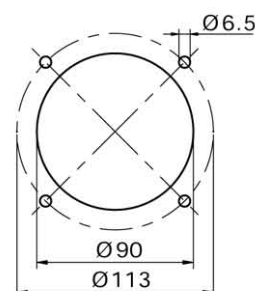

**HC-RCX order example**

**HC-RCX: 03 - A01 - MA - F 05F 00R (2) - WF53 - RA G02**

- TYPE:** \_\_\_\_\_  
 RCX product type
- 1) CONTROL CLASSIFICATION:** \_\_\_\_\_  
 1.1 **03** control type
- 2) METERING CURVE:** \_\_\_\_\_  
 2.1 **A01** curve type
- 3) RETURN SPRING:** \_\_\_\_\_  
 3.1 **MA** return spring type
- 4) HANDLE CLASSIFICATION:** \_\_\_\_\_  
 4.1 **F** handle type  
 4.2 **05F** front buttons arrangement  
 4.3 **00R** rear buttons arrangement  
 4.4 **(2)** handle position compared to ports
- 5) LEVER ROD CLASSIFICATION:** \_\_\_\_\_  
 5.1 **WF** lever rod type  
 5.2 **53** lever rod length
- 6) BODY ARRANGEMENT:** \_\_\_\_\_  
 6.1 **RA** body specification  
 6.2 **G02** body thread

Ordering row 2 and 3, must be repeated for each port  
 complete sample: **HC-RCX 03 A01 MA A01 MA A01 MA A01 MA F 05F 00R 2 WF53 RA G02**

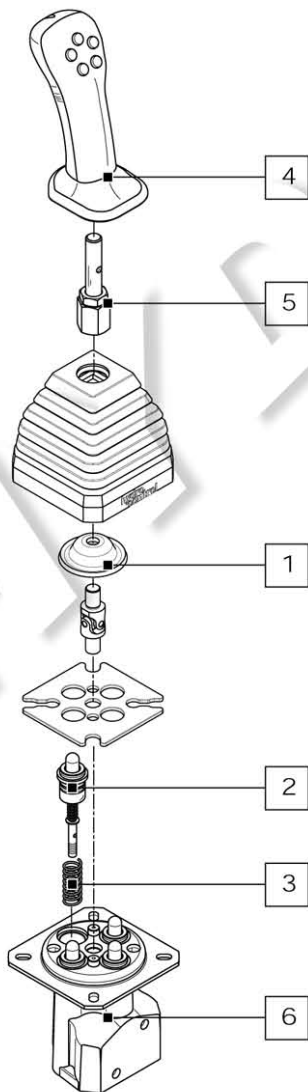

**1) CONTROL CLASSIFICATION: (pag. 14)**

- 01** Return spring in neutral
- 02** Return spring in neutral with detent in only one service port
- 03** Return spring in neutral with square bellows for straight lever rod
- 04** Return spring in neutral with square bellows for bent lever rod

**2) METERING CURVE: (pag. 72)**

- A01** Linear metering curve with step
- B01** Linear metering curve without step
- C01** Broken line metering curve with step
- D01** Broken line metering curve without step

**3) RETURN SPRING: (pag. 79)**

- MA** Preload 25 N      End stroke load 48 N
- MB** Preload 14 N      End stroke load 27 N
- MC** Preload 73 N      End stroke load 135 N
- MD** Preload 89 N      End stroke load 169 N

**4) HANDLE CLASSIFICATION: (pag. 80)**

- A** Without micro-switch
- B** With micro-switch to close
- C** With micro-switch to close with detent
- D** With dual micro-switch
- F** Ergonomic handle
- G** Ergonomic handle
- S** Ergonomic handle slim
- K** Spherical handle

**5) LEVER ROD CLASSIFICATION: (pag. 15)**

Levers depends on the handle and on the required control:  
**WF53** Straight standard lever for "F" handle  
**WG51** Bented standard lever for "F" handle

**6) BODY ARRANGEMENT: (pag. 17)**

- RA G02** Standard Body (G 1/4 ports)
- RA U02** Standard Body (9/16"-18 UNF ports)
- RB G02** Body with shuttle valve for translation (G 1/4 ports)
- RB U02** Body with shuttle valve for translation (9/16"-18 UNF ports)

Control kit classification

All controls installed on the remote control HC-RCX are interchangeable. Lever rod type must be chosen according to different control kit (see quick reference guide pag.15-16).  
The controls shown correspond to standard configurations; for different applications contact our Commercial Dept.

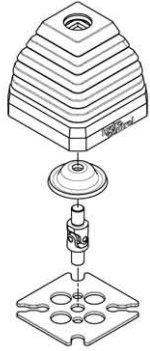
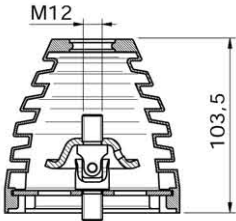
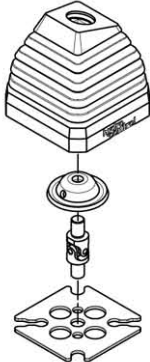
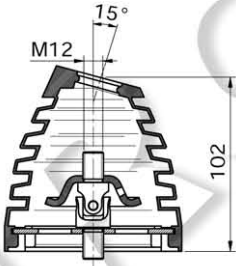
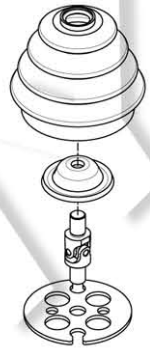
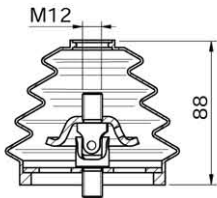
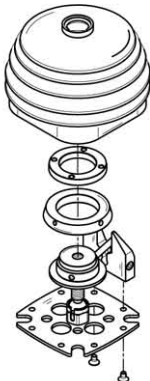
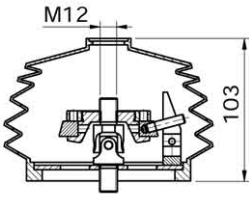
CODE	CONFIGURATION	DIMENSIONS	DESCRIPTION
03			<p>Return spring in neutral with square bellows for straight lever rod</p>
04			<p>Return spring in neutral with square bellows for bent lever rod</p>
01			<p>Return spring in neutral with round bellows</p>
02			<p>Return spring in neutral with detent in only one service port</p> <p><b>NOTE:</b> user port where to apply mechanical detent must be specified</p>

## Hydraulic remote control



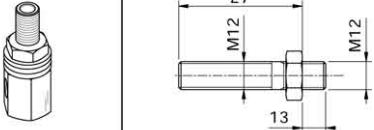
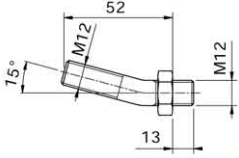
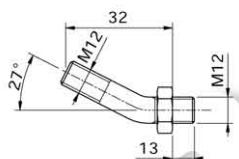

### Lever rod classification

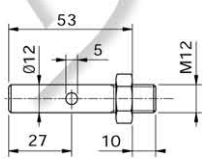
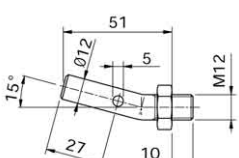
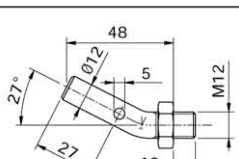
The lever rod kits applied to all the HC-RCX hydraulic remote controls designed by Hydrocontrol change according to the type of control used and, above all, the type of handle. For improved clarity, all the possible lever rod configurations divided according to handle are listed here below. Straight and curved lever rods are available in several lengths and dimensions.

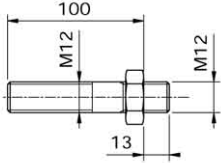
IDENTIFICATION ROD LEVER HANDLE "A-B-C-D" - QUICK REFERENCE GUIDE					
Code	Dimensional drawing	Comando 01	Comando 02	Comando 03	Comando 04
WA27		•	•		
WB52		•	•		
WD32		•	•		

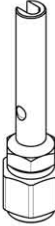
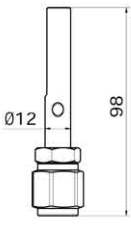
IDENTIFICATION ROD LEVER HANDLE "F" - QUICK REFERENCE GUIDE					
Code	Dimensional drawing	Control 01	Control 02	Control 03	Control 04
WF53		•	•	•	
WG51		•	•		•
WH48		•	•		•

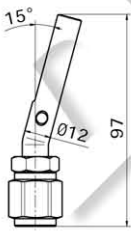
IDENTIFICATION ROD LEVER HANDLE "K" - QUICK REFERENCE GUIDE						
Code		Dimensional drawing	Control 01	Control 02	Control 03	Control 04
<b>WE100</b>			•	•		

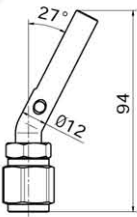
IDENTIFICATION ROD LEVER HANDLE "S" - QUICK REFERENCE GUIDE						
Code		Dimensional drawing	Control 01	Control 02	Control 03	Control 04
<b>WS76</b>			•	•	•	
<b>WT69</b>			•		•	•
<b>WU65</b>			•		•	•

## Hydraulic remote control

### Body arrangement

The remote hydraulic HC-RCX body has two versions: standard body and body with shuttle valve for translation.

The set-up for translation applications (code: RB) includes a flanged plate with internal shuttle valves allowing a single service port control to be split between two ports. In this way, action on the lever will generate two separate pressure signals, allowing dedicated machine translation devices to be controlled.

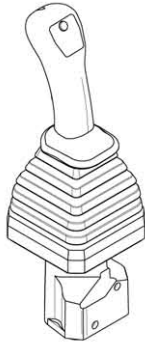
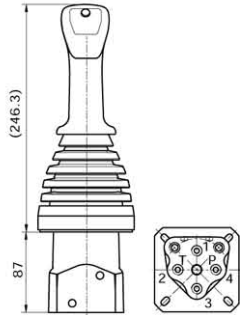
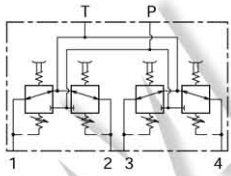
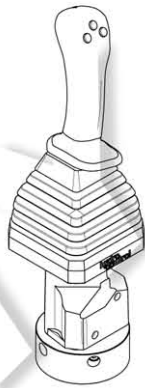
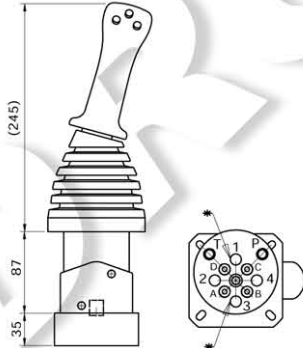
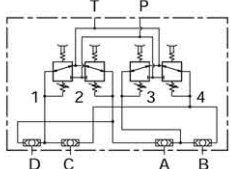
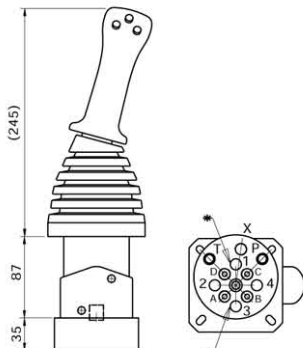
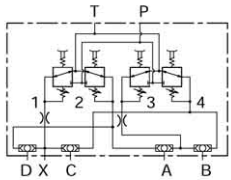
CODE	CONFIGURATION	DIMENSIONS	SCHEMA	DESCRIPTION
<b>RA G02</b>				<b>Standard body</b> with ports G 1/4
<b>RA U02</b>				<b>Standard body</b> with ports 9/16" - 18 UNF
<b>RB G02</b>				<b>Body with shuttle valve for translation</b> with ports G 1/4
<b>RB U02</b>				<b>Body with shuttle valve for translation</b> with ports 9/16" - 18 UNF
<b>RB01 G02</b>				<b>Body with shuttle valve for translation with auxiliary port (X) for Alert</b> with ports G 1/4
<b>RB01 U02</b>				<b>Body with shuttle valve for translation with auxiliary port (X) for Alert</b> with ports 9/16" - 18 UNF

As an alternative to the "RB01" version, other set-ups are available with different flow restrictor diameters and configurations on the service ports; for more information contact our Commercial Dept.

## Return spring classification

For all the servo control configurations designed by Hydrocontrol, in each service port and on the relevant metering curve, a return spring must be selected.

The exploded view here below shows the example configuration of a 4 service port remote control; as you can see, a return spring is pictured at each metering curve. 4 types of return spring are currently available (see table).

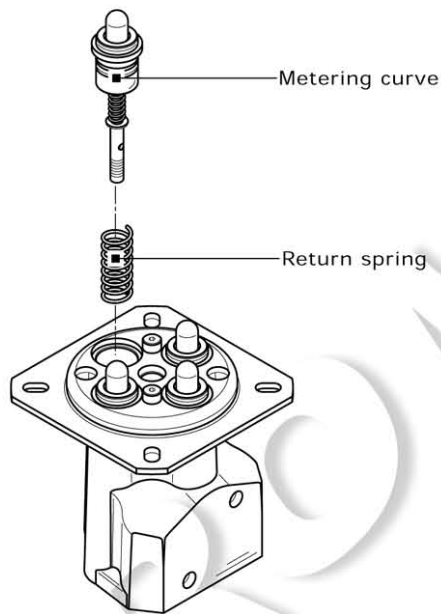

CODE	PRELOAD	END STROKE LOAD
<b>MA</b>	25 N	48 N
<b>MB</b>	14 N	27 N
<b>MC</b>	73 N	135 N
<b>MD</b>	89 N	169 N







## Return spring classification for HC-RCS e HC-RCT

The range of RCS and RCT tilting foot controls only includes the MD type return spring. The relative values are shown here below.

CODE	PRELOAD	END STROKE LOAD
<b>MD</b>	94 N	149 N

## Handles classification

All the hydraulic remote controls manufactured by Hydrocontrol can be set up to have different handles according to the system dimensions and applications. All the handles in the range are shown here below; for each handle, the corresponding operation is also pictured. The choice of a handle will also influence the choice of a lever kit.

HANDLE IDENTIFICATION - QUICK REFERENCE GUIDE								
Type	Description	RCX	RCY	RCL	RCL3	RCM	RCB	
<b>A</b>		•	•			•		
<b>B</b>	Handle with micro-switch to close	•	•			•		
<b>C</b>		•	•			•		
<b>D</b>	Handle with dual micro-switch	•	•			•		
<b>F</b>		•	•	•	•			
<b>M</b>						•	•	
<b>S</b>		•	•	•				
<b>T</b>		•	•	•	•			
<b>K</b>		•	•					



## Handles "A - B - C - D"

The handle families identified with A, B, C and D have been designed to equip the vast range of earth-moving machines including mini-excavators, mini-loaders, brush cutters, backhoe loaders, tractors, etc.

These handles can be set up to have – or not – a microswitch.

The hydraulic remote controls most suitable for fitting these handles are HC-RCX, HC-RCY and HC-RCM.

TYPE	DESCRIPTION	DIMENSIONS	CONFIGURATION
<b>A</b>	without micro-switch (standard)		
<b>B</b>	with micro-switch to close		
<b>C</b>	with micro-switch to close with detent		
<b>D</b>	with dual micro-switch		



## Handles microswitch breaking B - C - D

MICROSWITCH SPECIFICATIONS	
Direct current load resistive	4.8 A 30 Vdc
Alternative current load resistive	1.5 A 30 Vdc
TECHNICAL SPECIFICATIONS	
Hande protection	IP 40

## Handle "F"

This handle has been designed to be used on our remote controls type RCX. Its ergonomics, the accurate buttons position and dimensions make its use comfortable and restful.

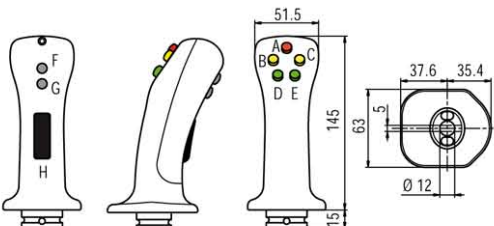
It can be supplied with 7 microswitches in different combinations together with a push button for safety.

TYPE	DESCRIPTION	DIMENSIONS	CONFIGURATION
<b>F</b>	Ergonomic handle		

## Technical specifications

BUTTONS COLOURS	
Type A	red
Type B - C	yellow
Type D - E	green
Type F - G	grey
Type H (push button for safety)	black
MICROSWITCH SPECIFICATIONS	
Direct current load resistive	5 A 30 Vdc
Direct current load inductive	3 A 30 Vdc
TECHNICAL SPECIFICATIONS	
Handle protection	IP 65
Cable section	0,5 mm <sup>2</sup>
Useful cable length	700 mm

## Order example handle "F"

handle F: 05F - 01R - 2 - WF53

### 1) FRONT BUTTONS ARRANGEMENT:

**05F** arrangement with 5 front buttons

### 2) REAR BUTTONS ARRANGEMENT:

**01R** arrangement with 1 rear button

### 3) HANDLE POSITION (respect to the body):

**2** return spring type

### 4) LEVER ROD CLASSIFICATION:

**WF53** type and length rod lever straight

**WG51** type and length rod lever bent

**WH48** type and length rod lever bent

FRONT BUTTONS ARRANGEMENT		
Code	Drawing	Schema
00F		
01F		
02F		
03F		
04F		
05F		

REAR BUTTONS ARRANGEMENT		
Code	Drawing	Schema
00R		
01R		
02R		
03R		
04R		
05R		

## Metering curve classification

All the Hydrocontrol servo control configurations imply the choice of a "metering curve" kit; the number of metering curves changes according to the number of product service ports. The metering curve classification depends on the working pressure (measured in bars) and stroke length (measured in mm).

The sketch here below shows a typical metering curve and the list of available curves.

For information on the complete list of curves, contact the manufacturer's Commercial department.

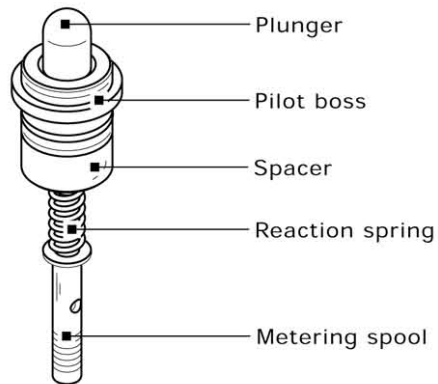

TYPE	DIAGRAM		DESCRIPTION	
<b>A</b>	Pressure (bar) Stroke (mm)		Linear metering curve <b>with step</b>	
CODE	PRESSURE		STROKE	
	A (bar)	B (bar)	C (mm)	D (mm)
<b>A01</b>	5,8	19,5	1,5	7,5
<b>A02</b>	5	25	1,5	7,5
<b>A03</b>	2	13	1,5	7,5
<b>A04</b>	6	40	1,5	7,5
<b>A05</b>	0	64	1,5	7,5
<b>A06</b>	4	17	1,5	7,5
<b>A07</b>	5	15	1,5	7,5
<b>A08</b>	2	18	1,5	7,5
<b>A09</b>	5	20	1,5	6
<b>A10</b>	2	8	1,5	7,5
<b>A11</b>	4	10	1,5	7,5
<b>A12</b>	11,5	32	1,5	7,5
<b>A13</b>	10	20	1,5	7,5
<b>A14</b>	7	17	1,5	7,5
<b>A15</b>	7,5	29	1,5	7,5

**HANDLE POSITION "F" (respect to the body)**

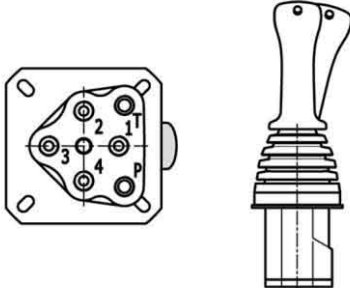
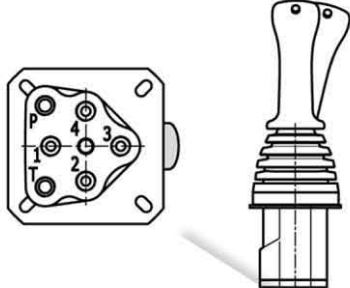
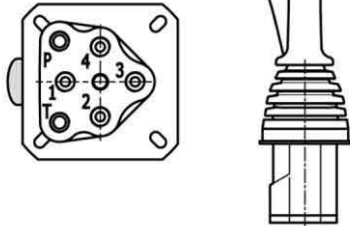
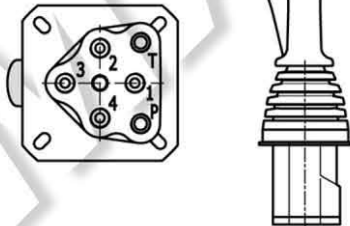
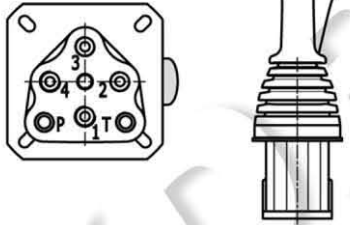
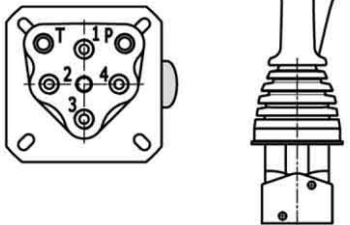
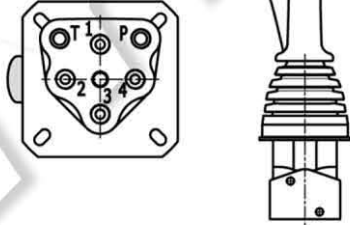
Code	Configuration	Code	Configuration
1		5	
2		6	
3		7	
4		8	