

Part number:

HYDROMA

HYDRAULICKÉ SYSTÉMY

**HIDROMA
SYSTEMS**

UKŁADY HYDRAULICZNE

HYDROMA

ГИДРАВЛИЧЕСКИЕ СИСТЕМЫ

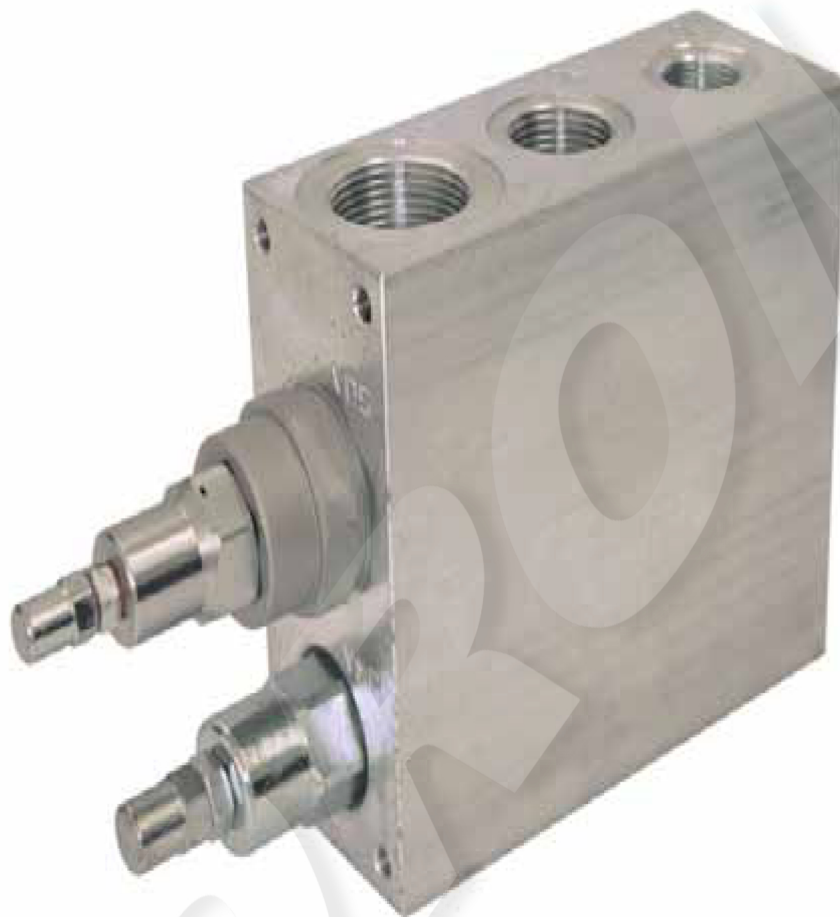

Bestellnr.	Typ	Bezeichnung	Gehäuse	max. Betriebsdruck bar	max. Durchfluss l/min	Code
230-0420-1655	VEP 114/TS-TV.S	1 1/4"-Einstellb. 50-220+20-80bar-Hutmutter	Alu	210	250 (200 + 80)	1220061100
230-0420-1660	VEP 114/TR-TV.S	1 1/4"-Einstellb. 180-350+20-80bar-Hutmutter				1220061101
230-0420-1665	VEP 114/TR-TS.S	1 1/4"-Einstellb. 180-350+50-220bar-Hutmutter				1220061102
230-0420-1670	VEP 114/TR-TV.S/ac	1 1/4"-Einstellb. 180-350+20-80bar-Hutmutter	Stahl	350		1220062100
230-0420-1675	VEP 114/TR-TS.S/ac	1 1/4"-Einstellb. 180-350+50-220bar-Hutmutter				1220062101

SEQUENCE
VEP 114

• DIMENSIONS (mm)

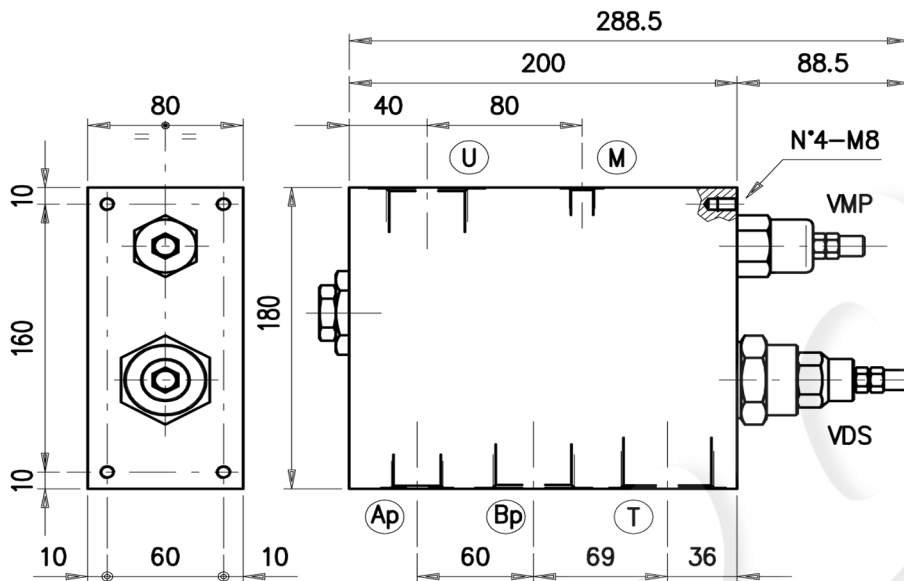

VEP	U	M	T	Ap	Bp
114	G 1" 1/4	G 1/4	G 1" 1/2	G 3/4	G 1" 1/4

• HYDRAULIC DIAGRAM

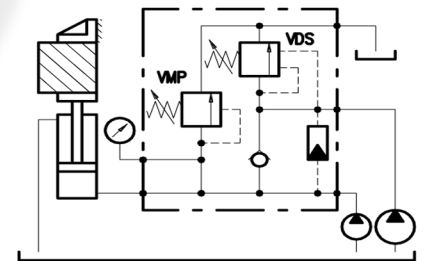
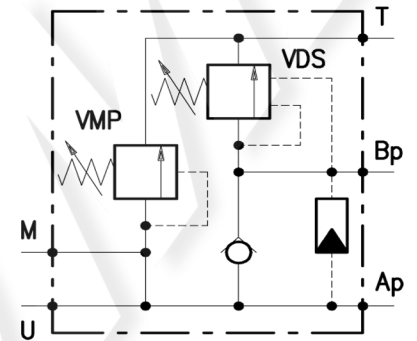

• DESCRIPTION

High/Low pressure cut-out valve.

• OPERATION

Recommended for systems powered by two pumps where double speed (fast-slow sequence) is made available. Fast speed is obtained by summing up both pumps capacity up to the setting value of the VDS valve. Slow speed according to the small pump is obtained by later discharge of the bigger pump. Working pressure during slow speed is controlled by the VMP valve.

• PERFORMANCE

Maximum flow:

- Ap line = 80 l/min.
- Bp line = 200 l/min.
- U line = 250 l/min.

Maximum Pressure:

- 210 bar (aluminium body)
- 350 bar (steel body)

Application range with standard springs "Ap"(VMP):

- 50 ÷ 220 bar (test setting: 180 bar at 5 l/min.)
- 180 ÷ 350 bar (test setting: 280 bar at 5 l/min.)

To perform setting of the valve see the pressure drop / flow diagram.

Application range with standard springs "Bp"(VDS):

- 5 ÷ 40 bar (test setting: 30 bar at 5 l/min.)
- 20 ÷ 80 bar (test setting: 60 bar at 5 l/min.)

Working temperature:

- min. -25°C max. 90°C with standard BUNA N gaskets

• RECOMMENDATIONS:

Fluid: best use mineral oil with viscosity ranging between 10 and 200 cSt.

Filter: see page Z.9000.000.

Weight:

- 8.40 kg (aluminium body)

- 19.50 kg (steel body)

Material: internal components made out of high-grade steel duly treated and fabricated.

For more information please ask our technical office .

Variations and modifications of technical features and dimensions are reserved. **OLEOSTAR S.p.A.** also reserves the right to stop production of each and any model listed in the catalogue with no notice.

Copyrights on the text contained herein belong to **OLEOSTAR S.p.A.** . Partial and full reproductions or copies of this catalogue are forbidden.

• RATING DIAGRAMS

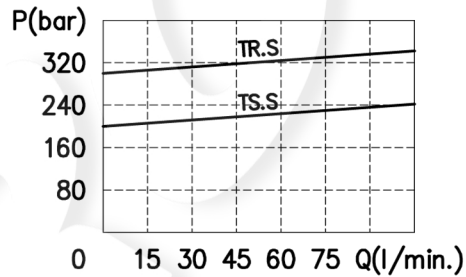
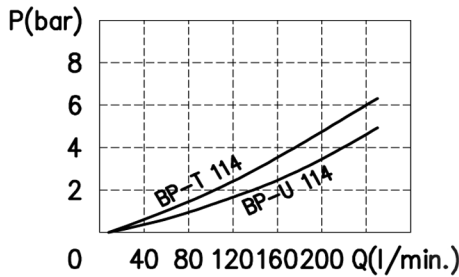

Oil viscosity 46 cSt

• ADJUSTMENTS

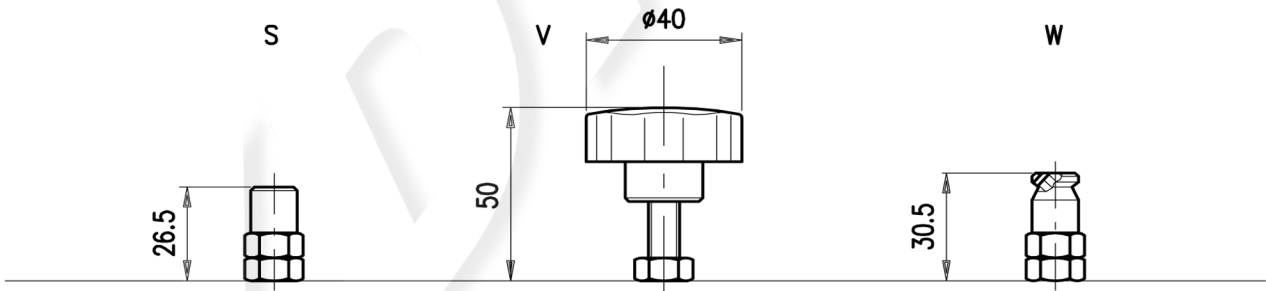

• CODE NUMBER

