

Part number:

HYDROMA

HYDRAULICKÉ SYSTÉMY

**HIDROMA
SYSTEMS**

UKŁADY HYDRAULICZNE

HYDROMA

ГИДРАВЛИЧЕСКИЕ СИСТЕМЫ

FRD-MRH

RETURN FILTERS

MATERIALS

Cover & housing: Anodized aluminium alloy

For 61&62 only:

Cover: anodized aluminium alloy

Housing: steel

Bypass valve: Steel

Seals: NBR Nitrile (FKM - on request fluoroelastomer)

Indicator housing: Brass

PRESSURE

Max. working: 2 MPa (20 bar)

Collapse, differential for the filter element (ISO 2941):

1 MPa (10 bar)

BYPASS VALVE

Setting: 300 kPa (3 bar) \pm 10%

WORKING TEMPERATURE

From -25° to +110° C

COMPATIBILITY (ISO 2943)

Full with fluids: HH-HL-HM-HV-HTG

(according to ISO 6743/4)

For fluids different than the above mentioned,
please contact our Customer Service.

HYDRAULIC DIAGRAM

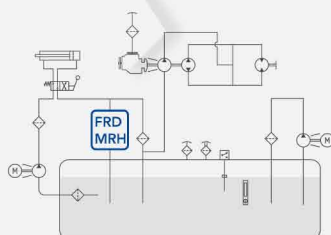

Is this datasheet the latest release? Please check on our website.

FRD

RETURN FILTERS

ORDERING AND OPTION CHART

| F | R | D | COMPLETE FILTER FAMILY | | | | | | | | | FILTER ELEMENT FAMILY | E | R | D | |
|---|---|---|--|----|----|----|----|----|----|----|---------------|-----------------------|---|---|---|--|
| | | | SIZE & LENGTH | 11 | 21 | 31 | 41 | 51 | 61 | 62 | SIZE & LENGTH | | | | | |
| | | | PORT TYPE | | | | | | | | | | | | | |
| | | | B = BSP thread | B | B | B | B | B | - | - | | | | | | |
| | | | N = NPT thread | N | N | N | N | N | - | - | | | | | | |
| | | | S = SAE thread | S | S | S | S | S | - | - | | | | | | |
| | | | F = SAE flange 3000 psi,metric screw | - | - | F | F | F | F | F | | | | | | |
| | | | PORT SIZE | | | | | | | | | | | | | |
| | | | 04 = 1/2" | 04 | - | - | - | - | - | - | | | | | | |
| | | | 06 = 3/4" | - | 06 | - | - | - | - | - | | | | | | |
| | | | 08 = 1" | - | - | 08 | - | - | - | - | | | | | | |
| | | | 12 = 1" 1/2 | - | - | - | 12 | - | - | - | | | | | | |
| | | | 20 = 2" 1/2 | - | - | - | - | 20 | - | - | | | | | | |
| | | | 28 = 3" 1/2 | - | - | - | - | - | 28 | - | | | | | | |
| | | | 32 = 4" | - | - | - | - | - | - | 32 | | | | | | |
| | | | BYPASS VALVE | | | | | | | | | | | | | |
| | | | W = without | W | W | W | W | W | W | W | W | | | | | |
| | | | D = 300 kPa (3 bar) | D | D | D | D | D | D | D | | | | | | |
| | | | SEALS | | | | | | | | | | | | | |
| | | | N = NBR Nitrile | N | N | N | N | N | N | N | N | | | | | |
| | | | F = FKM Fluoroelastomer | F | F | F | F | F | F | F | F | | | | | |
| | | | FILTER MEDIA | | | | | | | | | | | | | |
| | | | FA = fibreglass 5 µm(c) β>1.000 | FA | FA | FA | FA | FA | FA | FA | FA | | | | | |
| | | | FB = fibreglass 7 µm(c) β>1.000 | FB | FB | FB | FB | FB | FB | FB | FB | | | | | |
| | | | FC = fibreglass 12 µm(c) β>1.000 | FC | FC | FC | FC | FC | FC | FC | FC | | | | | |
| | | | FD = fibreglass 21 µm(c) β>1.000 | FD | FD | FD | FD | FD | FD | FD | FD | | | | | |
| | | | CC = impregnated cellulose 10 µm β>2 | CC | CC | CC | CC | CC | CC | CC | CC | | | | | |
| | | | CD = impregnated cellulose 25 µm β>2 | CD | CD | CD | CD | CD | CD | CD | CD | | | | | |
| | | | MD = wire mesh 30 µm | MD | MD | MD | MD | MD | MD | MD | MD | | | | | |
| | | | ME = wire mesh 60 µm | ME | ME | ME | ME | ME | ME | ME | ME | | | | | |
| | | | WR = water removal * | - | - | WR | WR | WR | WR | WR | WR | | | | | |
| | | | CLOGGING INDICATOR** | | | | | | | | | | | | | |
| | | | 03 = port, plugged | 03 | 03 | 03 | 03 | 03 | 03 | 03 | 03 | | | | | |
| | | | 5C = visual differential 200 kPa (2 bar) | 5C | 5C | 5C | 5C | 5C | 5C | 5C | 5C | | | | | |
| | | | 6C = electrical differential 200 kPa (2 bar) | 6C | 6C | 6C | 6C | 6C | 6C | 6C | 6C | | | | | |
| | | | 7C = indicator 6C with LED | 7C | 7C | 7C | 7C | 7C | 7C | 7C | 7C | | | | | |
| | | | T1 = elect. diff. 200 kPa (2 bar) with thermostat 30°C | T1 | T1 | T1 | T1 | T1 | T1 | T1 | T1 | | | | | |
| X | X | | ACCESSORIES | | | | | | | | | | | | | |
| | | | XX= no other accessory available | XX | XX | XX | XX | XX | XX | XX | XX | | | | | |

MRH

RETURN FILTERS

ORDERING AND OPTION CHART

| M | R | H | COMPLETE FILTER FAMILY | | | | | | | | FILTER ELEMENT FAMILY | C | R | H |
|---|---|---|--|-----|-----|-----|-----|-----|-----|--|-----------------------|---|---|---|
| | | | SIZE & LENGTH | 008 | 015 | 025 | 070 | 150 | 250 | | SIZE & LENGTH | | | |
| | | | FILTER MEDIA | | | | | | | | FILTER MEDIA | | | |
| | | | FT = fibreglass 5 µm(c) β>1.000 | FT | FT | FT | FT | FT | FT | | | | | |
| | | | FC = fibreglass 7 µm(c) β>1.000 | FC | FC | FC | FC | FC | FC | | | | | |
| | | | FD = fibreglass 12 µm(c) β>1.000 | FD | FD | FD | FD | FD | FD | | | | | |
| | | | FV = fibreglass 21 µm(c) β>1.000 | FV | FV | FV | FV | FV | FV | | | | | |
| | | | CD = impregnated cellulose 10 µm β>2 | CD | CD | CD | CD | CD | CD | | | | | |
| | | | CV = impregnated cellulose 25 µm β>2 | CV | CV | CV | CV | CV | CV | | | | | |
| | | | MV = wire mesh 30 µm | MV | MV | MV | MV | MV | MV | | | | | |
| | | | MS = wire mesh 60 µm | MS | MS | MS | MS | MS | MS | | | | | |
| | | | WR = water removal * | WR | WR | WR | WR | WR | WR | | | | | |
| | | | SEALS | | | | | | | | SEALS | | | |
| | | | 1 = NBR Nitrile | 1 | 1 | 1 | 1 | 1 | 1 | | | | | |
| | | | 2 = FKM Fluoroelastomer | 2 | 2 | 2 | 2 | 2 | 2 | | | | | |
| | | | BYPASS VALVE | | | | | | | | | | | |
| | | | S = without | S | S | S | S | S | S | | | | | |
| | | | D = 300 kPa (3 bar) | D | D | D | D | D | D | | | | | |
| | | | PORT TYPE | | | | | | | | | | | |
| | | | B = BSP thread | B | B | B | B | B | - | | | | | |
| | | | N = NPT thread | N | N | N | N | N | - | | | | | |
| | | | S = SAE thread | S | S | S | S | S | - | | | | | |
| | | | F = SAE flange 3000 psi,metric screw | - | - | F | F | F | F | | | | | |
| | | | PORT SIZE | | | | | | | | | | | |
| | | | 3 = 1/2" | 3 | - | - | - | - | - | | | | | |
| | | | 4= 3/4" | - | 4 | - | - | - | - | | | | | |
| | | | 5 = 1" | - | - | 5 | - | - | - | | | | | |
| | | | 7 = 1" 1/2 | - | - | - | 7 | - | - | | | | | |
| | | | 9 = 2" 1/2 | - | - | - | - | 9 | - | | | | | |
| | | | B = 3" 1/2 | - | - | - | - | - | B | | | | | |
| | | | CLOGGING INDICATOR** | | | | | | | | | | | |
| | | | 03 = port, plugged | 03 | 03 | 03 | 03 | 03 | 03 | | | | | |
| | | | 5C = visual differential 200 kPa (2 bar) | 5C | 5C | 5C | 5C | 5C | 5C | | | | | |
| | | | 6C = electrical differential 200 kPa (2 bar) | 6C | 6C | 6C | 6C | 6C | 6C | | | | | |
| | | | 7C = indicator 6C with LED | 7C | 7C | 7C | 7C | 7C | 7C | | | | | |
| | | | T1 = elect. diff. 200 kPa (2 bar) with thermostat 30°C | T1 | T1 | T1 | T1 | T1 | T1 | | | | | |
| X | X | | ACCESSORIES | | | | | | | | | | | |
| | | | XX= no other accessory available | XX | XX | XX | XX | XX | XX | | | | | |

NOTES

- * Water removal media - see "hydro dry" brochure
- ** When the filter is ordered with FKM seals, the first digit of the indicator code is a letter (please see Clogging Indicator Chapter for further details)

INSTALLATION DRAWING

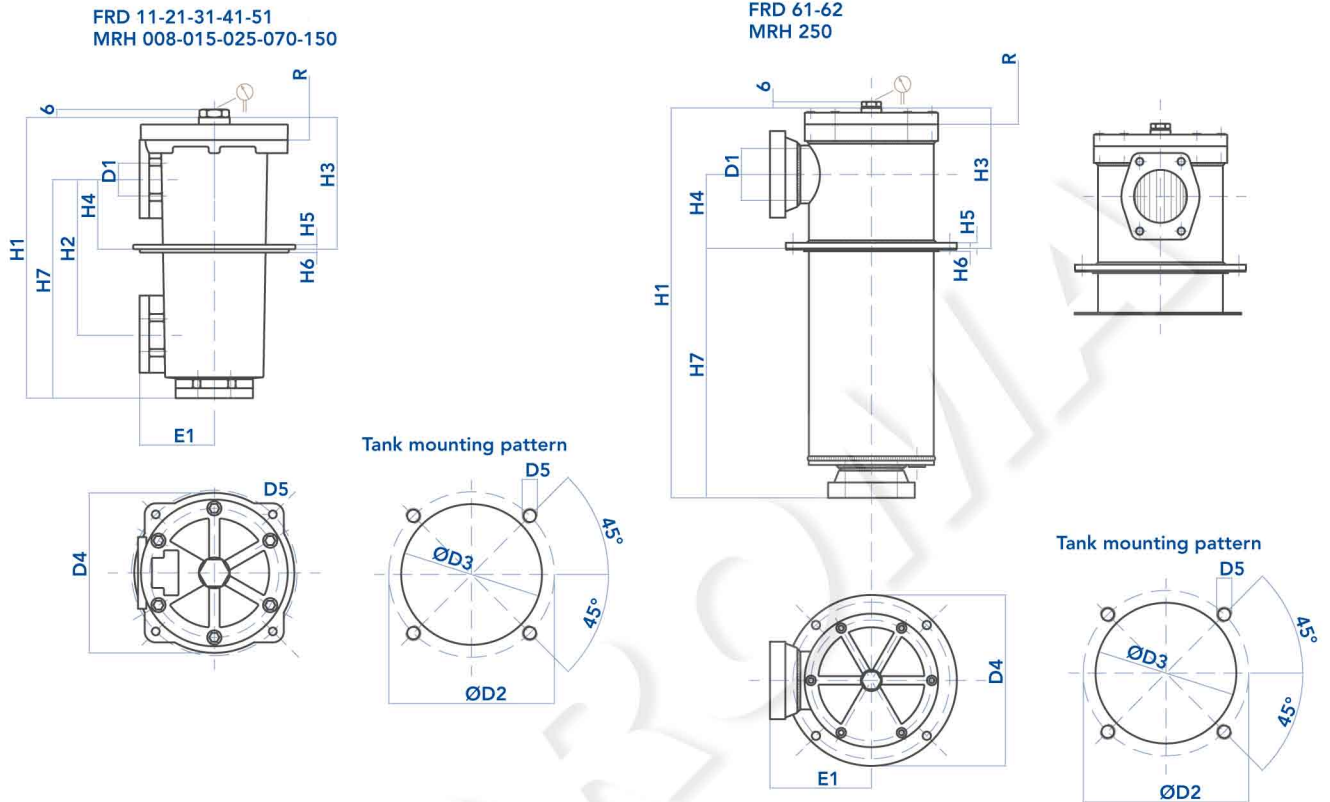

FILTER HOUSING

| | D1 | D2 | D3 | D4 | D5 | E1 | H1 | H2 | H3 | H4 | H5 | H6 | H7 | R | Kg |
|-----------------|-------|-----|-----|-----|-----|-------|-------|------|-----|------|----|----|-----|-------|------|
| FRD11 MRH008 | 1/2" | 95 | 85 | 90 | M5 | 43 | 160 | 62,5 | 96 | 31,5 | 4 | 3 | 96 | 105 | 1,30 |
| FRD21 MRH015 | 3/4" | 138 | 123 | 128 | M6 | 57 | 191 | 105 | 100 | 52 | 6 | 3 | 145 | 110 | 2,6 |
| FRD31 MRH025 | 1" | 154 | 137 | 147 | M6 | 67 | 250 | 140 | 117 | 63 | 8 | 4 | 197 | 155 | 3,7 |
| FRD41 MRH070 | 1"1/2 | 180 | 164 | 174 | M8 | 82 | 343 | 177 | 155 | 82 | 8 | 4 | 269 | 240 | 6,5 |
| FRD51 MRH150 | 2"1/2 | 275 | 239 | 254 | M10 | 117,5 | 420 | 218 | 192 | 91 | 10 | 8 | 320 | 275 | 14,2 |
| FRD61 MRH250 | 3"1/2 | 275 | 239 | 300 | M12 | 178 | 673 | - | 248 | 130 | 10 | 5 | - | 525 | 49,0 |
| FRD62 | 4" | 275 | 239 | 300 | M12 | 178 | 1.108 | - | 423 | 265 | 10 | 5 | 950 | 1.020 | 70,0 |

FRD-MRH

RETURN FILTERS

MAINTENANCE

The best time to change your filter element is just before it reaches its maximum dirt-holding capacity. For this reason, we recommend to monitor the pressure of the hydraulic oil flowing through the filter with a clogging indicator. When it is time to change the filter element, switch off the system.

Unscrew the cover and remove it. If the filter has a by-pass valve, don't touch it.

Remove the dirty filter element using the upper handle. Replace it with an original UFI element, verifying the part number on the filter label or on the catalogue. Lubricate the gaskets for an optimal assembly. Position the cover carefully to ensure the seal on the filter element. Tighten the screws with the washers until it stops.

We recommend the stocking of a spare UFI filter element for timely replacement when required.



FILTER ELEMENT

| | A | B | C | Kg | AREA (cm ²) | | |
|-----------------|-----|-------|-----|------|-------------------------|----------|----------|
| | | | | | Media F+ | Media C+ | Media M+ |
| ERD11 CRH008 | 52 | 28/24 | 70 | 0,10 | 310 | 380 | 245 |
| ERD21 CRH015 | 70 | 34 | 85 | 0,20 | 620 | 990 | 460 |
| ERD31 CRH025 | 70 | 34 | 130 | 0,25 | 1.000 | 1.600 | 740 |
| ERD41 CRH070 | 99 | 51 | 211 | 0,70 | 3.800 | 4.280 | 2.330 |
| ERD51 CRH150 | 130 | 74 | 251 | 1,50 | 7.930 | 8.350 | 3.340 |
| ERD61 CRH250 | 130 | 74/85 | 500 | 2,00 | 16.720 | 17.600 | 9.860 |
| ERD62 | 143 | 96,3 | 896 | 3,80 | 40.000 | 40.000 | 22.000 |

The used filter elements cannot be cleaned and are classified as "Dangerous waste material". They must be disposed according to local laws by authorized Companies.

Verify that the Company you choose has the expertise and authorization to dispose this type of waste material.

PRESSURE DROP CURVES (Δp)

The "Assembly Pressure Drop (Δp)" is obtained by adding the pressure drop values of the Filter Housing and of the Clean Filter Element corresponding to the considered Flow

Rate and it must be lower than 50 kPa (0,5 bar) and should never exceed 1/3 of the bypass valve setting.

FILTER HOUSING PRESSURE DROP
(mainly depending on the port size)

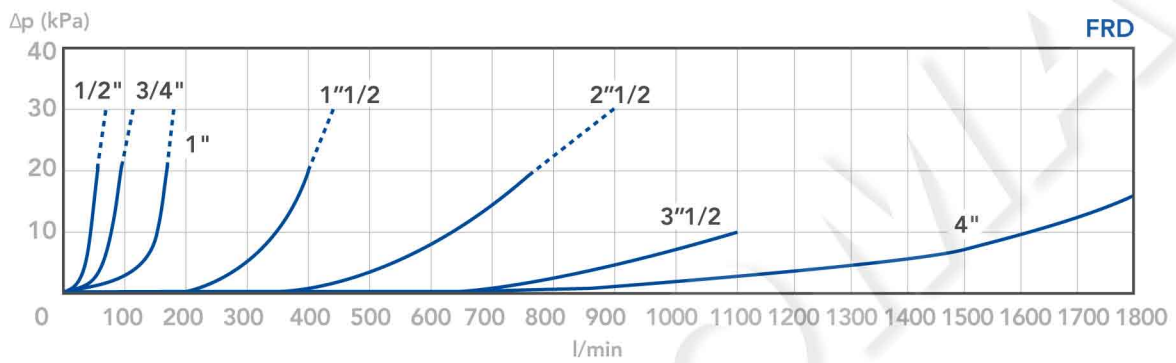

CLEAN FILTER ELEMENT PRESSURE DROP WITH F+, C+ AND M+ MEDIA
(depending both on the internal diameter of the element and on the filter media)

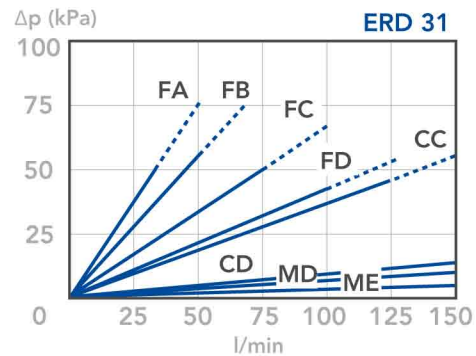
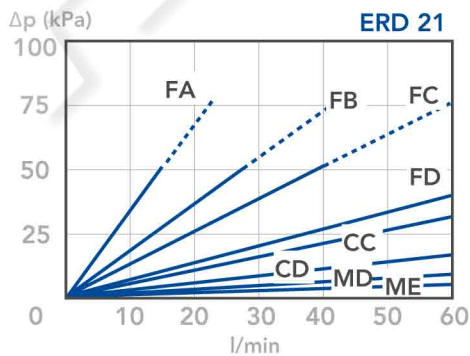
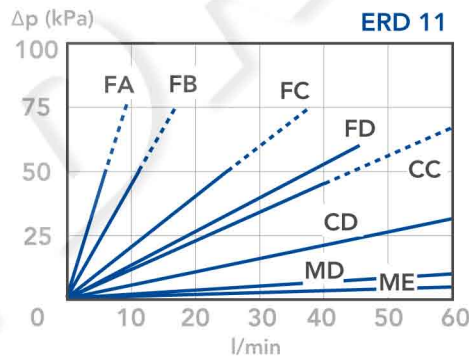

FRD-MRH

RETURN FILTERS

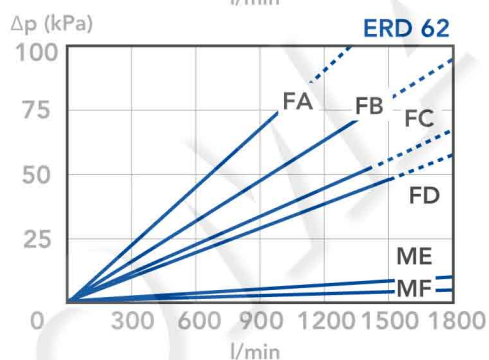
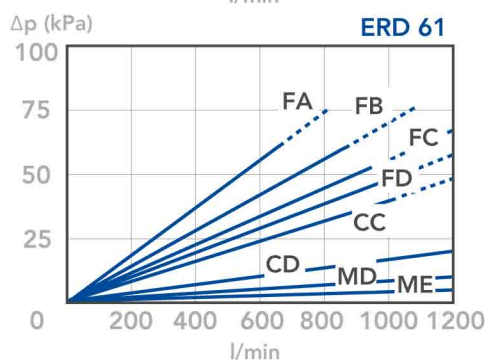
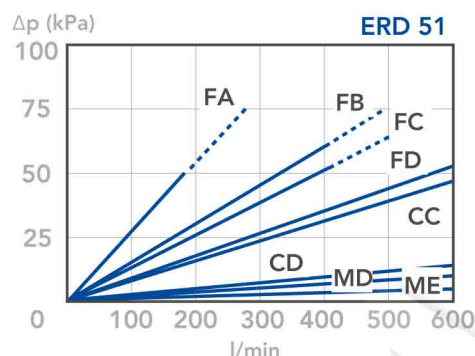
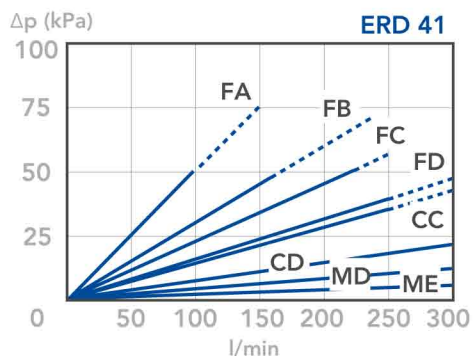

BYPASS VALVE PRESSURE DROP

When selecting the filter size, these curves must be taken into account if it is foreseen that any flow peak is to be absorbed by the bypass valve, it also must be of proper configuration to avoid pressure peaks. The valve pressure drop is directly proportional to fluid specific gravity.

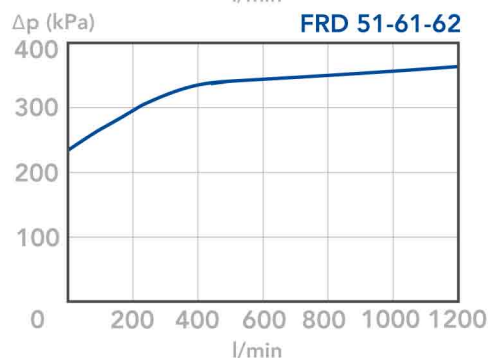
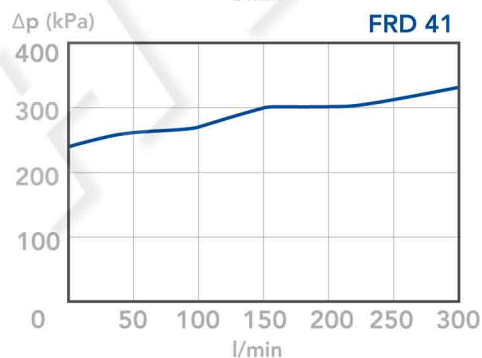
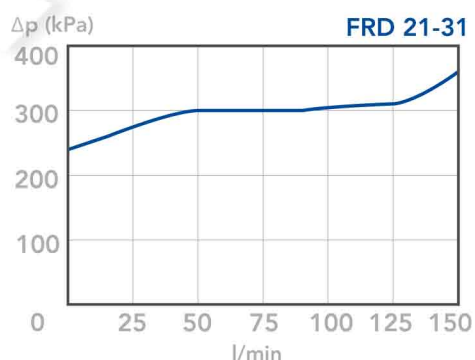
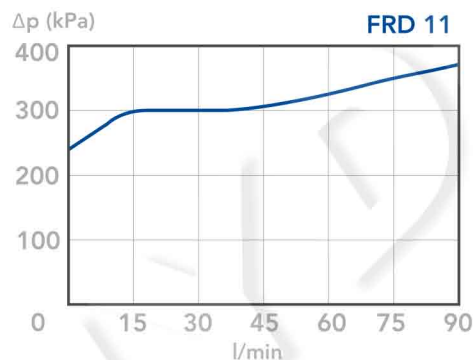

N.B.

All the curves have been obtained with mineral oil having a kinematic viscosity 30 cSt and specific gravity 0,86 Kg/dm³; for fluids with different features, please consider the factors described in the first part of this catalogue. All the curves

are obtained from test done at the UFI HYDRAULIC DIVISION Laboratory, according to the specification ISO 3968. In case of discrepancy, please check the contamination level, viscosity and features of the fluid in use.

RETURN FILTERS

CLOGGING INDICATORS

| INDICATOR SERIE | | DESCRIPTION | FOR RETURN FILTERS SERIES | |
|--|------------|---|---------------------------|--|
| NBR | FKM | Differential ELECTRICAL indicators with THERMOSTAT 30° C | | |
| T0 | DB | Setting 1,3 bar (130 kPa) | FRF RFC | |
| T1 | DC | Setting 2 bar (200 kPa) | FRD MRH | |
| <p>SPDT differential switch. C.C. 14 - 30 V: > max resistive or inductive load 4 - 3 A respectively C.A. 125-250 V: > max resistive or inductive load 1 A - Protection IP65 - Connector DIN 43650</p> | | | | |
| NBR | FKM | Differential VISUAL ELECTRICAL indicators | | |
| 70 | E0 | Setting 1,3 bar (130 kPa) | FRF RFC | |
| 71 | E1 | Setting 2 bar (200 kPa) | FRD MRH | |
| <p>SPDT differential switch. C.C. 14 - 30 V: > max resistive or inductive load 4 - 3 A respectively C.A. 125-250 V: > max resistive or inductive load 1 A - Protection IP65 - Connector DIN 43650</p> | | | | |
| NBR | FKM | Differential ELECTRICAL indicators ATEX | | |
| 008.0239.2 | - | Setting 1,3 bar (130 kPa) | FRF RFC | |
| 008.0234.2 | - | Setting 2 bar (200 kPa) | FRD MRH | |
| <p>SPDT differential switch. C.C. 14 - 30 V: > max resistive or inductive load 4 - 3 A respectively C.A. 125-250 V: > max resistive or inductive load 1 A - Protection IP65 - Connector DIN 43650</p> | | | | |