

Part number:

086-10069

HYDROMA

HYDRAULICKÉ SYSTÉMY

**HIDROMA
SYSTEMS**

UKŁADY HYDRAULICZNE

HYDROMA

ГИДРАВЛИЧЕСКИЕ СИСТЕМЫ

FFS: Flange per il fissaggio sul serbatoio di tubazioni in aspirazione o sul ritorno

FFS series: Oiltank fixing flanges for inlet or outlet tubes

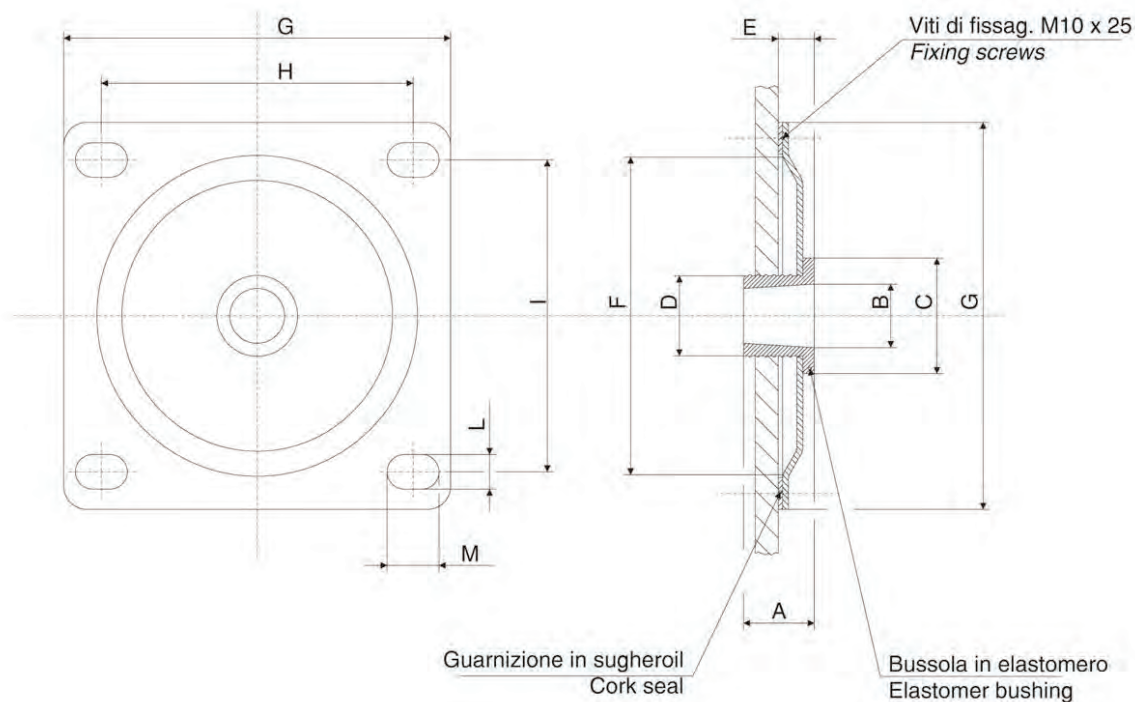

Le flange di tipo "FFS" permettono il fissaggio sul serbatoio di tubazioni in aspirazione o sul ritorno e la manutenzione o il semplice controllo dei filtri immersi nel serbatoio.

Flanges of the series "FFS" allow the fixing on the oiltank of inlet and outlet tubes and the maintenance or simply the check of the semi-immersed filters into the oiltank.

Cod. flangia completa Complete flange part number	Bussole in elastomero Elastomer bushings	A	øB	øC	øD	E	øF	G	H	I	L	M
FFS 15	BPT-15	24	15	40	28	12.5	110	134	108	108	12	18
FFS 18	BPT-18	24	18	40	28	12.5	110	134	108	108	12	18
FFS 22	BPT-22	24	22	40	28	12.5	110	134	108	108	12	18
FFS 28	BPT-28	24	28	55	42	12.5	110	134	108	108	12	18
FFS 35	BPT-35	24	35	55	42	12.5	110	134	108	108	12	18
FFS 44	BPT-44	24	44	70	58	12.5	110	134	108	108	12	18
FFS 45	BPT-44	24	44	70	58	12.5	164	190	159	159	12	18
FFS 50	BPT-50	24	50	70	58	12.5	164	190	159	159	12	18
FFS 61	BPT-61	24	61	80	68	12.5	164	190	159	159	12	18
FFS 77	BPT-77	24	77	110	95	12.5	164	190	159	159	12	18
FFS 89	BPT-89	24	89	110	95	12.5	164	190	159	159	12	18