

Part number:

HYDROMA

HYDRAULICKÉ SYSTÉMY

**HIDROMA
SYSTEMS**

UKŁADY HYDRAULICZNE

HYDROMA

ГИДРАВЛИЧЕСКИЕ СИСТЕМЫ

T-304A

Code **304**



(0.01)



kg	[kg]	19	l	1.1
----	------	----	---	-----

Per configurazioni non a catalogo contattare Servizio Tecnico-Commerciale
For non-catalog configurations contact Technical-Commercial Service

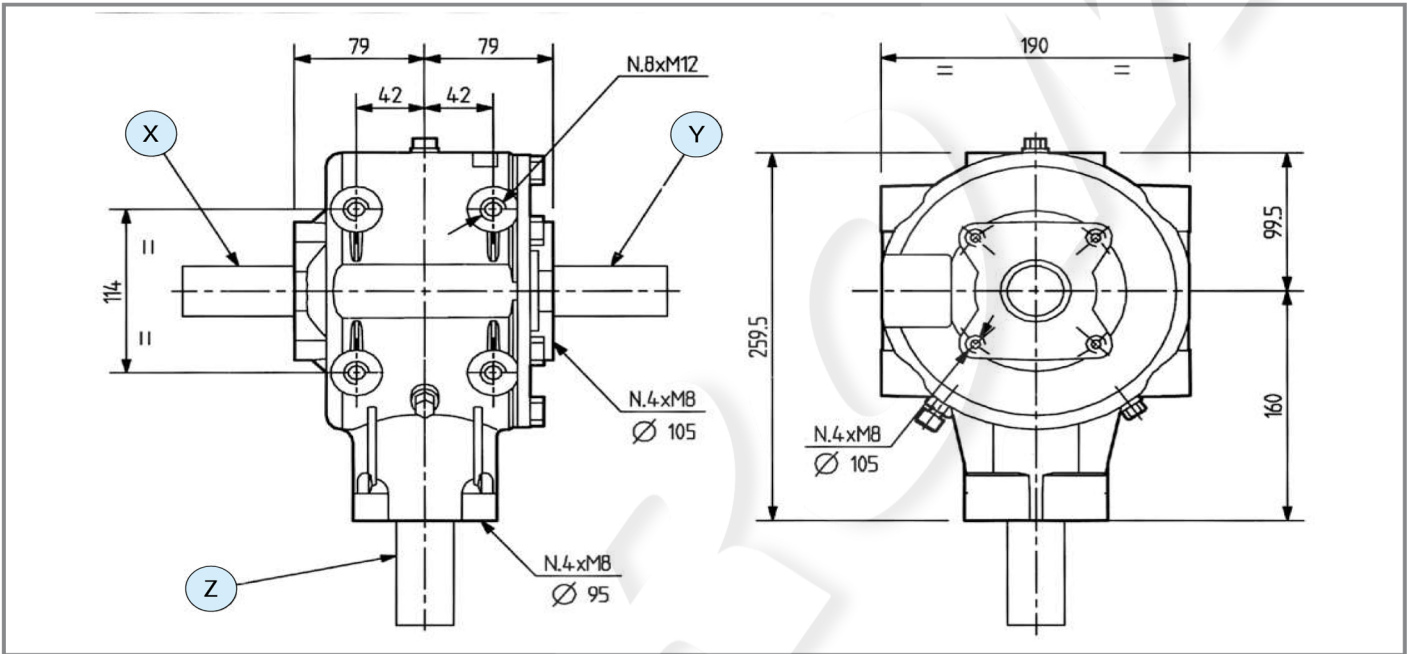



3 - Dentatura elicoidale / Helical Teeth

	i	N ₁ [rpm]	P ₁ [kW]	M ₂ [Nm]	Shaft type			Input	Option	Code	Mounting	
					X	Y	Z					
M →	4.50	540	28.0	107				Y	3	9.304.019		special
	3.00	540	36.9	211				X	-	9.304.000		std
	3.00	540	36.9	211		-		X	-	9.304.010		std
	3.00	540	36.9	211		-		X	-	9.304.013		std
	1.93	540	40.4	359				X	-	9.304.006		std
	1.93	540	40.4	359		-		X	-	9.304.015		std
	1.93	540	40.4	359		-		Y	-	9.304.014		std
R →	1.93	540	27.9	924				Z	-	9.304.006		std
	1.93	540	27.9	924		-		Z	-	9.304.015		std
	1.93	540	27.9	924		-		Z	-	9.304.014		std

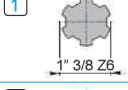
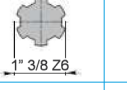
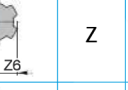
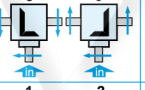
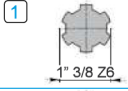
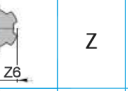
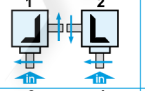
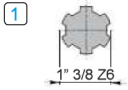
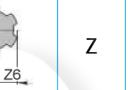
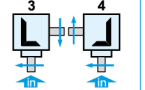
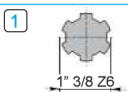
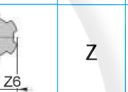
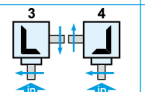
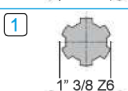
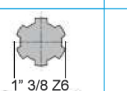

3 - Dentatura elicoidale / Helical Teeth

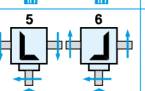
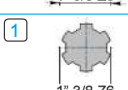
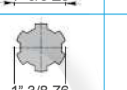
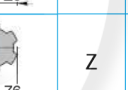
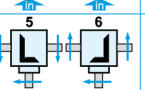
	i	N ₁ [rpm]	P ₁ [kW]	M ₂ [Nm]	Shaft type			Input	Option	Code	Mounting	
					X	Y	Z					
R → + →	3.00	540	18.4	947				Z	-	9.304.000		std
	3.00	540	18.4	947		-		Z	-	9.304.010		std
	3.00	540	18.4	947		-		Z	-	9.304.013		std
	4.50	540	11.0	849		-		Z	3	9.304.018		special
	4.50	540	11.0	849				Z	3	9.304.019		special
	5.33	540	9.9	906				Z	3	9.304.025		special