

Part number:

HYDROMA
HYDRAULICKÉ SYSTÉMY

HIDROMA
SYSTEMS
UKŁADY HYDRAULICZNE

HYDROMA
ГИДРАВЛИЧЕСКИЕ СИСТЕМЫ

FRD-MRH

RETURN FILTERS

MATERIALS

Cover & housing: Anodized aluminium alloy

For 61&62 only:

Cover: anodized aluminium alloy

Housing: steel

Bypass valve: Steel

Seals: NBR Nitrile (FKM - on request fluoroelastomer)

Indicator housing: Brass

PRESSURE

Max. working: 2 MPa (20 bar)

Collapse, differential for the filter element (ISO 2941):

1 MPa (10 bar)

BYPASS VALVE

Setting: 300 kPa (3 bar) \pm 10%

WORKING TEMPERATURE

From -25° to +110° C

COMPATIBILITY (ISO 2943)

Full with fluids: HH-HL-HM-HV-HTG

(according to ISO 6743/4)

For fluids different than the above mentioned,
please contact our Customer Service.

HYDRAULIC DIAGRAM

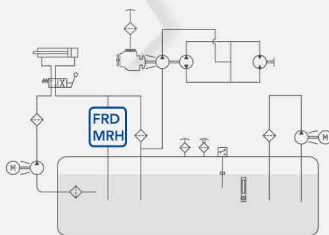

Is this datasheet the latest release? Please check on our website.

FRD

RETURN FILTERS

ORDERING AND OPTION CHART

F	R	D	COMPLETE FILTER FAMILY									FILTER ELEMENT FAMILY	E	R	D	
			SIZE & LENGTH	11	21	31	41	51	61	62	SIZE & LENGTH					
			PORT TYPE													
			B = BSP thread	B	B	B	B	B	-	-						
			N = NPT thread	N	N	N	N	N	-	-						
			S = SAE thread	S	S	S	S	S	-	-						
			F = SAE flange 3000 psi,metric screw	-	-	F	F	F	F	F						
			PORT SIZE													
			04 = 1/2"	04	-	-	-	-	-	-						
			06 = 3/4"	-	06	-	-	-	-	-						
			08 = 1"	-	-	08	-	-	-	-						
			12 = 1" 1/2	-	-	-	12	-	-	-						
			20 = 2" 1/2	-	-	-	-	20	-	-						
			28 = 3" 1/2	-	-	-	-	-	28	-						
			32 = 4"	-	-	-	-	-	-	32						
			BYPASS VALVE													
			W = without	W	W	W	W	W	W	W	W					
			D = 300 kPa (3 bar)	D	D	D	D	D	D	D						
			SEALS													
			N = NBR Nitrile	N	N	N	N	N	N	N	N					
			F = FKM Fluoroelastomer	F	F	F	F	F	F	F	F					
			FILTER MEDIA													
			FA = fibreglass 5 µm(c) β>1.000	FA	FA	FA	FA	FA	FA	FA	FA					
			FB = fibreglass 7 µm(c) β>1.000	FB	FB	FB	FB	FB	FB	FB	FB					
			FC = fibreglass 12 µm(c) β>1.000	FC	FC	FC	FC	FC	FC	FC	FC					
			FD = fibreglass 21 µm(c) β>1.000	FD	FD	FD	FD	FD	FD	FD	FD					
			CC = impregnated cellulose 10 µm β>2	CC	CC	CC	CC	CC	CC	CC	CC					
			CD = impregnated cellulose 25 µm β>2	CD	CD	CD	CD	CD	CD	CD	CD					
			MD = wire mesh 30 µm	MD	MD	MD	MD	MD	MD	MD	MD					
			ME = wire mesh 60 µm	ME	ME	ME	ME	ME	ME	ME	ME					
			WR = water removal *	-	-	WR	WR	WR	WR	WR	WR					
			CLOGGING INDICATOR**													
			03 = port, plugged	03	03	03	03	03	03	03	03					
			5C = visual differential 200 kPa (2 bar)	5C	5C	5C	5C	5C	5C	5C	5C					
			6C = electrical differential 200 kPa (2 bar)	6C	6C	6C	6C	6C	6C	6C	6C					
			7C = indicator 6C with LED	7C	7C	7C	7C	7C	7C	7C	7C					
			T1 = elect. diff. 200 kPa (2 bar) with thermostat 30°C	T1	T1	T1	T1	T1	T1	T1	T1					
X	X		ACCESSORIES													
			XX= no other accessory available	XX	XX	XX	XX	XX	XX	XX	XX					

MRH

RETURN FILTERS

ORDERING AND OPTION CHART

M	R	H	COMPLETE FILTER FAMILY								FILTER ELEMENT FAMILY	C	R	H
			SIZE & LENGTH	008	015	025	070	150	250		SIZE & LENGTH			
			FILTER MEDIA								FILTER MEDIA			
			FT = fibreglass 5 µm(c) β>1.000	FT	FT	FT	FT	FT	FT					
			FC = fibreglass 7 µm(c) β>1.000	FC	FC	FC	FC	FC	FC					
			FD = fibreglass 12 µm(c) β>1.000	FD	FD	FD	FD	FD	FD					
			FV = fibreglass 21 µm(c) β>1.000	FV	FV	FV	FV	FV	FV					
			CD = impregnated cellulose 10 µm β>2	CD	CD	CD	CD	CD	CD					
			CV = impregnated cellulose 25 µm β>2	CV	CV	CV	CV	CV	CV					
			MV = wire mesh 30 µm	MV	MV	MV	MV	MV	MV					
			MS = wire mesh 60 µm	MS	MS	MS	MS	MS	MS					
			WR = water removal *	WR	WR	WR	WR	WR	WR					
			SEALS								SEALS			
			1 = NBR Nitrile	1	1	1	1	1	1					
			2 = FKM Fluoroelastomer	2	2	2	2	2	2					
			BYPASS VALVE											
			S = without	S	S	S	S	S	S					
			D = 300 kPa (3 bar)	D	D	D	D	D	D					
			PORT TYPE											
			B = BSP thread	B	B	B	B	B	-					
			N = NPT thread	N	N	N	N	N	-					
			S = SAE thread	S	S	S	S	S	-					
			F = SAE flange 3000 psi,metric screw	-	-	F	F	F	F					
			PORT SIZE											
			3 = 1/2"	3	-	-	-	-	-					
			4= 3/4"	-	4	-	-	-	-					
			5 = 1"	-	-	5	-	-	-					
			7 = 1" 1/2	-	-	-	7	-	-					
			9 = 2" 1/2	-	-	-	-	9	-					
			B = 3" 1/2	-	-	-	-	-	B					
			CLOGGING INDICATOR**											
			03 = port, plugged	03	03	03	03	03	03					
			5C = visual differential 200 kPa (2 bar)	5C	5C	5C	5C	5C	5C					
			6C = electrical differential 200 kPa (2 bar)	6C	6C	6C	6C	6C	6C					
			7C = indicator 6C with LED	7C	7C	7C	7C	7C	7C					
			T1 = elect. diff. 200 kPa (2 bar) with thermostat 30°C	T1	T1	T1	T1	T1	T1					
X	X		ACCESSORIES											
			XX= no other accessory available	XX	XX	XX	XX	XX	XX					

NOTES

- * Water removal media - see "hydro dry" brochure
- ** When the filter is ordered with FKM seals, the first digit of the indicator code is a letter (please see Clogging Indicator Chapter for further details)

FRD-MRH

RETURN FILTERS

SPARE PARTS ELEMENTS

FILTER HOUSING	FILTER ELEMENT	CLOGGING INDICATOR																										
																												
<table border="1"> <tr> <td>B</td><td>R</td><td>D</td><td></td><td></td><td></td><td></td><td></td><td></td><td></td><td></td><td></td><td>X</td><td>X</td> </tr> </table>	B	R	D										X	X	<table border="1"> <tr> <td>E</td><td>R</td><td>D</td><td></td><td></td><td></td><td></td><td></td><td></td><td></td> </tr> </table>	E	R	D								<table border="1"> <tr> <td></td><td></td> </tr> </table>		
B	R	D										X	X															
E	R	D																										

SPARE SEAL KIT

	NBR	FKM
FRD11 MRH008	521.0045.2	521.0050.2
FRD21 MRH015	521.0046.2	521.0051.2
FRD31 MRH025	521.0047.2	521.0052.2
FRD41 MRH070	521.0031.2	521.0019.2
FRD51 MRH150	521.0048.2	521.0053.2
FRD61 MRH250	521.0049.2	521.0054.2
FRD62	521.0049.2	521.0094.2

INSTALLATION DRAWING

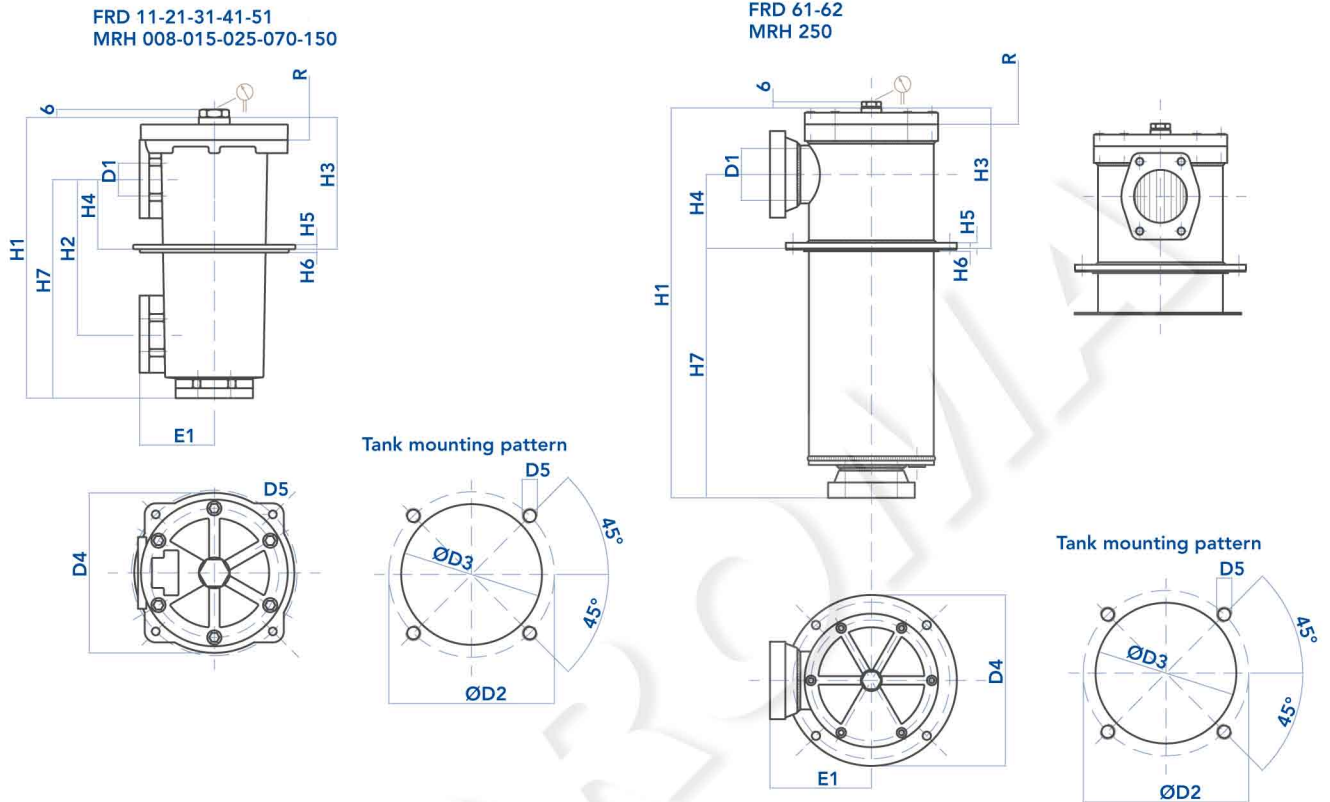

FILTER HOUSING

	D1	D2	D3	D4	D5	E1	H1	H2	H3	H4	H5	H6	H7	R	Kg
FRD11 MRH008	1/2"	95	85	90	M5	43	160	62,5	96	31,5	4	3	96	105	1,30
FRD21 MRH015	3/4"	138	123	128	M6	57	191	105	100	52	6	3	145	110	2,6
FRD31 MRH025	1"	154	137	147	M6	67	250	140	117	63	8	4	197	155	3,7
FRD41 MRH070	1"1/2	180	164	174	M8	82	343	177	155	82	8	4	269	240	6,5
FRD51 MRH150	2"1/2	275	239	254	M10	117,5	420	218	192	91	10	8	320	275	14,2
FRD61 MRH250	3"1/2	275	239	300	M12	178	673	-	248	130	10	5	-	525	49,0
FRD62	4"	275	239	300	M12	178	1.108	-	423	265	10	5	950	1.020	70,0

FRD-MRH

RETURN FILTERS

MAINTENANCE

The best time to change your filter element is just before it reaches its maximum dirt-holding capacity. For this reason, we recommend to monitor the pressure of the hydraulic oil flowing through the filter with a clogging indicator. When it is time to change the filter element, switch off the system.

Unscrew the cover and remove it. If the filter has a by-pass valve, don't touch it.

Remove the dirty filter element using the upper handle. Replace it with an original UFI element, verifying the part number on the filter label or on the catalogue. Lubricate the gaskets for an optimal assembly. Position the cover carefully to ensure the seal on the filter element. Tighten the screws with the washers until it stops.

We recommend the stocking of a spare UFI filter element for timely replacement when required.



FILTER ELEMENT

	A	B	C	Kg	AREA (cm ²)		
					Media F+	Media C+	Media M+
ERD11 CRH008	52	28/24	70	0,10	310	380	245
ERD21 CRH015	70	34	85	0,20	620	990	460
ERD31 CRH025	70	34	130	0,25	1.000	1.600	740
ERD41 CRH070	99	51	211	0,70	3.800	4.280	2.330
ERD51 CRH150	130	74	251	1,50	7.930	8.350	3.340
ERD61 CRH250	130	74/85	500	2,00	16.720	17.600	9.860
ERD62	143	96,3	896	3,80	40.000	40.000	22.000

The used filter elements cannot be cleaned and are classified as "Dangerous waste material". They must be disposed according to local laws by authorized Companies.

Verify that the Company you choose has the expertise and authorization to dispose this type of waste material.

PRESSURE DROP CURVES (ΔP)

The "Assembly Pressure Drop (Δp)" is obtained by adding the pressure drop values of the Filter Housing and of the Clean Filter Element corresponding to the considered Flow

Rate and it must be lower than 50 kPa (0,5 bar) and should never exceed 1/3 of the bypass valve setting.

FILTER HOUSING PRESSURE DROP
(mainly depending on the port size)

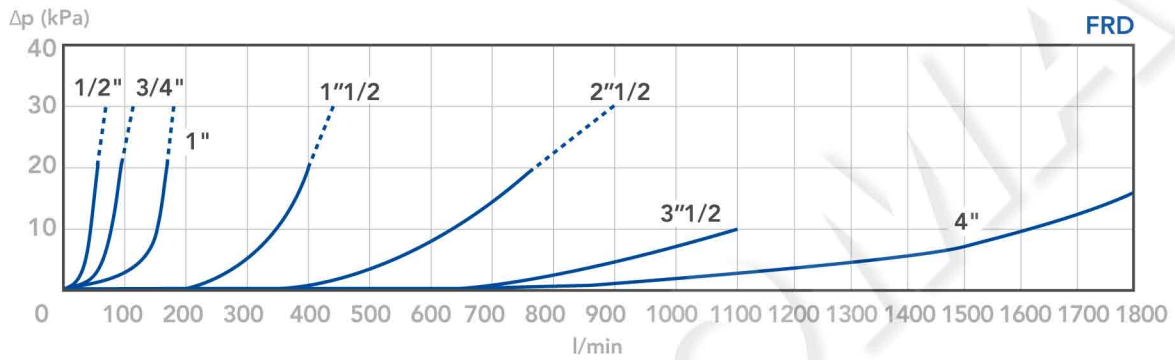

CLEAN FILTER ELEMENT PRESSURE DROP WITH F+, C+ AND M+ MEDIA
(depending both on the internal diameter of the element and on the filter media)

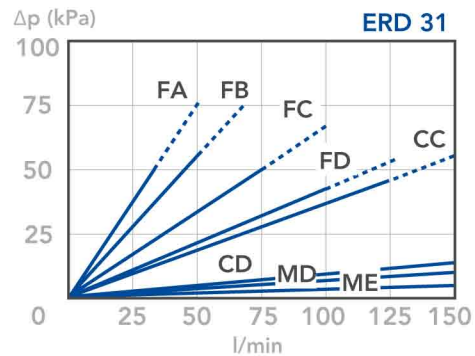
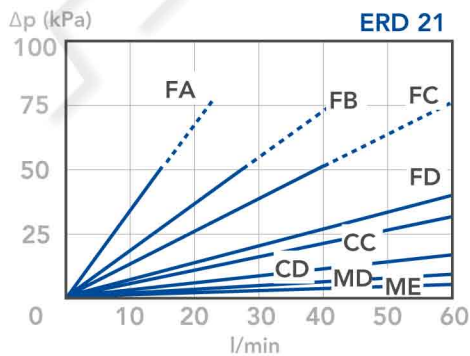
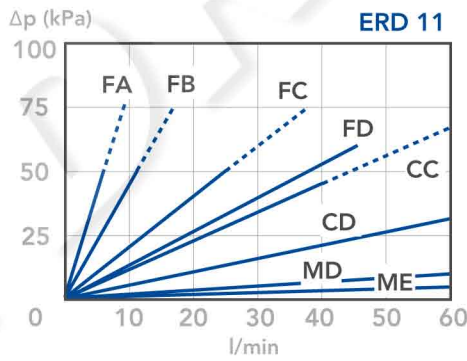

FRD-MRH

RETURN FILTERS

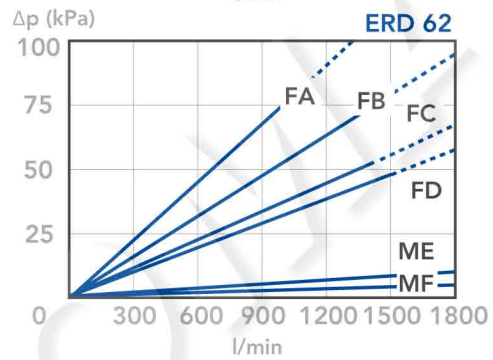
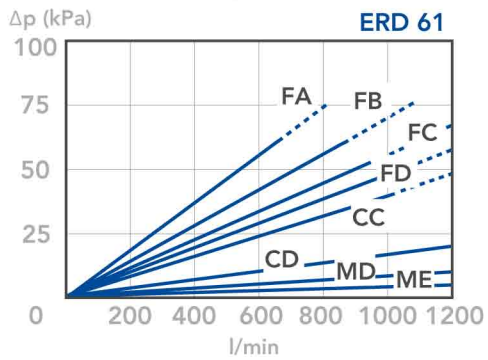
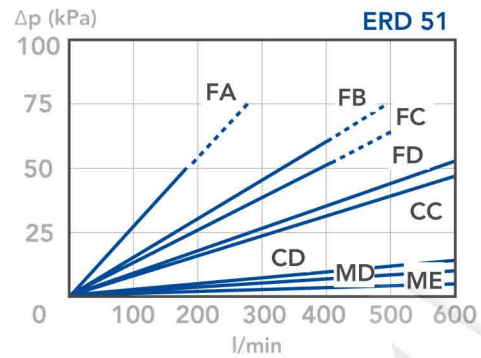
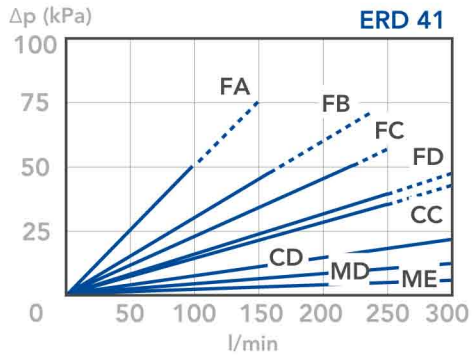

BYPASS VALVE PRESSURE DROP

When selecting the filter size, these curves must be taken into account if it is foreseen that any flow peak is to be absorbed by the bypass valve, it also must be of proper configuration to avoid pressure peaks. The valve pressure drop is directly proportional to fluid specific gravity.

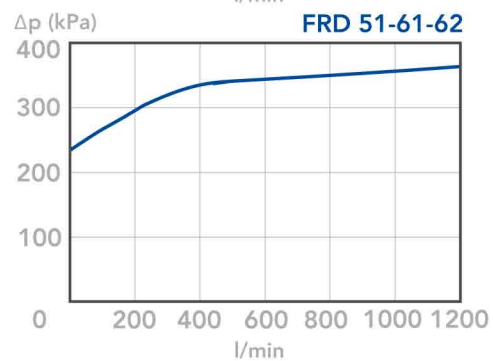
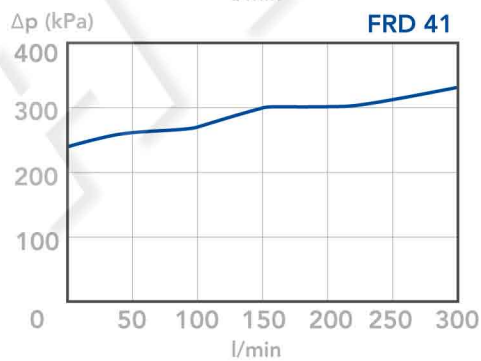
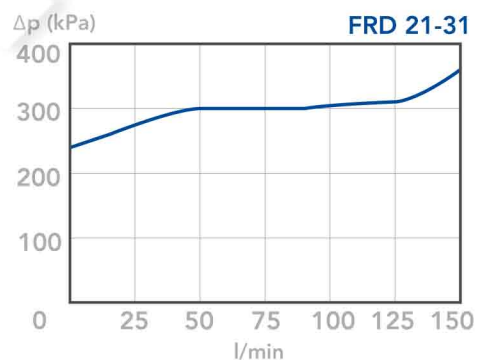
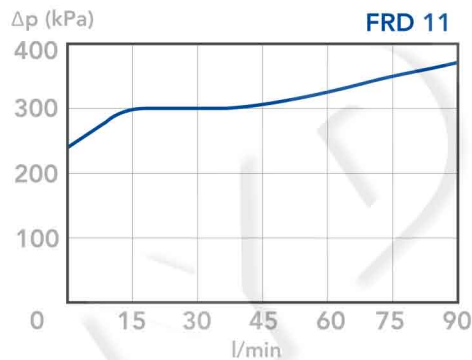

N.B.

All the curves have been obtained with mineral oil having a kinematic viscosity 30 cSt and specific gravity 0,86 Kg/dm³; for fluids with different features, please consider the factors described in the first part of this catalogue. All the curves

are obtained from test done at the UFI HYDRAULIC DIVISION Laboratory, according to the specification ISO 3968. In case of discrepancy, please check the contamination level, viscosity and features of the fluid in use.

RETURN FILTERS

CLOGGING INDICATORS

INDICATOR SERIE		DESCRIPTION	FOR RETURN FILTERS SERIES	
NBR	FKM	Differential ELECTRICAL indicators with THERMOSTAT 30° C		
T0	DB	Setting 1,3 bar (130 kPa)	FRF RFC	
T1	DC	Setting 2 bar (200 kPa)	FRD MRH	
<p>SPDT differential switch. C.C. 14 - 30 V: > max resistive or inductive load 4 - 3 A respectively C.A. 125-250 V: > max resistive or inductive load 1 A - Protection IP65 - Connector DIN 43650</p>				
NBR	FKM	Differential VISUAL ELECTRICAL indicators		
70	E0	Setting 1,3 bar (130 kPa)	FRF RFC	
71	E1	Setting 2 bar (200 kPa)	FRD MRH	
<p>SPDT differential switch. C.C. 14 - 30 V: > max resistive or inductive load 4 - 3 A respectively C.A. 125-250 V: > max resistive or inductive load 1 A - Protection IP65 - Connector DIN 43650</p>				
NBR	FKM	Differential ELECTRICAL indicators ATEX		
008.0239.2	-	Setting 1,3 bar (130 kPa)	FRF RFC	
008.0234.2	-	Setting 2 bar (200 kPa)	FRD MRH	
<p>SPDT differential switch. C.C. 14 - 30 V: > max resistive or inductive load 4 - 3 A respectively C.A. 125-250 V: > max resistive or inductive load 1 A - Protection IP65 - Connector DIN 43650</p>				