

Part number:

RS(E)H4 - 10

DIRECTIONAL CONTROL VALVES

| KE 2031 | 10/14 |

D_n 10 mm | p_{max} 32 MPa | Q_n 160 dm³/min

Pilot or hydraulic operated directional control valves RS(E)H4-10 are used to control start, stop and direction of flow in hydraulic circuit.

Installation dimensions according to DIN 24 340, ISO 4401, CETOP RP 121H-05 | pilot or hydraulic control | high reliability | manual override (only for RSEH) any working position

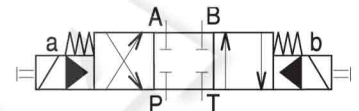

FUNCTIONAL DESCRIPTION

Pilot operated directional control valves RSEH4-10 consist of solenoid operated directional control valve RSE4-06 (see KE2020) and the main valve with connection surface according to ISO 4401 (CETOP 5), whereas RSH4-10 valves consist of the main valve only. Both pilot and hydraulic operated directional control valves are available in several configurations and spool types. To avoid pressure surges in hydraulic system the spool switching time of the main valve can be adjusted using orifices or double throttle check valve in both manners of control (see ordering code). Both pilot and drain connection can be either internal or external. Surface treatment of pilot and main valve housing is phosphate coated, solenoids of type RSEH are zinc coated.

ORDERING CODE

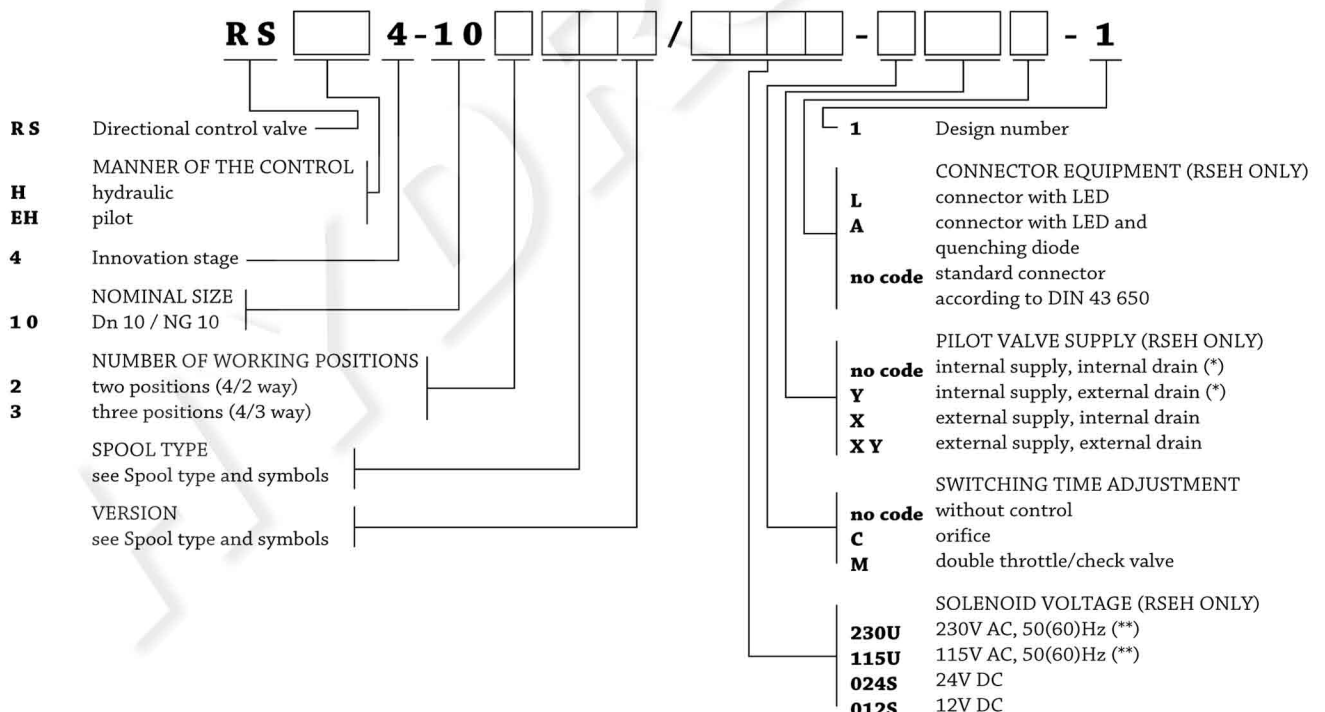

(*) Not for spool types: C1, C2, L1, L2
(**) Connector with rectifier

PILOT VALVE

The pilot valve can either be two or three positional. Two positional (4/2 way) pilot valves are manufactured in the one or two solenoid configuration. Control spool of the two positional pilot valve with one solenoid is moved in one direction by a solenoid and returned back to its initial position by a spring. Control spool of two positional pilot valves with two solenoids is moved between two end positions. For special application, 2 solenoid 4/2 way pilot valve is also available with detent assembly in both end position. The spool of such a valve is held in one of the end positions until being released and moved to the opposite end position. Control spool of 3 positional (4/3 way) pilot valve is moved from its central position in both direction to the left or right end position by one of two solenoids and returned back to its central position by springs. For safety purposes the solenoids are equipped with manual override.

MAIN VALVE

Number of positions of the pilot valve determines number of positions of the main valve. Control spool of 4/2 way main valve is either positioned between initial and end position by one-solenoid pilot valve or between two end positions by two-solenoid pilot valve (with/without detent assembly in both end positions). The control spool of 4/3 way main valve is held in the central position by two springs and moved to the end positions by the pressure from pilot valve. As soon as the pilot pressure relieves, the main spool returns to the initial (central position). The pilot and the drain connections can be internal or external:

- internal drain, internal pilot: T ports of both valves are connected, control and working pressure are the same,
- internal drain, external pilot: T ports of both valves are connected, control and working pressure are independent,
- external drain, internal pilot: T port (pilot) connected to port Y (main), control and working pressure are the same,
- external drain, external pilot: T port (pilot) connected to port Y (main), control and working pressure are independent.

DOUBLE THROTTLE/CHECK VALVE

To avoid pressure surges in the hydraulic system controlled by directional control valve of type RS(E)H, the speed of main spool movement needs to be reduced using double throttle/check valve of sandwich plate design. Such a device consists of two opposite located throttle check valves that limit flow in one direction and provide free return in reverse direction. The flow rate in both channels is adjusted by the screw with internal hexagon. Installation dimensions of double throttle/check valve corresponds with Dn06/NG06 (CETOP 3) size. The valve can be used according to the desired throttled port. Both check valves in port A and B are equally arranged in the valve body (arrangement matches the symbol on the nameplate of the valve).

DELIVERY

Directional control valves RSEH4-10 are delivered assembled. Spare parts and mounting screws are not included in the package. These must be ordered separately.

INSTALLATION, SERVICE, MAINTENANCE

Directional control valves RSEH4-10 are designed for panel installation. They are being mounted by 4 screws M6x50 DIN 912-10.9 with torque 14Nm. Valves can be installed in any working position. The reliability of the valves is conditional upon use of prescribed working fluid, especially its parameters such as purity and temperature. It is required that the contact surfaces of the valve must be clear and intact before installation. O-rings must not be disshaped or damaged by any means. Flatness deviation and roughness of the subplate shall not exceed 0,01/100 mm and Ra = 1,6 µm respectively. Directional control valves RSEH4-10 do not require any special maintenance.

SPOOL TYPE

In the ordering code, the spool type is understood as the spool type of the main valve. The spool type together with its position determine the interconnection of P, A, B, T channels.

TECHNICAL DATA

Technical data	Symbol	Unit	Value
Nominal size	Dn	mm	10
Max. flow	Q _{MAX}	dm ³ /min	160
Max. operating pressure in ports P, A, B	P _{MAX}	Mpa	32
Max. operating pressure in port T internal pilot oil drain external pilot oil drain	P _{MAX,T}	MPa	16 25
Max. pressure in port X internal pilot oil supply external pilot oil supply	P _{MAX,X}	MPa	32 32
Max. pressure in port Y RSEH RSH	P _{MAX,Y}	MPa	16 25
Hydraulic fluid	Hydraulic oils of power classes (HL, HLP) according to DIN 51524		
Pressure drop	Δp	MPa	see Δp = f(Q) curves
Min. required pilot pressure	P _{MIN}	MPa	0,5
Viscosity range	v	mm ² /s	10 ... 400
Maximum degree of fluid contamination	Class 21/18/15 according to ISO 4406 (1999)		
Fluid temperature range RSEH RSH	t _{PO}	°C	-20...+60 -20...+80
Ambient temperature range RSEH RSH	t _A	°C	-20...+50 -20...+70
Weight (without throttle valve interplate) RSEH4-103, RSEH4-102K RSEH4-102 RSH 4-10	m	kg	6.3 5.6 4
Weight of the throttle valve interplate	m	kg	1.1
Mounting position			optional
Protection degree according to EN 60 529			IP65

Note: measured at v = 35mm²/s, T = 50°C

ELECTRICAL DATA

Technical data	Symbol	Unit	Value	
Nominal voltage of solenoids	U _N	V	12, 24, 48 (DC)	48, 110, 230 (AC)
Nominal voltage frequency	f _N	Hz		50, 60
Nominal power input	P _N	W	30	
Voltage ripple	ΔU	%	±10%	
Maximal switching frequency	f _{SM}	1/h	10000	7200
Switching time (on)	t ₀ (T ₄)	ms	up to 80	up to 60
Switching time (off)	t ₀ (T ₃)	ms	up to 100	up to 120

Note: Switching time according to ISO 6403

OPERATING LIMITS

Note: measured at $v = 35\text{mm}^2/\text{s}$, $T = 50^\circ\text{C}$, pilot pressure: 1.2MPa

Typ of spool	Flow Q [dm ³ /min] at the pressure p [MPa]	
	20	32
Other spools	160	160
H1, L1, C1, C2	140	100

PRESSURE DROP $\Delta p = f(Q)$

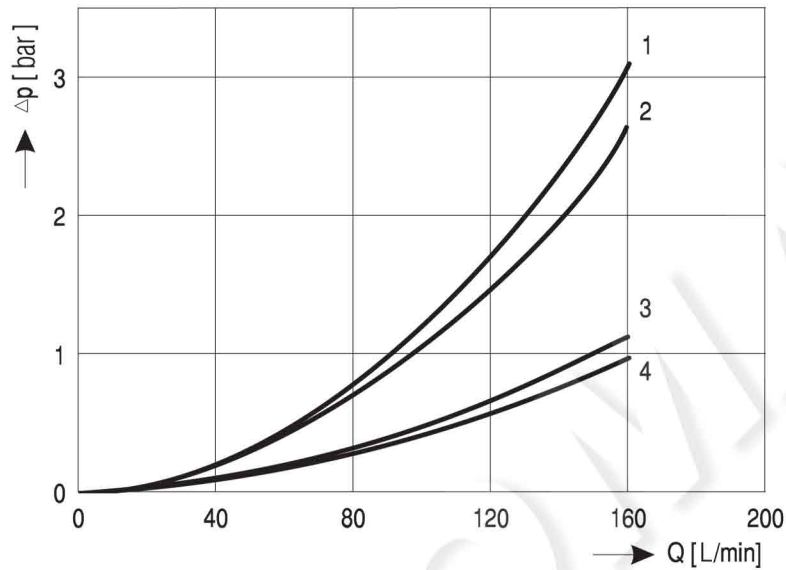



Note: average values with upper deviation 20%, measured at $v = 35\text{mm}^2/\text{s}$, $T = 50^\circ\text{C}$,

Curve number	Spool type	Measured flow
1	H12	P → A, P → B, P → T
2	Z12, Y12, X11, R11	P → A, P → B
3	Z12, Y12, H12, X11, R11	A → T ₁
4	Z12, Y12, H12, X11, R11	B → T ₁ , A → T, B → T

SPOOL TYPE AND CROSSOVERS - 4/2 WAY VALVES



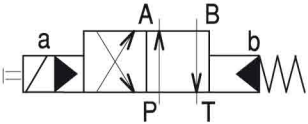
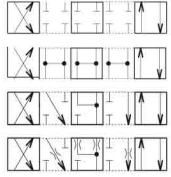
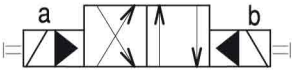
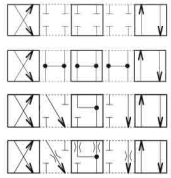

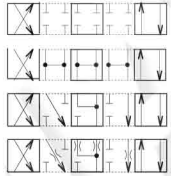
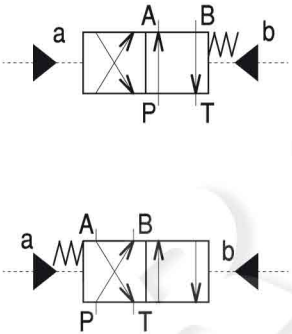
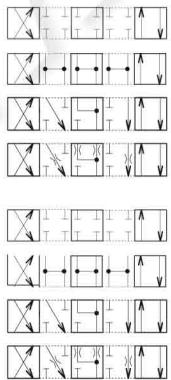
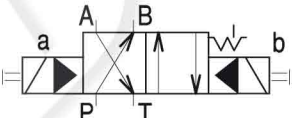
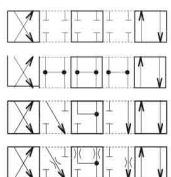
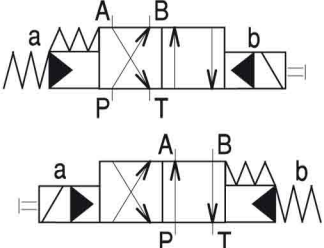
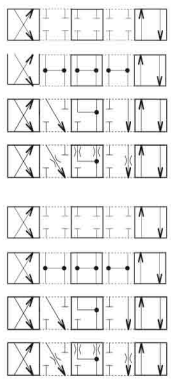





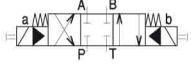
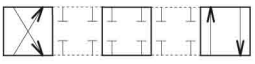
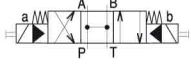
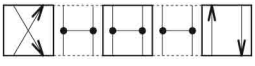
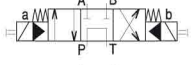
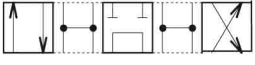
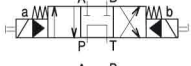
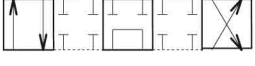

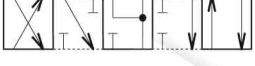
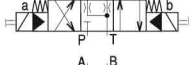
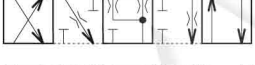





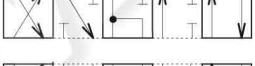



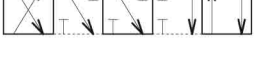
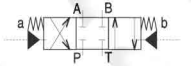
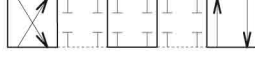

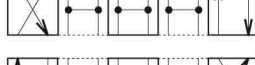

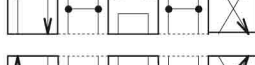
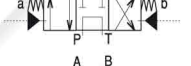
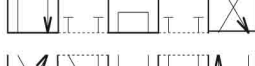

Pilot valve: one solenoid, initial position fixed with the spring

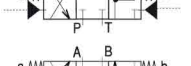
Type	Symbol	Crossover
RSEH 4-102 X 11		
RSEH 4-102 X 21		
RSEH 4-102 X 31		
RSEH 4-102 X 41		

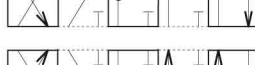
Type	Symbol	Crossover
RSEH 4-102 R 11 RSEH 4-102 R 21 RSEH 4-102 R 31 RSEH 4-102 R 41		
Pilot valve: two solenoids, initial position indefinite		
RSEH 4-102 K 14 RSEH 4-102 K 24 RSEH 4-102 K 34 RSEH 4-102 K 44		
RSH - initial position indefinite		
RSH 4-102 K 14 RSH 4-102 K 24 RSH 4-102 K 34 RSH 4-102 K 44		
RSH - initial position fixed by spring		
RSH 4-102 R 11 RSH 4-102 R 21 RSH 4-102 R 31 RSH 4-102 R 41 RSH 4-102 X 11 RSH 4-102 X 21 RSH 4-102 X 31 RSH 4-102 X 41		
Pilot valve with detent assembly, initial position indefinite		
RSEH 4-102 K 15 RSEH 4-102 K 25 RSEH 4-102 K 35 RSEH 4-102 K 45		
Pilot valve with one solenoid, initial position fixed by spring		
RSEH 4-102 R 12 RSEH 4-102 R 22 RSEH 4-102 R 32 RSEH 4-102 R 42 RSEH 4-102 X 12 RSEH 4-102 X 22 RSEH 4-102 X 32 RSEH 4-102 X 42		

SPOOL TYPE AND CROSSOVERS - 4/3 WAY VALVES

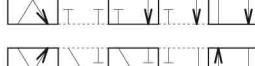
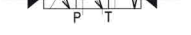
Pilot valve with 2 solenoids, initial position fixed by springs

Type	Symbol	Crossover
RSEH 4-103 Z 12		
RSEH 4-103 H 12		
RSEH 4-103 C 12		
RSEH 4-103 C 22		
RSEH 4-103 Y 12		
RSEH 4-103 Y 22		
RSEH 4-103 Z 22		
RSEH 4-103 P 12		
RSEH 4-103 L 12		
RSEH 4-103 B 12		
RSEH 4-103 N 12		
RSH, initial position fixed by springs		
RSH 4-103 Z 11		
RSH 4-103 H 11		
RSH 4-103 C 11		
RSH 4-103 C 21		
RSH 4-103 Y 11		
RSH 4-103 Y 21		
RSH 4-103 Z 21		
RSH 4-103 P 11		
RSH 4-103 L 11		
RSH 4-103 B 11		
RSH 4-103 N 11		

INTERNAL CONNECTION OF RSEH4-102

diagrams apply to valves with internal pilot oil supply (X) and internal pilot oil drain (Y)

RSEH 4-102X × 1/

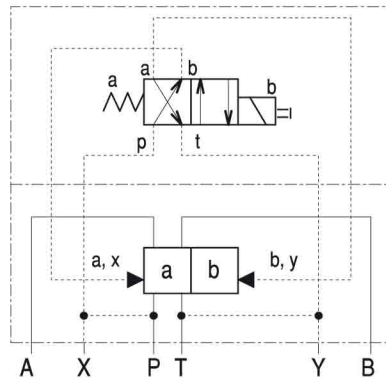

RSEH 4-102R × 1/

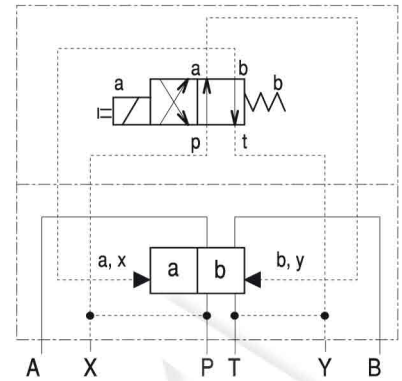

RSEH 4-102X × 2/

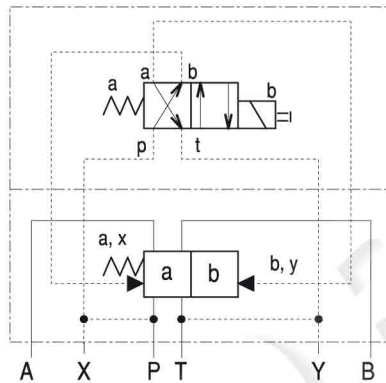

RSEH 4-102R × 2/

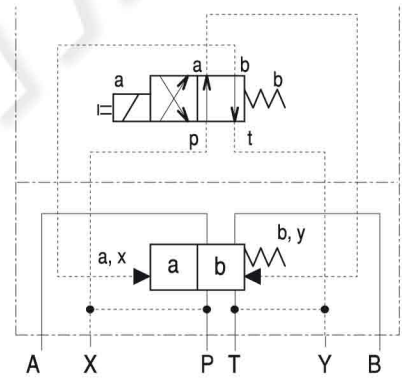

RSEH 4-102K × 4/

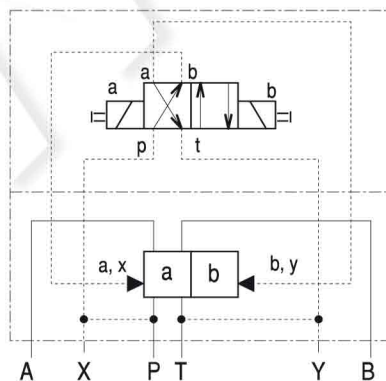

RSEH 4-102K × 5/

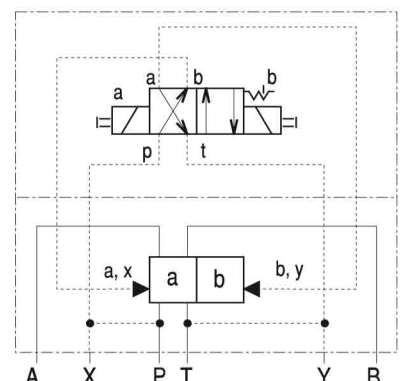

INTERNAL CONNECTION OF RSEH4-103

Internal pilot oil supply (X),
internal pilot oil drain (Y)

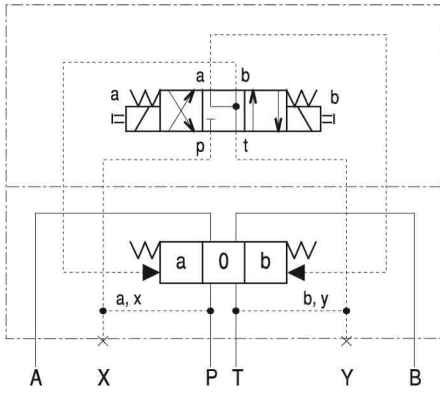

Code: no code

Symbol:

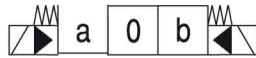

External pilot oil supply (X),
internal pilot oil drain (Y)

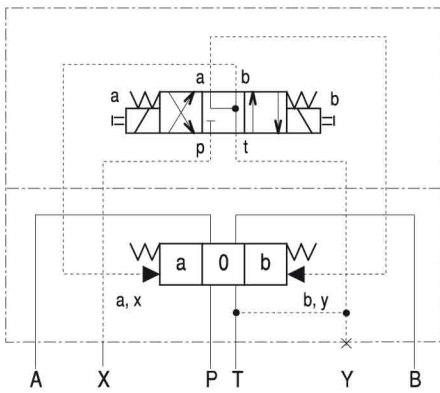

Code: X

Symbol:

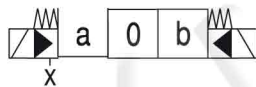

Internal pilot oil supply (X),
external pilot oil drain (Y)

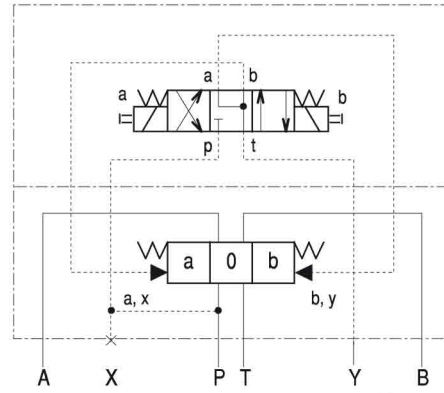

Code: Y

Symbol:



External pilot oil supply (X),
external pilot oil drain (Y)

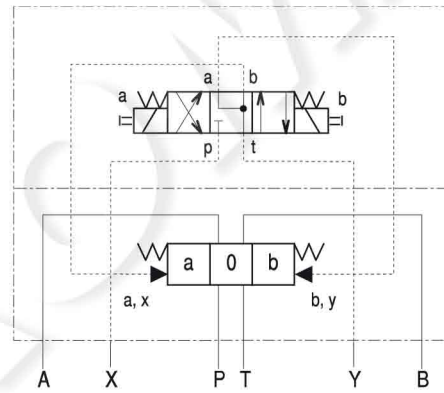

Code: XY

Symbol:

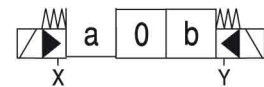
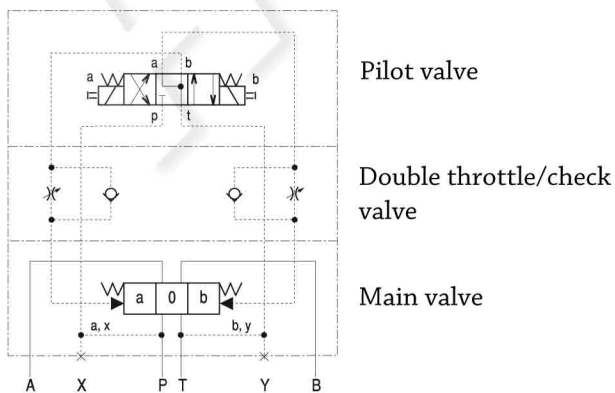

DIAGRAM WITH DOUBLE THROTTLE/CHECK VALVE

Example of electro-hydraulically operated valve

RSEH 4 -103xxx/xxxx - Mxx-1



Example of hydraulically operated valve

RSH 4 -103xxx/M-1

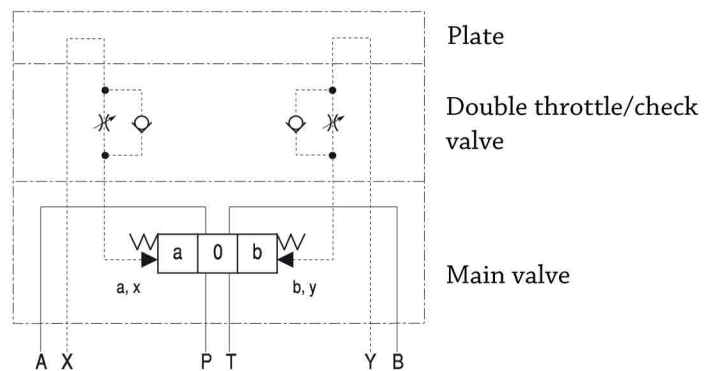

MAIN VALVE CROSS SECTION

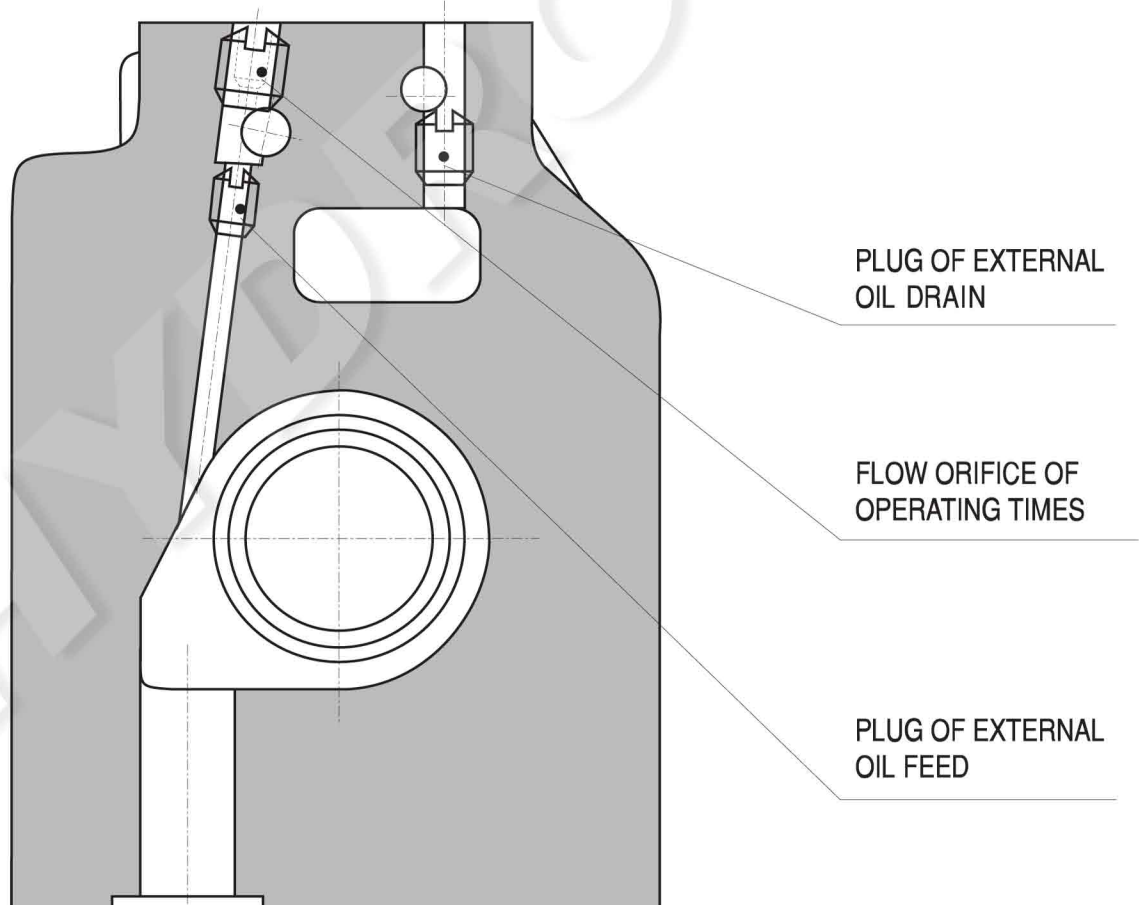
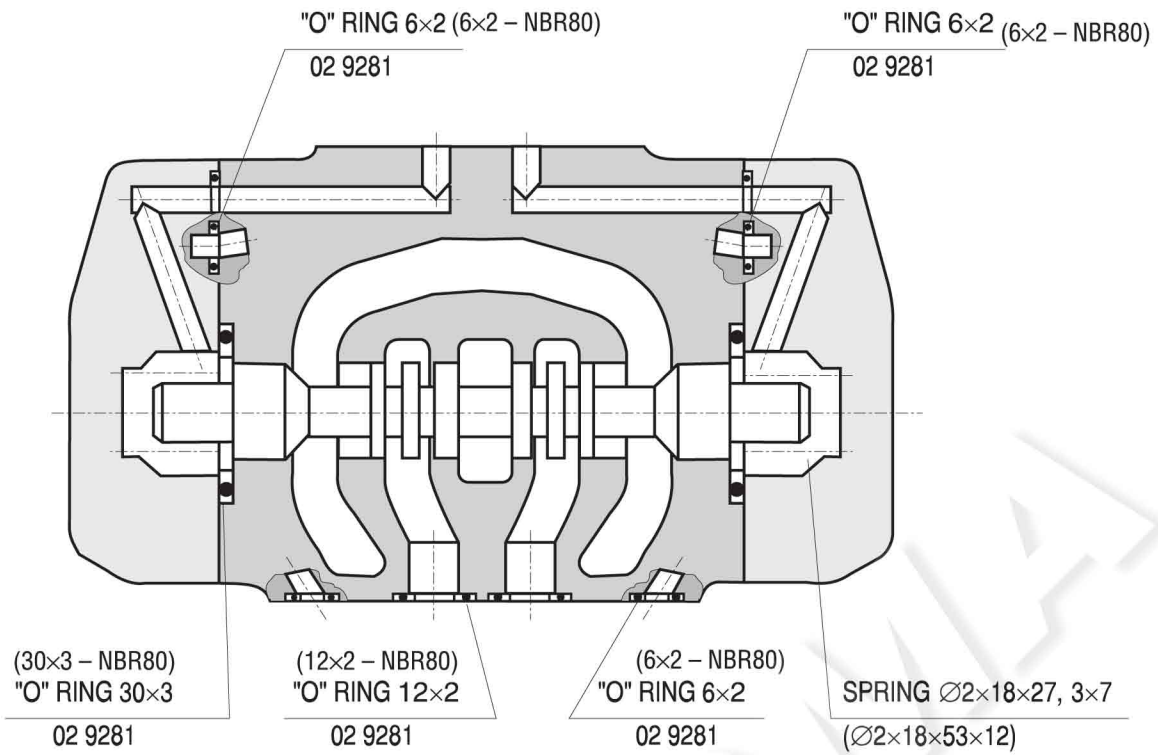

DIMENSIONS RSH4-10

Note: All dimensions in [mm]

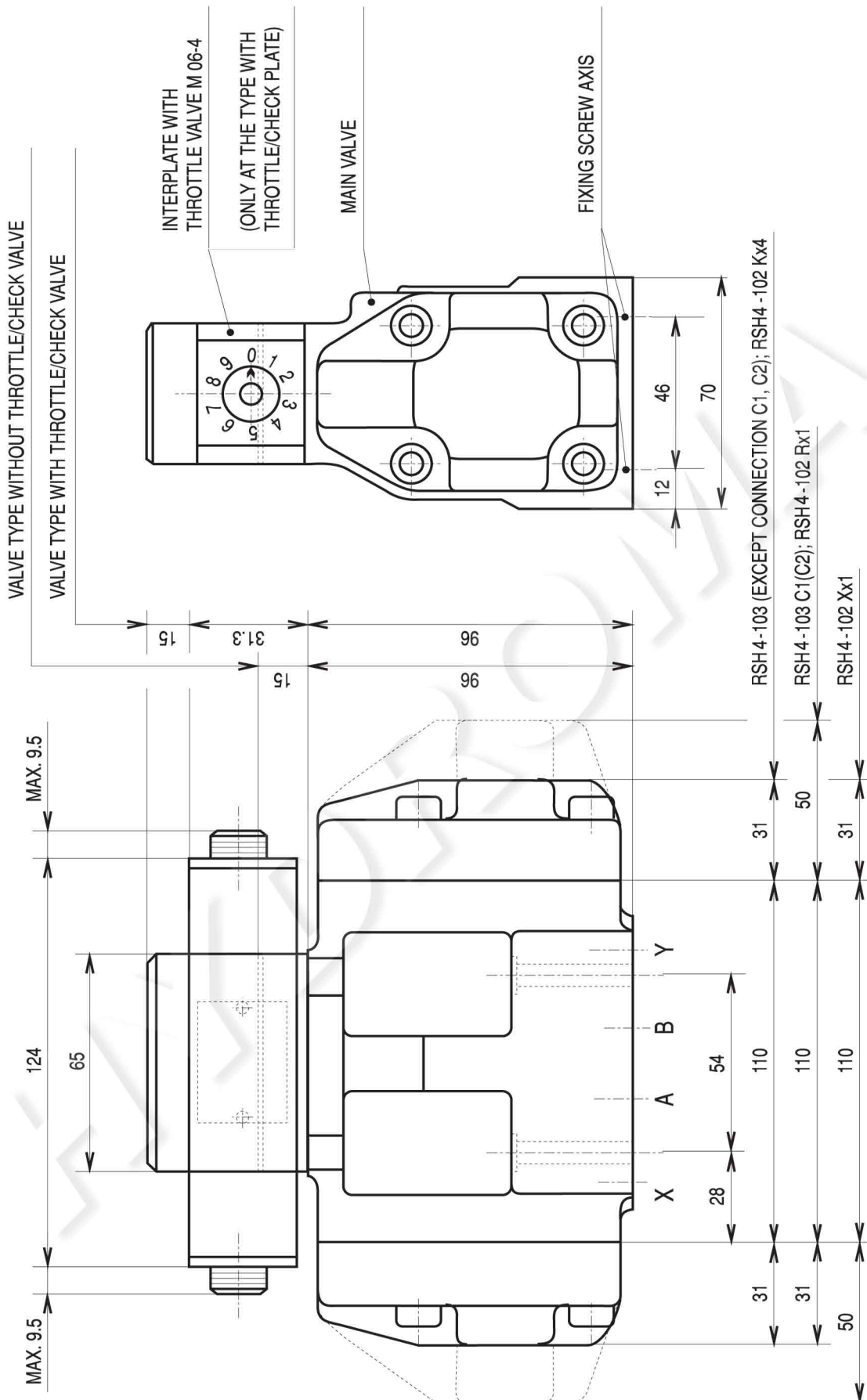

INSTALLATION DIMENSIONS

Note: All dimensions in [mm]

Note: view towards panel

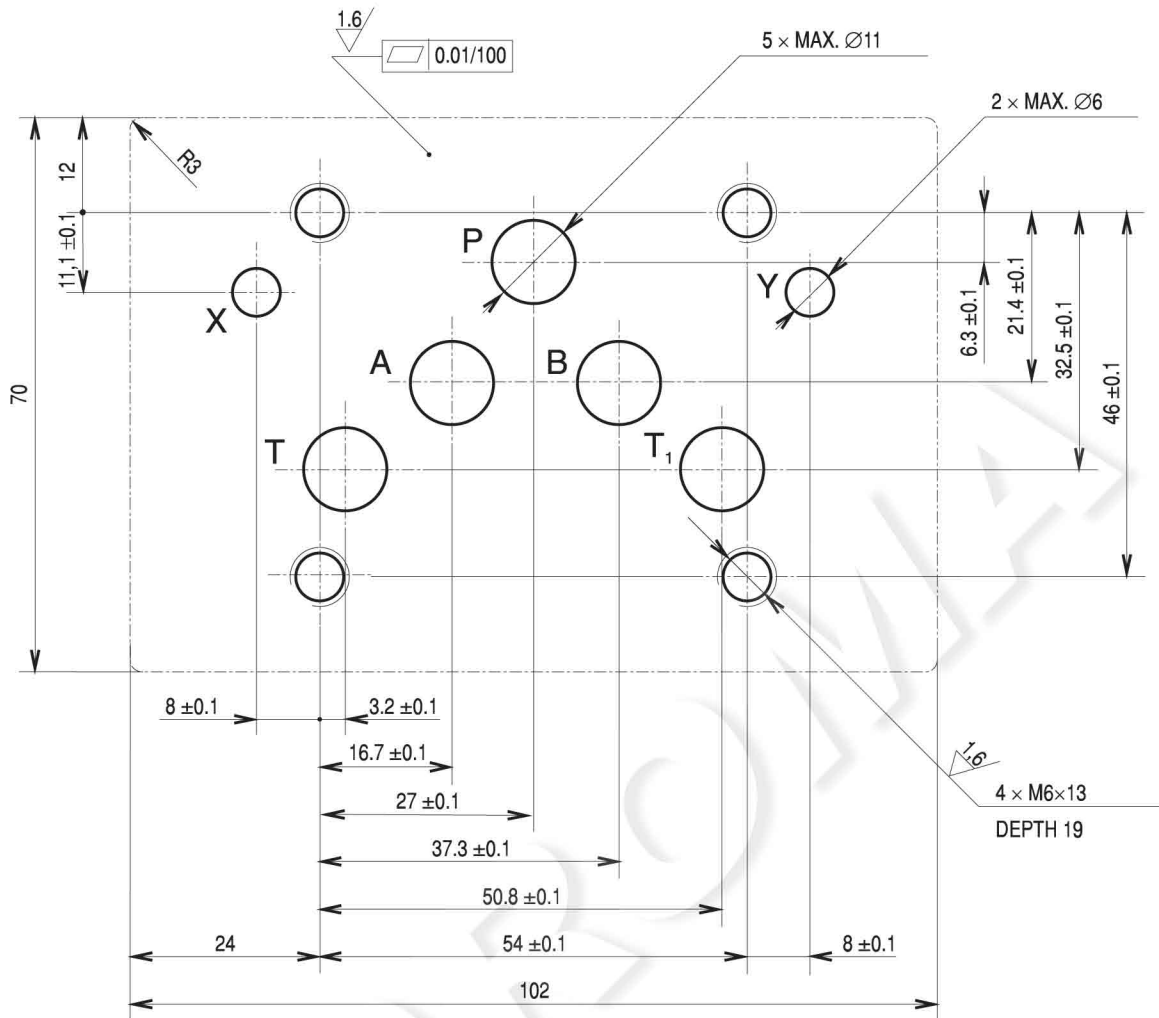

Port designation:

- P..... main valve pressure fluid input port
- A,B.... controlled elements ports
- T..... tank port
- X..... pilot pressure input
- Y..... pilot pressure drain