

Part number:

**074-10659**

**HYDROMA**

HYDRAULICKÉ SYSTÉMY

**HIDROMA  
SYSTEMS**

UKŁADY HYDRAULICZNE

**HYDROMA**

ГИДРАВЛИЧЕСКИЕ СИСТЕМЫ

• **Materials**

Body: Carbon Steel EN -10277-3

Seals: NBR, Viton or EPDM

Back-Up-Ring: PTFE

Balls: AISI 1010/1015

Springs: Carbon Steel

DIN 17233/84(B)

• **Working temperature (Seals)**

	NBR	Viton	EPDM
	+100°C	+200°C	+150°C
	-30°C	-10°C	-40°C

• **Applications:** Designed for Oil hydraulic Applications according to European Directive 97.23.EC

• **Sectors:** Industrial, Agricultural



• **Equivalence**

FASTER ANV

AEROQUIP FD56

PARKER 6600

SNAP-TITE 61

**MODEL STRUCTURE**

Example;

**102.11112 JE**

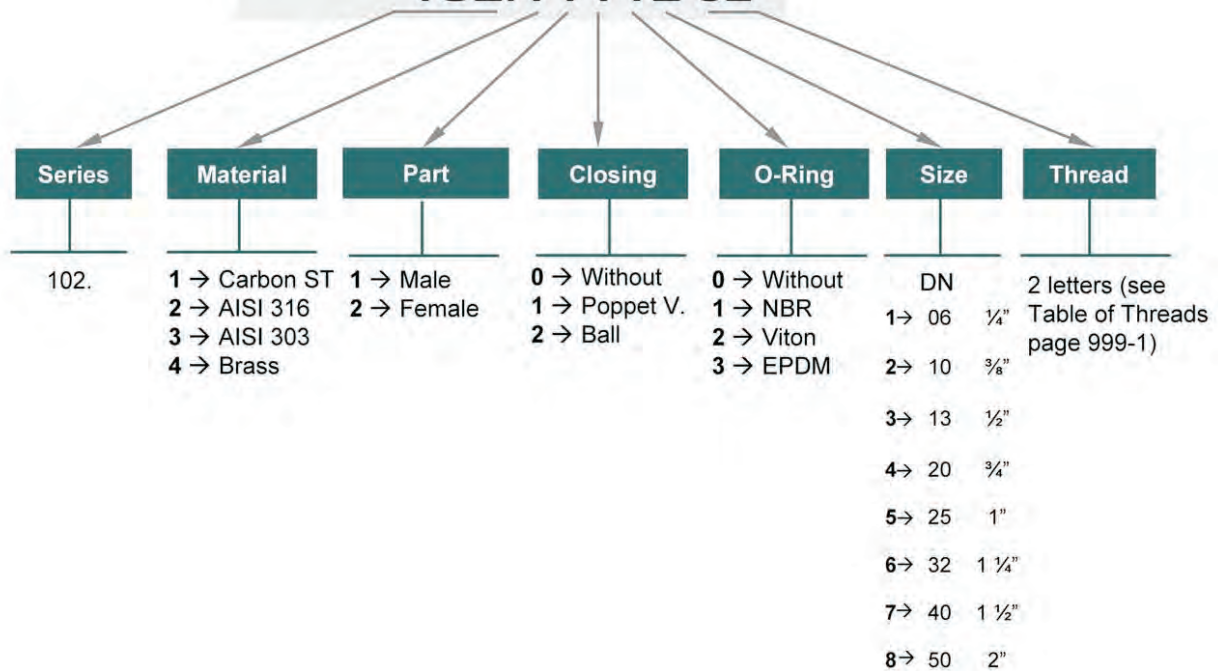

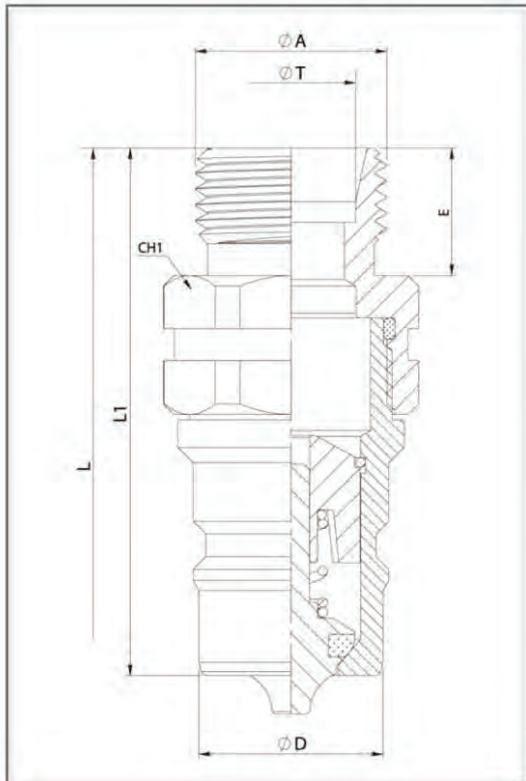

STANDARD MALE MODELS														
DN	ØA	ØT	REF.		CH1	L1	ØD	E	L					
06	M12x1,5	6L	102.11111JB	350Bar	19	*	11,8	12	*					
	M14x1,5	8L	102.11111JC											
	M18x1,5	12L	102.11112JE											
10	M14x1,5	8L	102.11112JC	300Bar	22	*	17,25	12	*					
	M16x1,5	10L	102.11112JD											
	M18x1,5	12L	102.11112JE											
13	M14x1,5	8L	102.11113JC	300Bar	27	*	20,56	12	*					
	M16x1,5	10L	102.11113JD											
	M18x1,5	12L	102.11113JE											
	M22x1,5	15L	102.11113JG											
	M26x1,5	18L	102.11113JI											
20	M18x1,5	12L	102.11114JE	250Bar	36	*	29	12	*					
	M22x1,5	15L	102.11114JG					18						
	M26x1,5	18L	102.11114JI					12						
	M30x2	22L	102.11114JJ					18						
	M26x1,5	18L	102.11115JI					12						
25	M30x2	22L	102.11115JJ	230Bar	41	*	34,3	18	*					
	M36x2	28L	102.11115JK					16						
	M45x2	35L	102.11115JM					16						
	M16x1,5	8S	102.11112KD					300Bar		22	*	17,25	12	*
	M18x1,5	10S	102.11112KE											
M20x1,5	12S	102.11112KF												
M18x1,5	10S	102.11113KE												
M20x1,5	12S	102.11113KF												
13	M22x1,5	14S	102.11113KG	300Bar	27	*	20,56	12	*					
	M24x1,5	16S	102.11113KH											
	M24x1,5	16S	102.11114KH											
20	M30x2	20S	102.11114KJ	250Bar	36	*	29	12	*					
	M30x2	20S	102.11115KJ					16						
	M36x2	25S	102.11115KK					18						
25	M42x2	30S	102.11115KL	230Bar	41	*	34,3	18	*					
	M42x2	30S	102.11115KL					46						
	M52x2	38S	102.11115KN					55						

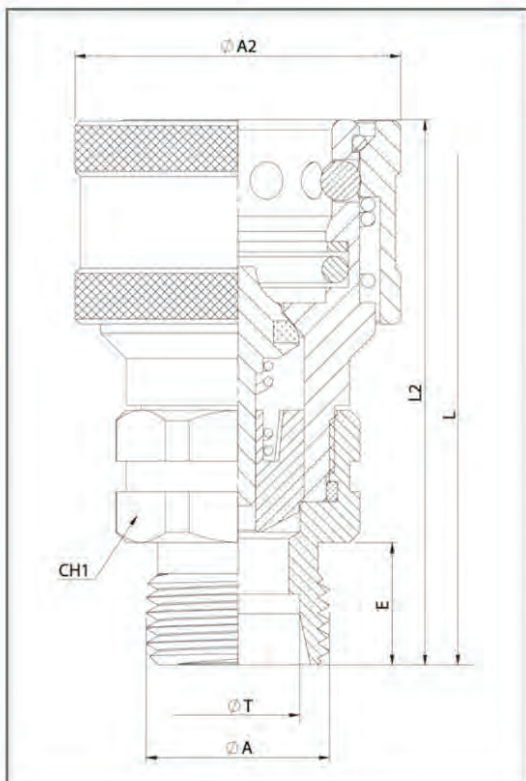

STANDARD FEMALE MODELS														
DN	ØA	ØT	REF.		CH1	L2	ØA2	E	L					
06	M12x1,5	6L	102.12111JB	350Bar	19	*	26	12	*					
	M14x1,5	8L	102.12111JC											
	M18x1,5	12L	102.12112JE											
10	M14x1,5	8L	102.12112JC	300Bar	22	*	32	12	*					
	M16x1,5	10L	102.12112JD											
	M18x1,5	12L	102.12112JE											
13	M14x1,5	8L	102.12113JC	300Bar	27	*	38	12	*					
	M16x1,5	10L	102.12113JD											
	M18x1,5	12L	102.12113JE											
	M22x1,5	15L	102.12113JG											
	M26x1,5	18L	102.12113JI											
20	M18x1,5	12L	102.12114JE	250Bar	36	*	46	12	*					
	M22x1,5	15L	102.12114JG					18						
	M26x1,5	18L	102.12114JI					12						
	M30x2	22L	102.12114JJ					18						
	M26x1,5	18L	102.12115JI					12						
25	M30x2	22L	102.12115JJ	230Bar	41	*	55	18	*					
	M36x2	28L	102.12115JK					16						
	M45x2	35L	102.12115JM					16						
	M16x1,5	8S	102.12112KD					300Bar		22	*	32	12	*
	M18x1,5	10S	102.12112KE											
M20x1,5	12S	102.12112KF												
M18x1,5	10S	102.12113KE												
M20x1,5	12S	102.12113KF												
13	M22x1,5	14S	102.12113KG	300Bar	27	*	38	12	*					
	M24x1,5	16S	102.12113KH											
	M24x1,5	16S	102.12114KH											
20	M30x2	20S	102.12114KJ	250Bar	36	*	46	12	*					
	M30x2	20S	102.12115KJ					16						
	M36x2	25S	102.12115KK					18						
25	M42x2	30S	102.12115KL	230Bar	41	*	55	18	*					
	M42x2	30S	102.12115KL					46						
	M52x2	38S	102.12115KN					55						



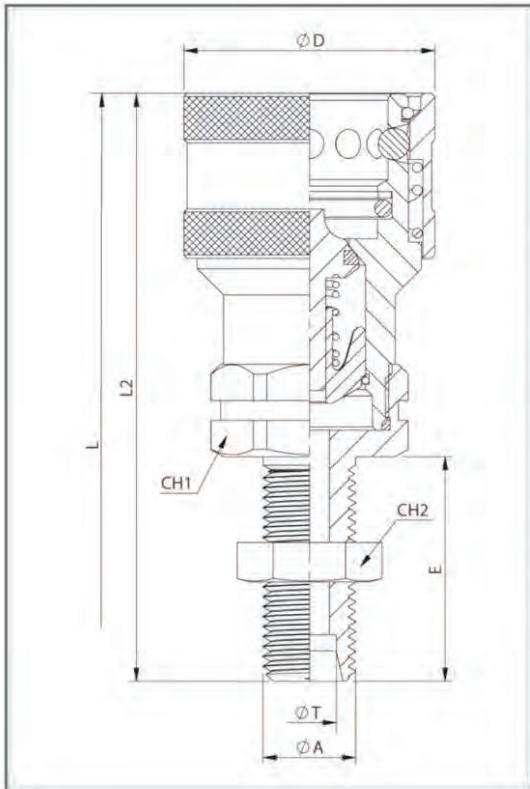
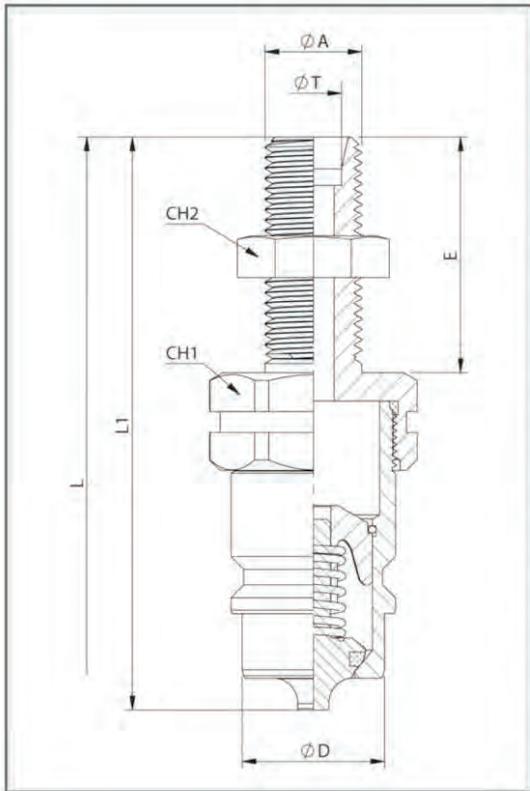

### STANDARD MALE MODELS

DN	$\varnothing A$	$\varnothing T$	REF.		CH1	CH2	L1	$\varnothing D$	E	L	Light Series	
06	M12x1,5	6L	102.11111LB	350Bar	19	19	*	11,8	25	*		
	M14x1,5	8L	102.11111LC						34			
	M14x1,5	8L	102.11112LC						34			
10	M16x1,5	10L	102.11112LD	300Bar	22	22	*	17,25	26	*		
	M18x1,5	12L	102.11112LE						27			
	M14x1,5	8L	102.11113LC						19		34	
13	M16x1,5	10L	102.11113LD	300Bar	27	24	*	20,56	35	*		
	M18x1,5	12L	102.11113LE						27		35	
	M22x1,5	15L	102.11113LG						27		33	
	M26x1,5	18L	102.11113LI						30		33	
	M18x1,5	12L	102.11114LE						24		26	
20	M22x1,5	15L	102.11114LG	250Bar	36	27	*	29	33	*		
	M26x1,5	18L	102.11114LI						30		34	
	M30x2	22L	102.11114LJ						36		34	
	M30x2	22L	102.11115LJ						36		34	
25	M36x2	28L	102.11115LK	230Bar	41	41	*	34,3	34	*		
	M45x2	35L	102.11115LM						55		36	
	M16x1,5	8S	102.11112MD						300Bar		22	22
M18x1,5	10S	102.11112ME	24	24								
M20x1,5	12S	102.11112MF	22	24								
13	M18x1,5	10S	102.11113ME	300Bar	27	22	*	20,56	35	*		
	M20x1,5	12S	102.11113MF						22		24	
	M22x1,5	14S	102.11113MG						27		35	
	M24x1,5	16S	102.11113MH						30		35	
20	M24x1,5	16S	102.11114MH	250Bar	36	30	*	29	29	*		
	M30x2	20S	102.11114MJ						36		36	
	M30x2	20S	102.11115MJ						36		35	
	M36x2	25S	102.11115MK						41		38	
25	M42x2	30S	102.11115ML	230Bar	41	50	*	34,3	40	*		
	M42x2	30S	102.11115ML						50		40	
	M52x2	38S	102.11115MN						65		40	

### STANDARD FEMALE MODELS

DN	$\varnothing A$	$\varnothing T$	REF.		CH1	CH2	L2	$\varnothing D$	E	L	Light Series	
06	M12x1,5	6L	102.12111LB	350Bar	19	19	*	11,8	25	*		
	M14x1,5	8L	102.12111LC						34			
	M14x1,5	8L	102.12112LC						34			
10	M16x1,5	10L	102.12112LD	300Bar	22	22	*	17,25	26	*		
	M18x1,5	12L	102.12112LE						27			
	M14x1,5	8L	102.12113LC						19		34	
13	M16x1,5	10L	102.12113LD	300Bar	27	24	*	20,56	35	*		
	M18x1,5	12L	102.12113LE						27		35	
	M22x1,5	15L	102.12113LG						27		33	
	M26x1,5	18L	102.12113LI						30		33	
	M18x1,5	12L	102.12114LE						24		26	
20	M22x1,5	15L	102.12114LG	250Bar	36	27	*	29	33	*		
	M26x1,5	18L	102.12114LI						30		34	
	M30x2	22L	102.12114LJ						36		34	
	M30x2	22L	102.12115LJ						36		34	
25	M36x2	28L	102.12115LK	230Bar	41	41	*	34,3	34	*		
	M45x2	35L	102.12115LM						55		36	
	M16x1,5	8S	102.12112MD						300Bar		22	22
M18x1,5	10S	102.12112ME	24	24								
M20x1,5	12S	102.12112MF	22	24								
13	M18x1,5	10S	102.12113ME	300Bar	27	22	*	20,56	35	*		
	M20x1,5	12S	102.12113MF						22		24	
	M22x1,5	14S	102.12113MG						27		35	
	M24x1,5	16S	102.12113MH						30		35	
20	M24x1,5	16S	102.12114MH	250Bar	36	30	*	29	29	*		
	M30x2	20S	102.12114MJ						36		36	
	M30x2	20S	102.12115MJ						36		35	
	M36x2	25S	102.12115MK						41		38	
25	M42x2	30S	102.12115ML	230Bar	41	50	*	34,3	40	*		
	M42x2	30S	102.12115ML						50		40	
	M52x2	38S	102.12115MN						65		40	

Light Series

Heavy Series

Light Series

Heavy Series

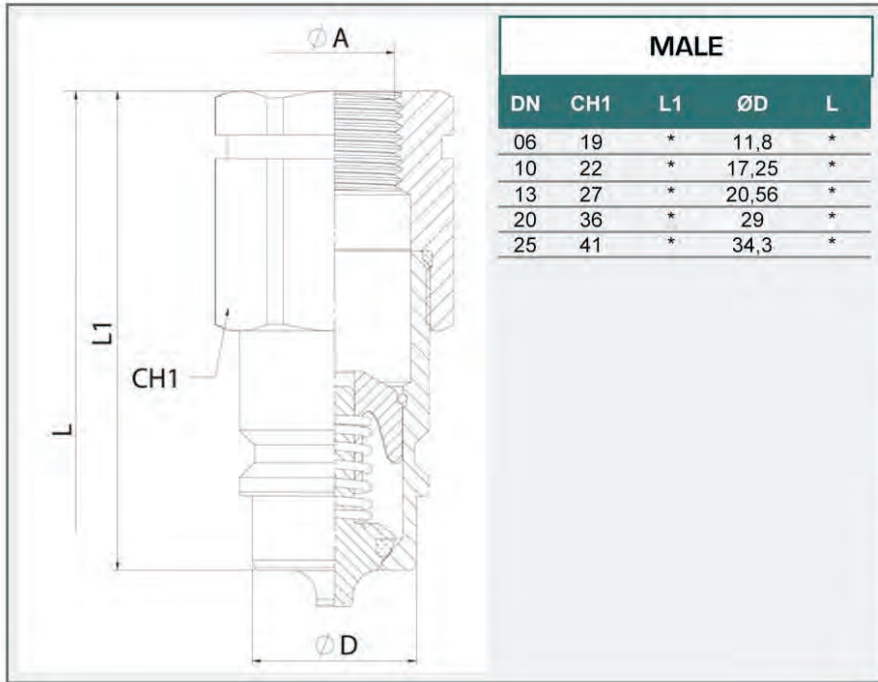

MALE				
DN	CH1	L1	ØD	L
06	19	*	11,8	*
10	22	*	17,25	*
13	27	*	20,56	*
20	36	*	29	*
25	41	*	34,3	*

STANDARD MODELS				
DN	ØA	MALE	FEMALE	
06	1/4" BSP	102.11111AB	102.12111AB	350Bar
	1/4" NPTF	102.11111BB	102.12111BB	
	M14x1,5	102.11111NC	102.12111NC	
10	1/4" BSP	102.11112AB	102.12112AB	300Bar
	3/8" BSP	102.11112AC	102.12112AC	
	3/8" NPTF	102.11112BC	102.12112BC	
13	M16x1,5	102.11112ND	102.12112ND	300Bar
	3/8" BSP	102.11113AC	102.12113AC	
	1/2" BSP	102.11113AD	102.12113AD	
13	1/2" NPTF	102.11113BD	102.12113BD	300Bar
	M18x1,5	102.11113NE	102.12113NE	
	M22x1,5	102.11113NG	102.12113NG	
20	3/4" -16ORB	102.11113GF	102.12113GF	230Bar
	3/8" -14ORB	102.11113GH	102.12113GH	
	3/4" BSP	102.11114AE	102.12114AE	
20	3/4" NPTF	102.11114BE	102.12114BE	230Bar
	M22x1,5	102.11114NG	102.12114NG	
25	3/4" BSP	102.11115AE	102.12115AE	230Bar
	1" BSP	102.11115AF	102.12115AF	
	1" NPTF	102.11115BF	102.12115BF	

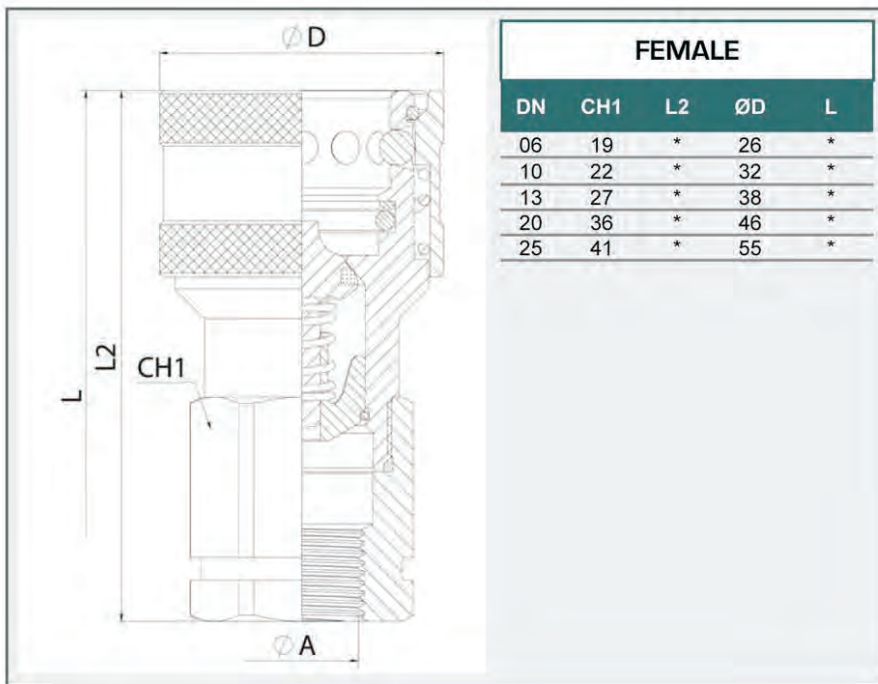

FEMALE				
DN	CH1	L2	ØD	L
06	19	*	26	*
10	22	*	32	*
13	27	*	38	*
20	36	*	46	*
25	41	*	55	*