

Part number:

HYDROMA

HYDRAULICKÉ SYSTÉMY

**HIDROMA
SYSTEMS**

UKŁADY HYDRAULICZNE

HYDROMA

ГИДРАВЛИЧЕСКИЕ СИСТЕМЫ

ALP3

COME ORDINARE / HOW TO ORDER

ALP3	TIPO TYPE	ROTAZIONE ROTATION	TAGLIA SIZE	ALBERO* SHAFT*	PORTE* PORTS*	GUARNIZIONI* SEALS*	OPZIONI* OPTIONS*	DRENAGGIO DRAIN
	omit	D DESTRA CLOCKWISE	30					
	A	S SINISTRA COUNTER CLOCKWISE	33					
		R** REVERSIBILE REVERSIBLE	40					
			50					
			60					
			66					
			80					
			94					
			110					
			120					
			135					

Guarnizioni / Seals
omit (T range = -10°C + 80°C)
V
...

Opzioni / Options
TR
...

**Drenaggio (solo per rotazione R)
Drain (only for R rotation)**
E0 = drenaggio interno / internal drain
E1 = drenaggio esterno / external drain G3/8
***E2 = drenaggio esterno / external drain 3/4-16 UNF
...

(*) = campi da specificare se diversi dallo standard "tipo pompa" / to be specified if different from standard pump type
(**) = la rotazione reversibile R è disponibile per tutte le taglie indicate / R rotation is available for all listed displacements.
(***) = La porta di drenaggio "E2" è lavorata secondo la specifica SAE J1926/1 (ISO 11926-1) relativa a porte filettate con tenuta O-ring. Profondità utile 12,7 mm. / "E2" drain port is machined in compliance with threaded port with O-ring seal in truncated housing SAE J1926/1 (ISO 11926-1). Thread depth 12,7 mm.

Tipi Pompa Standard / Pump Standard Types

omit = flangia europea + albero T0 + porte E + guarnizioni standard / european flange + shaft T0 + ports E + standard seals
A = flangia A + albero C1 + porte A + guarnizioni standard / flange A + shaft C1 + ports A + standard seals

Esempi / Examples:

ALP3-D-30 = pompa destra, 20 cc/rev, flangia europea, albero conico 1:8, porte flangiate tipo E, guarnizioni standard clockwise rotation, 20 cc/rev, european flange, 1:8 tapered shaft, flanged ports E type, standard seals
ALP3-D-30-C0 = pompa destra, 20 cc/rev, flangia europea, albero cilindrico (C0), porte flangiate tipo E, guarnizioni standard clockwise rotation, 20 cc/rev, european flange, cylindrical shaft (C0), flanged ports E type, standard seals
ALP3A-D-30-E = pompa destra, 20 cc/rev, flangia B-2 fori, albero cilindrico, porte flangiate (E), guarnizioni standard clockwise rotation, 20 cc/rev, B 2 bolt flange, cylindrical shaft, european flanged ports (E), standard seals

LE TAVOLE DI PRODOTTO RAPPRESENTANO I TIPI POMPA STANDARD PER MARZOCCHI POMPE. LE TAVOLE SINOTTICHE DI FLANGE, ALBERI E PORTE HANNO LO SCOPO DI RAPPRESENTARE TUTTE LE POSSIBILI CONFIGURAZIONI DI PRODOTTO. PER MAGGIORI DETTAGLI SULLE DISPONIBILITÀ E CONDIZIONI DI FORNITURA, CONSIGLIAMO DI INTERPELLARE IL NOSTRO UFFICIO TECNICO-COMMERCIALE.

THE PRODUCT DATA SHEETS SHOW OUR STANDARD MODEL TYPES. THE SYNOPSIS TABLES FOR FLANGES, SHAFTS AND PORTS SHOW ALL THE POSSIBLE CONFIGURATIONS. FOR FURTHER DETAILS ABOUT THE AVAILABILITY OF EACH CONFIGURATION PLEASE CONTACT OUR SALES AND TECHNICAL DEPT.

ALP3

Parti accessorie a corredo della pompa standard: linguetta a disco (codice 522058), dado M14x1.5 (codice 523017), rosetta elastica spaccata (codice 523006).
 Porte standard: filetti M10 profondità utile 19 mm.

Accessories supplied with the standard pump: woodruff key (code 522058), M14x1.5 exagonal nut (code 523017), washer (code 523006).
 Standard ports: M10 threads depth 19 mm.

MANDATA
 OUTLET

ASPIRAZIONE
 INLET

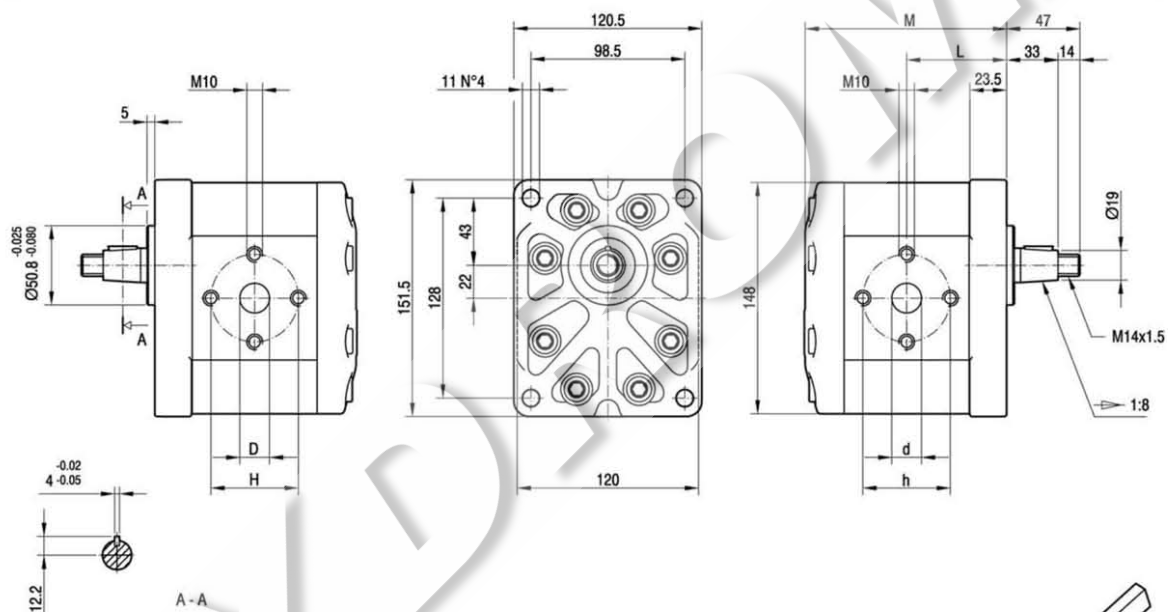

TIPO TYPE	CILINDRATA DISPLACEMENT	PORTATA a 1500 giri/min FLOW at 1500 rev/min	PRESSIONI MASSIME MAX PRESSURE			VELOCITÀ MASSIMA MAX SPEED	DIMENSIONI DIMENSIONS					
			P ₁	P ₂	P ₃		L	M	d	D	h	H
	cm ³ /giro [cm ³ /rev]	litri/min [litres/min]	bar	bar	bar	giri/min [rpm]	mm	mm	mm	mm	mm	mm
ALP3-D-30	20	29	230	250	270	3500	64	129,5	27	19	56	56
ALP3-D-33	22	31	230	250	270	3500	64,5	130,5	27	19	56	56
ALP3-D-40	26	37	230	250	270	3000	66	133,5	27	19	56	56
ALP3-D-50	33	48	230	250	270	3000	68,5	138,5	27	19	56	56
ALP3-D-60	39	56	220	240	260	3000	70,5	142,5	27	19	56	56
ALP3-D-66	44	62	210	230	250	2800	72	145,5	27	27	51	51
ALP3-D-80	52	74	200	215	230	2400	75	151,5	27	27	56	56
ALP3-D-94	61	87	190	205	220	2800	78	157,5	33	27	62	51
ALP3-D-110	71	101	170	185	200	2500	81,5	164,5	33	27	62	51
ALP3-D-120	78	112	160	175	190	2300	84	169,5	33	27	62	51
ALP3-D-135	87	124	140	155	170	2000	87	175,5	33	27	62	51

ALP3A

Parti accessorie a corredo della pompa standard: linguetta (codice 522068).
 Monta flangia 101-2 (B) secondo norma SAE J744c.
 Filetto 1/4-28 UNF profondità utile 20 mm.
 * Porte standard: filetti 3/8-16 UNC profondità utile 19 mm, filetti 7/16-14 UNC profondità utile 19 mm.

Accessories supplied with the standard pump: key (code 522068).
 Mounting flange 101-2 (B) in compliance with SAE J744c.
 1/4-28 UNF thread depth 20 mm.
 * Standard ports: 3/8-16 UNC threads depth 19 mm, 7/16-14 UNC threads depth 19 mm.

MANDATA
OUTLET

ASPIRAZIONE
INLET

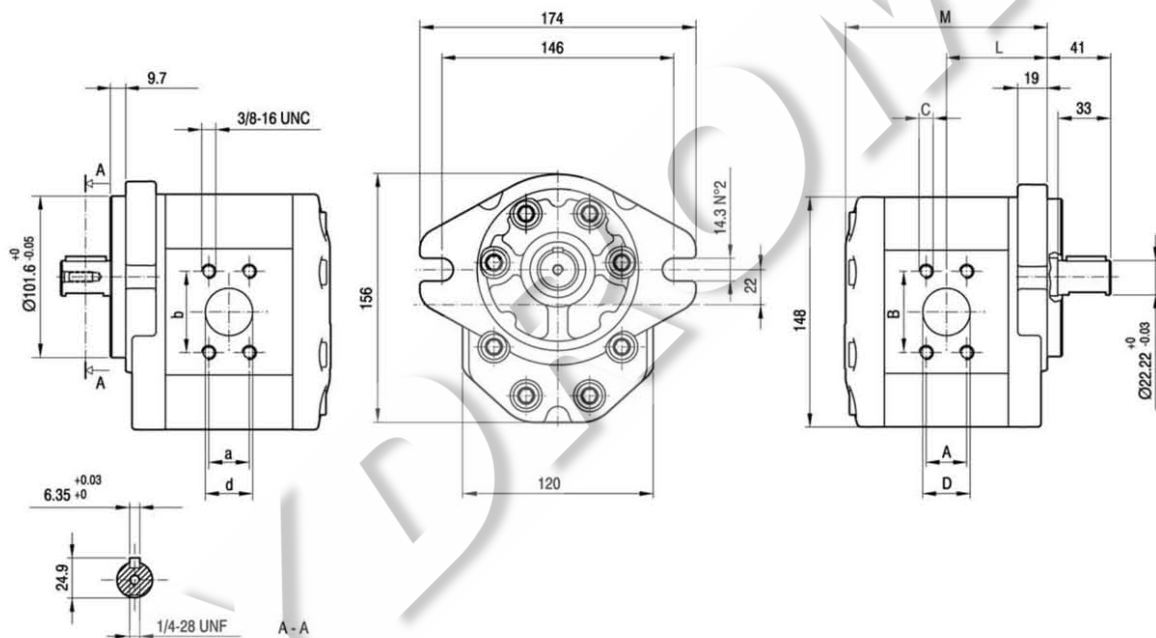

TIPO TYPE	CILINDRATA DISPLACEMENT	PORTATA a 1500 giri/min FLOW at 1500 rev/min	PRESSIONI MASSIME MAX PRESSURE			VELOCITÀ MASSIMA MAX SPEED	DIMENSIONI DIMENSIONS								
			P ₁	P ₂	P ₃		L	M	A	B	*C	D	a	b	d
	cm ³ /giro [cm ³ /rev]	litri/min [litres/min]	bar	bar	bar	giri/min [rpm]	mm	mm	mm	mm	UNC	mm	mm	mm	mm
ALP3A-D-30	20	29	230	250	270	3500	65	130,5	26,19	52,37	3/8	27	22,23	47,63	19
ALP3A-D-33	22	31	230	250	270	3500	65,5	131,5	26,19	52,37	3/8	27	22,23	47,63	19
ALP3A-D-40	26	37	230	250	270	3300	67	134,5	26,19	52,37	3/8	27	22,23	47,63	19
ALP3A-D-50	33	48	230	250	270	3300	69,5	139,5	26,19	52,37	3/8	27	22,23	47,63	19
ALP3A-D-60	39	56	220	240	260	3000	71,5	143,5	26,19	52,37	3/8	27	22,23	47,63	19
ALP3A-D-66	44	62	210	230	250	2800	73	146,5	26,19	52,37	3/8	27	22,23	47,63	19
ALP3A-D-80	52	74	200	215	230	2500	76	152,5	26,19	52,37	3/8	27	22,23	47,63	19
ALP3A-D-94	61	87	190	205	220	2800	79	158,5	30,2	58,7	7/16	33	26,19	52,37	27
ALP3A-D-110	71	101	170	185	200	2500	82,5	165,5	30,2	58,7	7/16	33	26,19	52,37	27
ALP3A-D-120	78	112	160	175	190	2300	85	170,5	30,2	58,7	7/16	33	26,19	52,37	27
ALP3A-D-135	87	124	140	155	170	2000	88	176,5	30,2	58,7	7/16	33	26,19	52,37	27

ALP3

FLANGE / FLANGES

ALBERI / SHAFTS

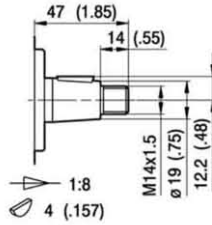
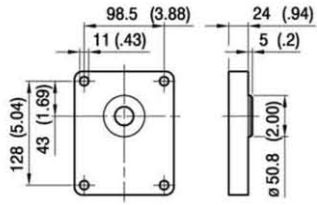

Coppia Max
Max Torque 300 Nm

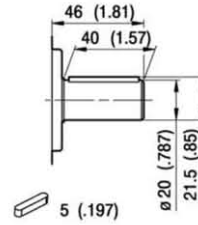

Coppia Max
Max Torque 350 Nm

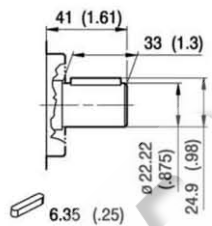
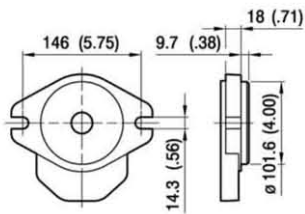

Coppia Max
Max Torque 450 Nm

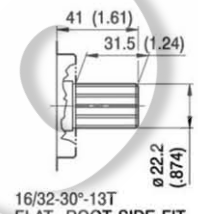

Coppia Max
Max Torque 600 Nm

ALP3

PORTE / PORTS

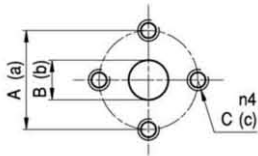

E

TIPO TYPE	ASPIRAZIONE INLET			MANDATA OUTLET		
	A	B	C	a	b	c
ALP3...30 ÷ ALP3...60	56	27	M10	56	19	M10
ALP3...66	51	27	M10	51	27	M10
ALP3...80	56	27	M10	56	27	M10
ALP3...94 ÷ ALP3...135	62	33	M10	51	27	M10

I valori delle coppie di serraggio delle viti presenti nel kit raccordo sono indicate a pag 57 (capitolo accessori).
Tightening torques of the fittings screws are specified on page 57 (accessories section).

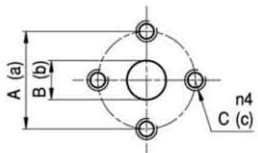

EP

TIPO TYPE	ASPIRAZIONE INLET			MANDATA OUTLET		
	A	B	C	a	b	c
ALP3 ... 30 ÷ ALP3 ... 33	40	19	M8	40	19	M8
ALP3 ... 40 ÷ ALP3 ... 80	51	27	M10	40	19	M8

I valori delle coppie di serraggio delle viti presenti nel kit raccordo sono indicate a pag 57 (capitolo accessori).
Tightening torques of the fittings screws are specified on page 57 (accessories section).

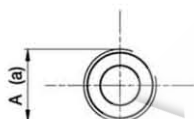

FG

TIPO TYPE	ASPIRAZIONE INLET	MANDATA OUTLET
	A	a
ALP3...30 ÷ ALP3...33	G3/4	G3/4
ALP3...40 ÷ ALP3...60	G1	G3/4
ALP3...66 ÷ ALP3...94	G1 1/4	G1
ALP3...110 ÷ ALP3...135	G1 1/2	G1 1/4

Raccordo G3/4 coppia di serraggio massima 60 Nm. Raccordo G1 coppia di serraggio massima 70 Nm. Raccordo G1 1/4 coppia di serraggio massima 80 Nm. Raccordo G1 1/2 coppia di serraggio massima 90 Nm. Consigliamo di richiedere conferma al fornitore del raccordo.

Tightening torques for G3/4 fitting: 60 Nm. Tightening torques for G1 fitting: 70 Nm. Tightening torques for G1 1/4 fitting: 80 Nm. Tightening torques for G1 1/2 fitting: 90 Nm. Please check with the fittings suppliers.

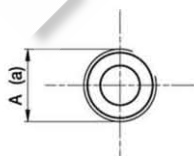

FC

TIPO TYPE	ASPIRAZIONE INLET	MANDATA OUTLET
	A	a
ALP3...30 ÷ ALP3...33	Rc3/4	Rc3/4
ALP3...40 ÷ ALP3...60	Rc1	Rc3/4
ALP3...66 ÷ ALP3...94	Rc1 1/4	Rc1
ALP3...110 ÷ ALP3...135	Rc1 1/2	Rc1 1/4

Raccordo Rc3/4 coppia di serraggio massima 60 Nm. Raccordo Rc1 coppia di serraggio massima 70 Nm. Raccordo Rc1 1/4 coppia di serraggio massima 80 Nm. Raccordo Rc1 1/2 coppia di serraggio massima 90 Nm. Consigliamo di richiedere conferma al fornitore del raccordo.

Tightening torques for Rc3/4 fitting: 60 Nm. Tightening torques for Rc1 fitting: 70 Nm. Tightening torques for Rc1 1/4 fitting: 80 Nm. Tightening torques for Rc1 1/2 fitting: 90 Nm. Please check with the fittings suppliers.

ALP3

PORTE / PORTS

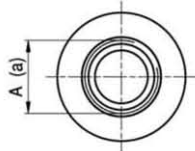

STANDARD SAE J1926/1

FA

TIPO TYPE	ASPIRAZIONE INLET	MANDATA OUTLET
	A	a
ALP3...30 ÷ ALP3...50	1 5/16-12 UNF	1 1/16-12 UNF
ALP3...60 ÷ ALP3...80	1 5/8-12 UNF	1 1/16-12 UNF
ALP3...94 ÷ ALP3...135	1 7/8-12 UNF	1 5/16-12 UNF

Raccordo 1 1/16-12 UNF coppia di serraggio massima 70 Nm. Raccordo 1 5/16-12 UNF coppia di serraggio massima 80 Nm. Raccordo 1 5/8-12 UNF coppia di serraggio massima 80 Nm. Raccordo 1 7/8-12 UNF coppia di serraggio massima 80 Nm. Consigliamo di richiedere conferma al fornitore del raccordo.

Tightening torques for 1 1/16-12 UNF fitting: 70 Nm. Tightening torques for 1 5/16-12 UNF fitting: 80 Nm. Tightening torques for 1 5/8-12 UNF fitting: 80 Nm. Tightening torques for 1 7/8-12 UNF fitting: 80 Nm. Please check with the fittings suppliers.

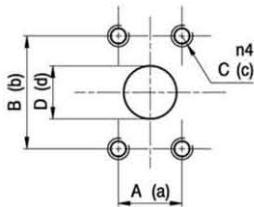

A

TIPO TYPE	ASPIRAZIONE INLET				MANDATA OUTLET			
	A	B	C	D	a	b	c	d
ALP3...30 ÷ ALP3...80	26,19	52,37	3/8-16 UNC	27	22,23	47,63	3/8-16 UNC	19
ALP3...94 ÷ ALP3...135	30,2	58,7	7/16-14 UNC	33	26,19	52,37	3/8-16 UNC	27

I valori delle coppie di serraggio delle viti presenti nel kit raccordo sono indicate a pag 57 (capitolo accessori).

Tightening torques of the fittings screws are specified on page 57 (accessories section).

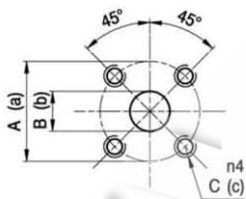

D

TIPO TYPE	ASPIRAZIONE INLET			MANDATA OUTLET		
	A	B	C	a	b	c
ALP3...30 ÷ ALP3...80	55	27	M8	55	19	M8

I valori delle coppie di serraggio delle viti presenti nel kit raccordo sono indicate a pag 57 (capitolo accessori).

Tightening torques of the fittings screws are specified on page 57 (accessories section).

ALP3 CURVE CARATTERISTICHE

ALP3 PERFORMANCE CURVES

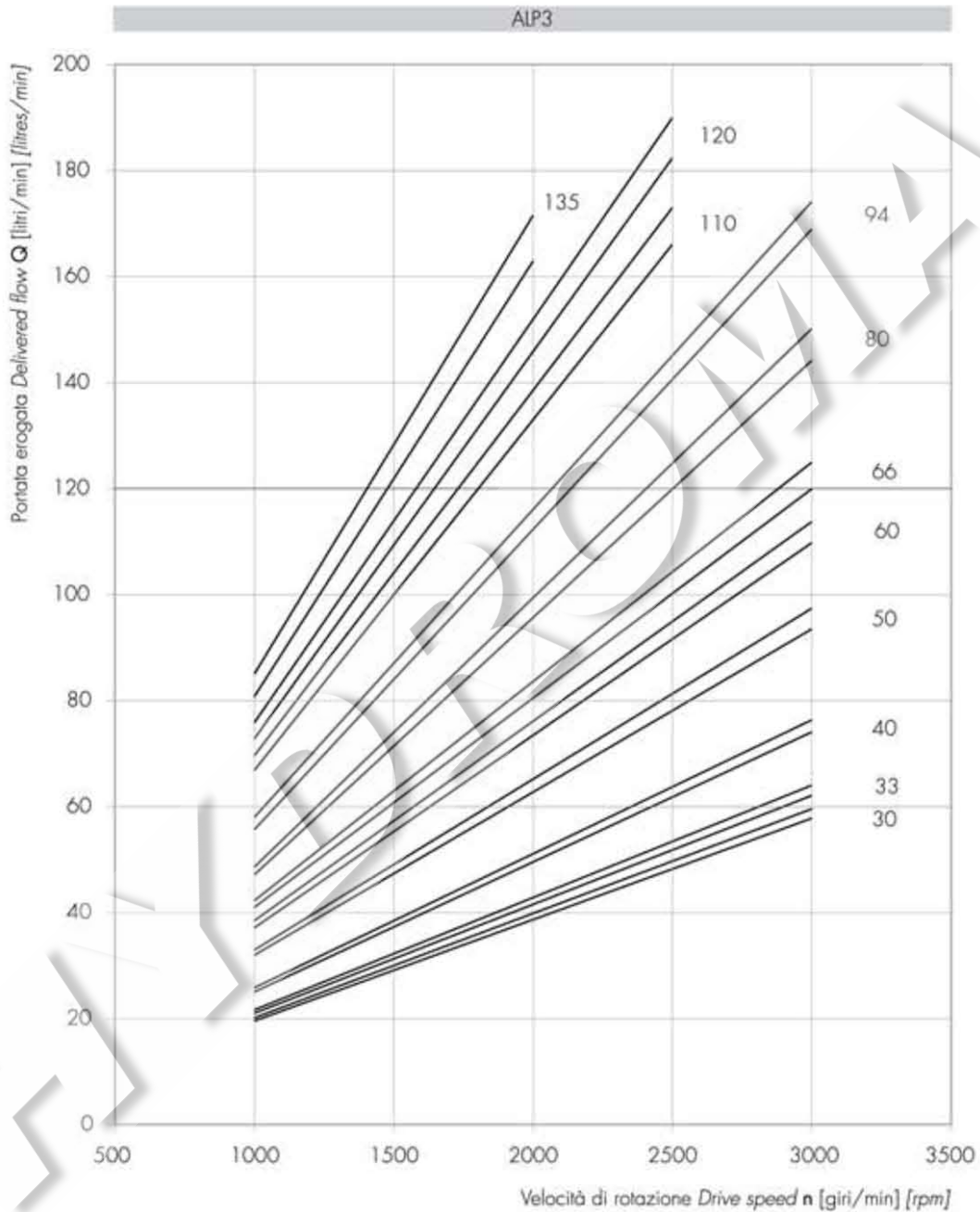

Le curve sono state ottenute alla temperatura di 50°C, utilizzando olio con viscosità 30 cSt alle pressioni sotto riportate.

Each curve has been obtained at 50°C, using oil with viscosity 30 cSt at these pressure.

30 |
33 |— 25-250 bar
40 |

80 |— 25-220 bar
94 |— 25-200 bar

110 |— 25-180 bar
120 |— 25-170 bar
135 |— 25-150 bar

50 |
60 |— 25-240 bar
66 |

Potenza assorbita Absorbed power P [kW]
 Momento torcente assorbito Absorbed torque M [Nm]
 Velocità di rotazione Drive speed n [giri/min] [rpm]

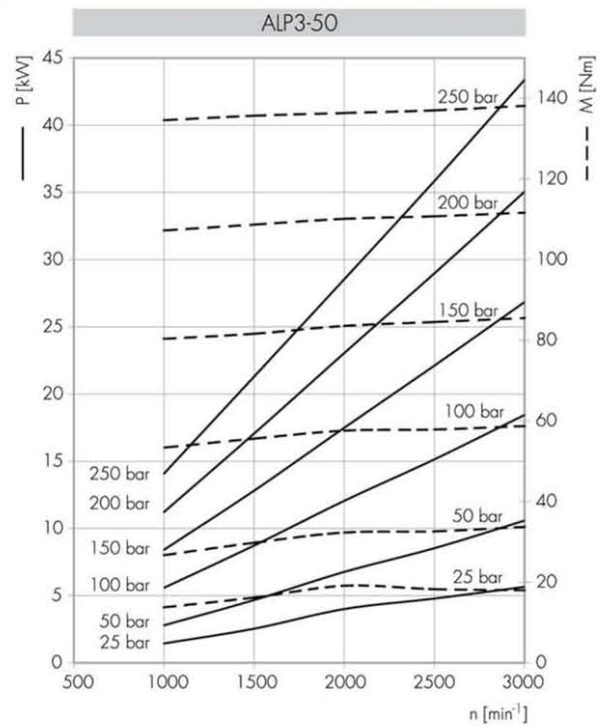
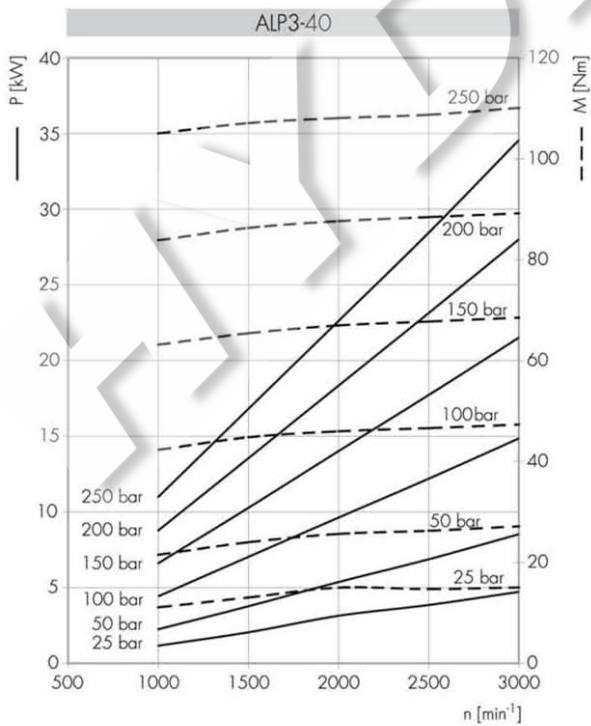
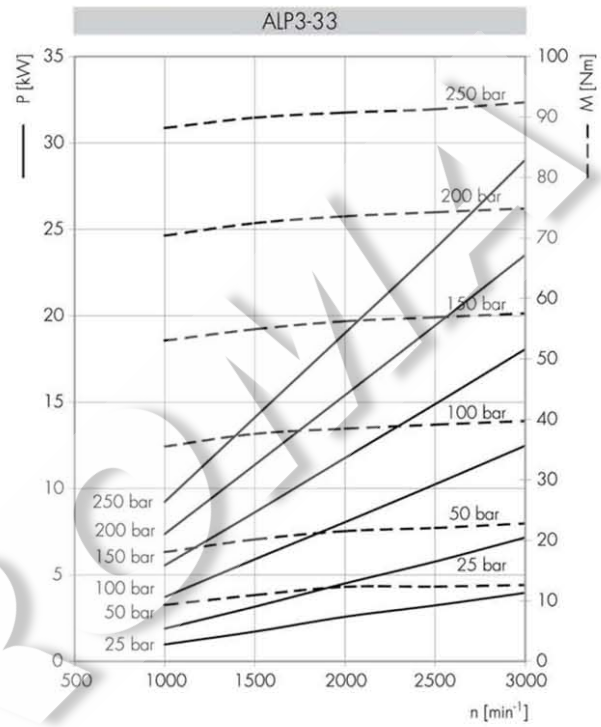
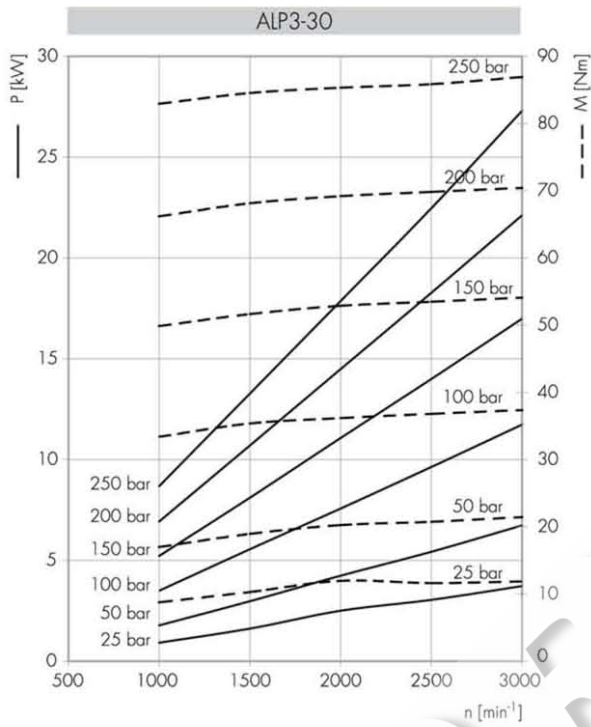

Potenza assorbita Absorbed power P [kW]
 Momento torcente assorbito Absorbed torque M [Nm]
 Velocità di rotazione Drive speed n [giri/min] [rpm]

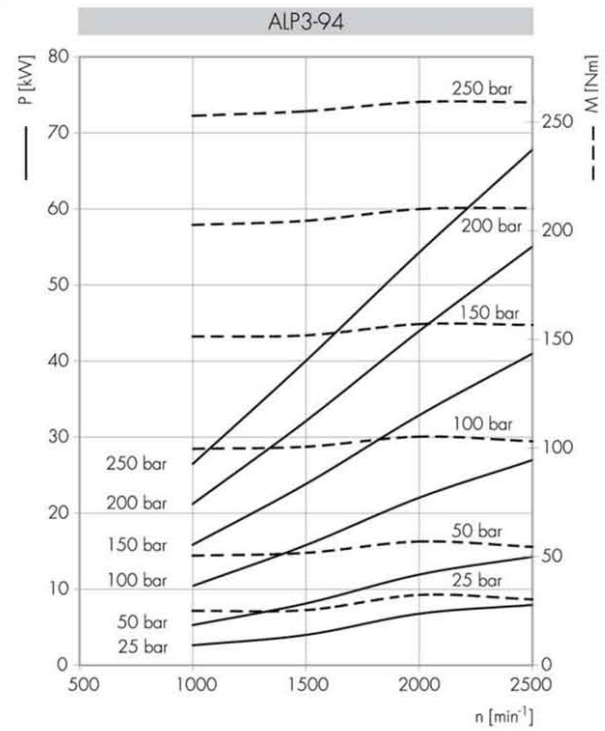
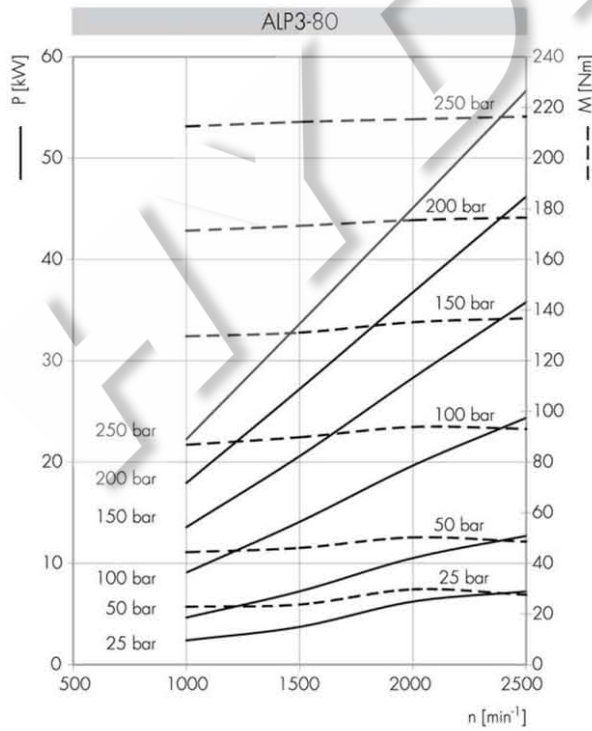
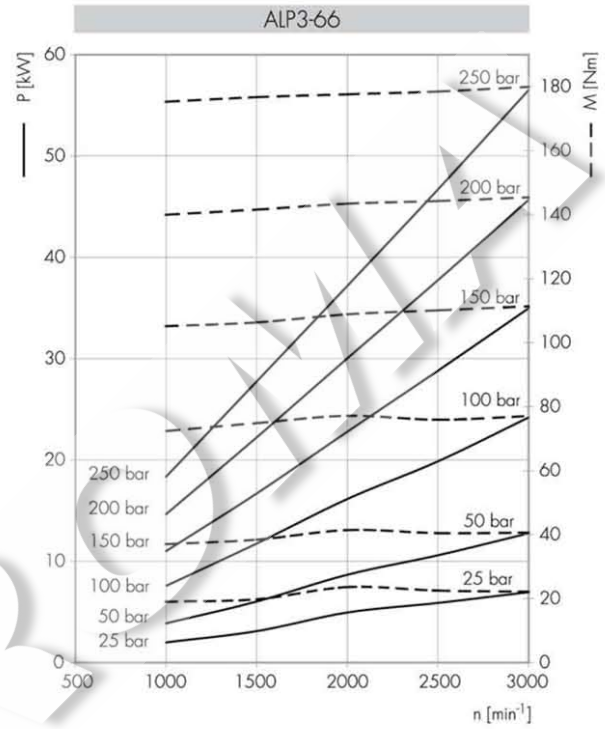
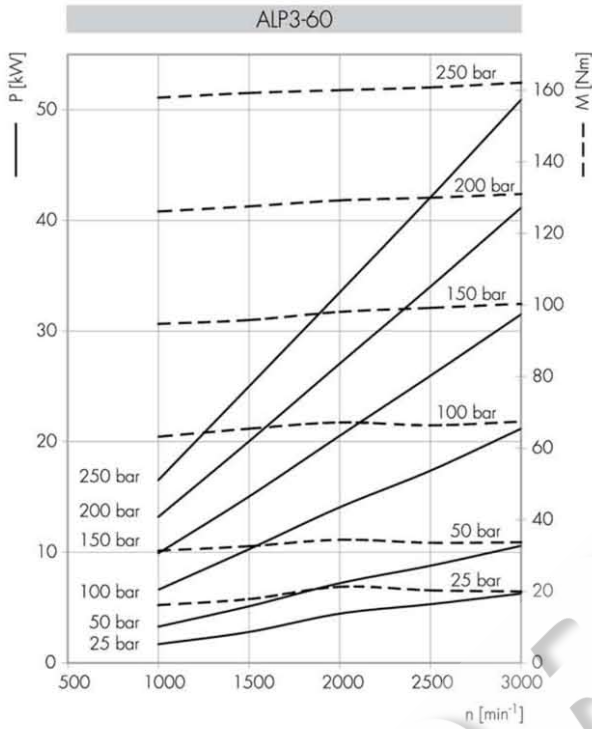

Potenza assorbita Absorbed power P [kW]
 Momento torcente assorbito Absorbed torque M [Nm]
 Velocità di rotazione Drive speed n [giri/min] [rpm]

