

Part number:

41 600/113 ED

DSH*

LEVER OPERATED DIRECTIONAL CONTROL VALVE



MOUNTING SURFACES

DSH3 ISO 4401-03 (CETOP 03)

DSH5 ISO 4401-05 (CETOP 05)

p max (see performances table)

Q nom (see performances table)

OPERATING PRINCIPLE

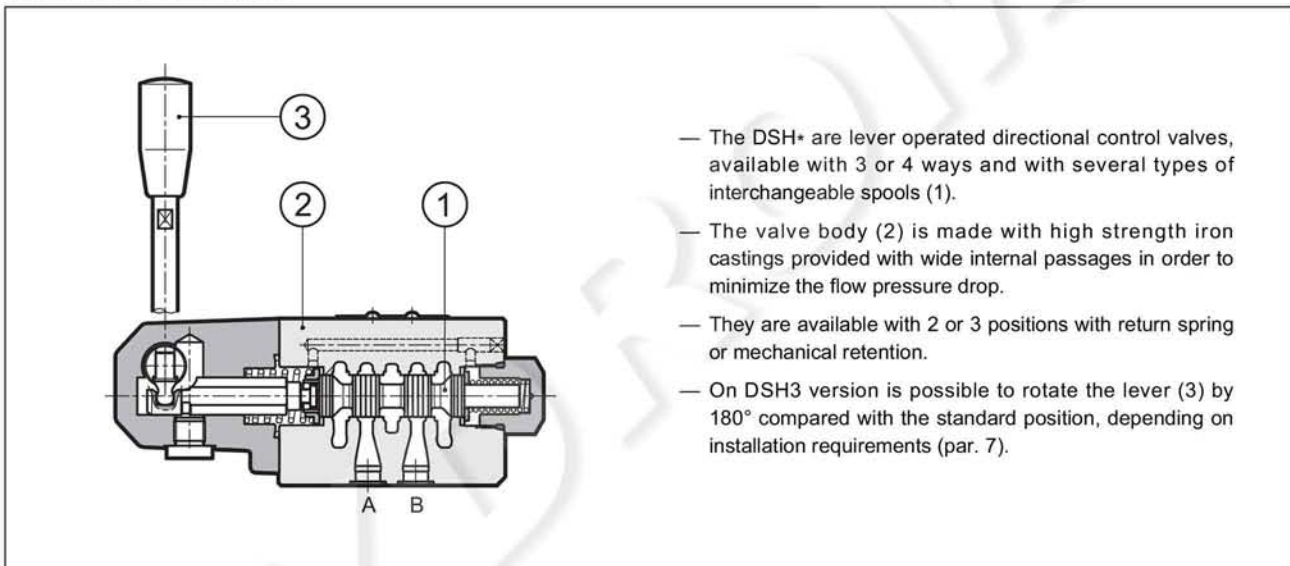

- The DSH+ are lever operated directional control valves, available with 3 or 4 ways and with several types of interchangeable spools (1).
- The valve body (2) is made with high strength iron castings provided with wide internal passages in order to minimize the flow pressure drop.
- They are available with 2 or 3 positions with return spring or mechanical retention.
- On DSH3 version is possible to rotate the lever (3) by 180° compared with the standard position, depending on installation requirements (par. 7).

PERFORMANCES (with mineral oil of viscosity of 36 cSt at 50°C)

		DSH3	DSH5
Maximum working pressure:	- P - A - B ports	350	320
	- T port	210	160
Nominal flow rate	l/min	75	150
Ambient temperature range	°C	-20 / +50	
Fluid temperature range	°C	-20 / +80	
Fluid viscosity range	cSt	10 ÷ 400	
Fluid contamination degree		according to ISO 4406:1999 class 20/18/15	
Recommended viscosity	cSt	25	
Mass	kg	2.1	4.2

1 - IDENTIFICATION CODE

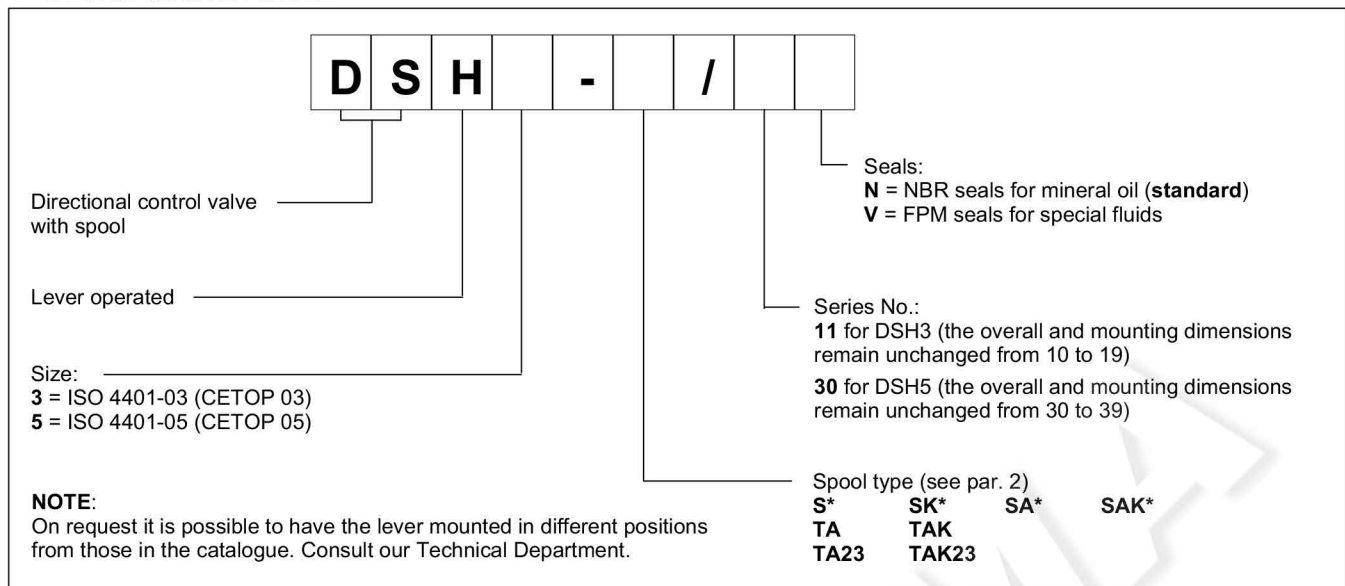

2 - SPOOL TYPE

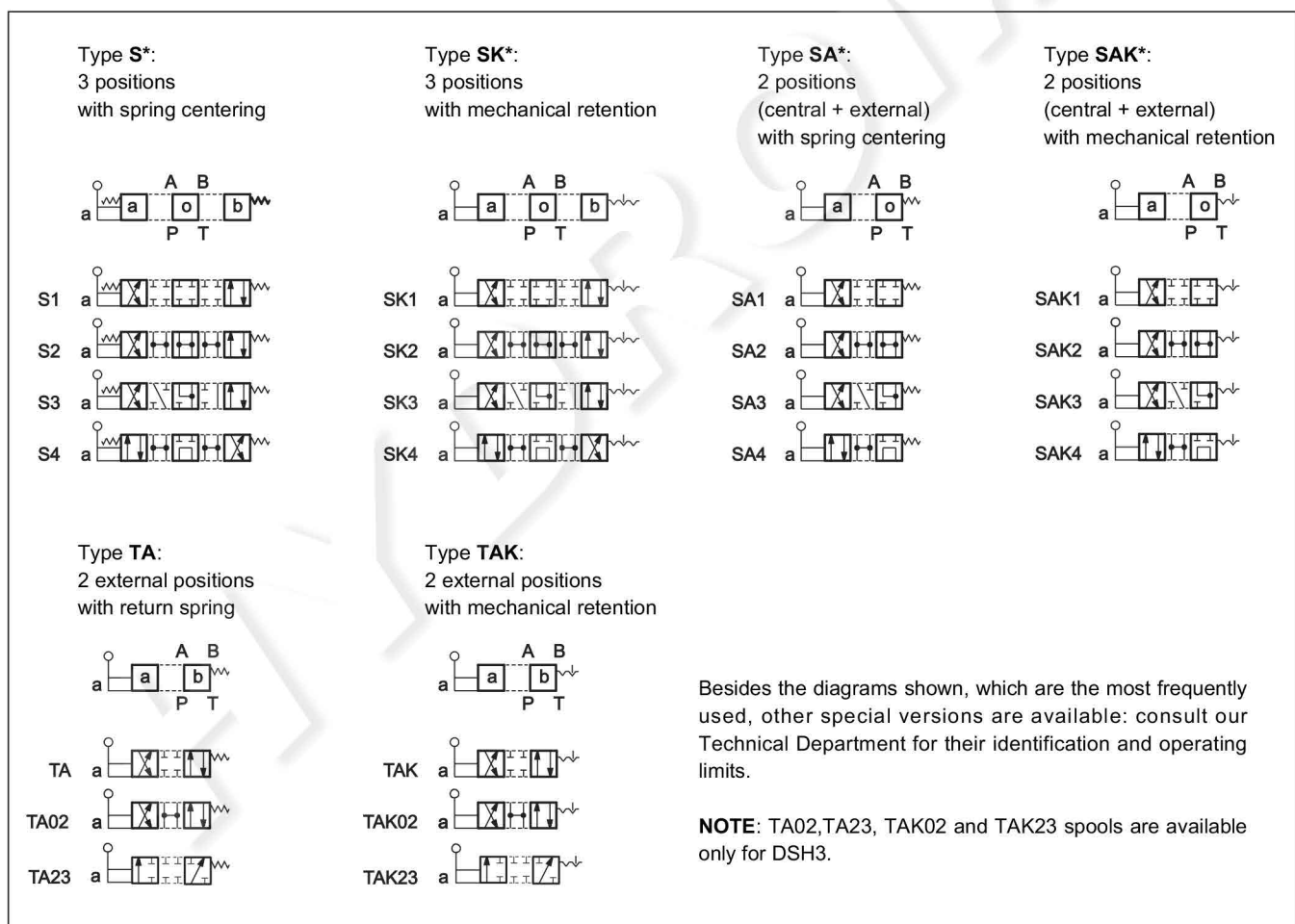

3 - HYDRAULIC FLUIDS

Use mineral oil-based hydraulic fluids HL or HM type, according to ISO 6743-4. For these fluids, use NBR seals (code N). For fluids HFDR type (phosphate esters) use FPM seals (code V). For the use of other fluid types such as HFA, HFB, HFC, please consult our technical department.

Using fluids at temperatures higher than 80 °C causes a faster degradation of the fluid and of the seals characteristics. The fluid must be preserved in its physical and chemical characteristics.

4 - PRESSURE DROPS Δp -Q (values obtained with viscosity 36 cSt at 50 °C)

4.1 - DSH3

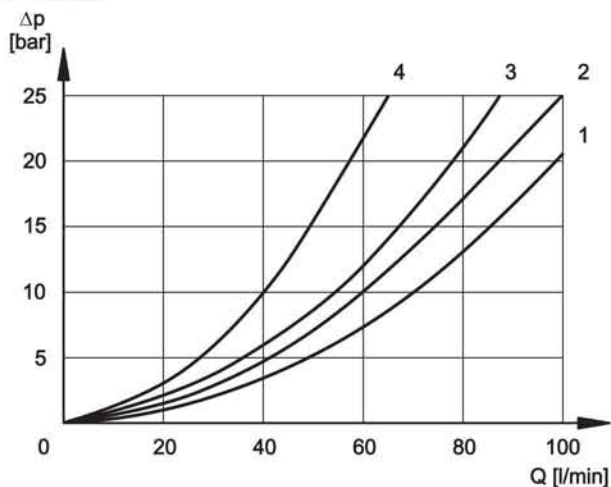

VALVE IN ENERGIZED POSITION

SPOOL TYPE	FLOW DIRECTION			
	P→A	P→B	A→T	B→T
CURVES ON GRAPH				
S1, SA1, SAK1	2	2	3	3
S2, SA2, SAK2	1	1	3	3
S3, SA3, SAK3	3	3	1	1
S4, SA4, SAK4	4	4	4	4
TA, TAK	3	3	3	3
TA02, TAK02	2	2	2	2
TA23, TAK23	3	3		

VALVE IN DE-ENERGIZED POSITION

SPOOL TYPE	FLOW DIRECTION				
	P→A	P→B	A→T	B→T	P→T
CURVES ON GRAPH					
S2, SA2, SAK2					2
S3, SA3, SAK3			3	3	
S4, SA4, SAK4					3

4.2 - DSH5

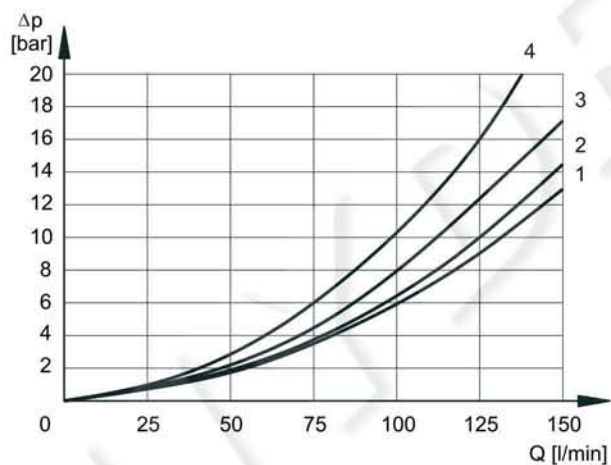

VALVE IN ENERGIZED POSITION

SPOOL TYPE	FLOW DIRECTION			
	P→A	P→B	A→T	B→T
CURVES ON GRAPH				
S1, SK1	2	2	1	1
S2, SK2	3	3	1	1
S3, SK3	3	3	2	2
S4, SK4	1	1	2	2
TA, TAK	3	3	2	2

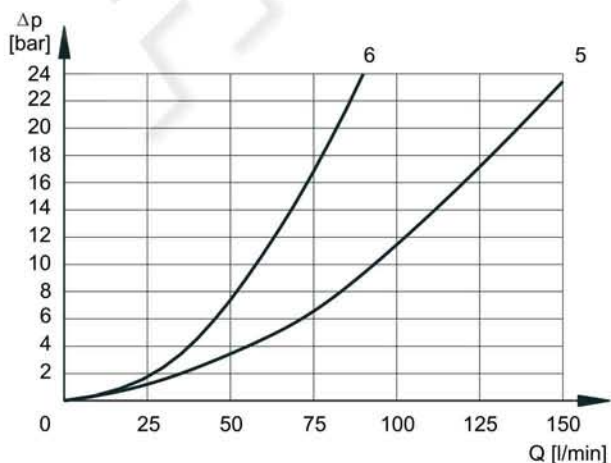

VALVE IN DE-ENERGIZED POSITION

SPOOL TYPE	FLOW DIRECTION				
	P→A	P→B	A→T	B→T	P→T
CURVES ON GRAPH					
S2, SK2					5
S3, SK3			6	6	
S4, SK4					5

5 - OPERATING LIMITS

The curves define the flow rate operating fields according to the valve pressure of the different versions.

The values have been obtained according to ISO 6403 norm, with mineral oil viscosity 36 cSt at 50 °C and filtration ISO 4406:1999 class 18/16/13.

5.1 - DSH3

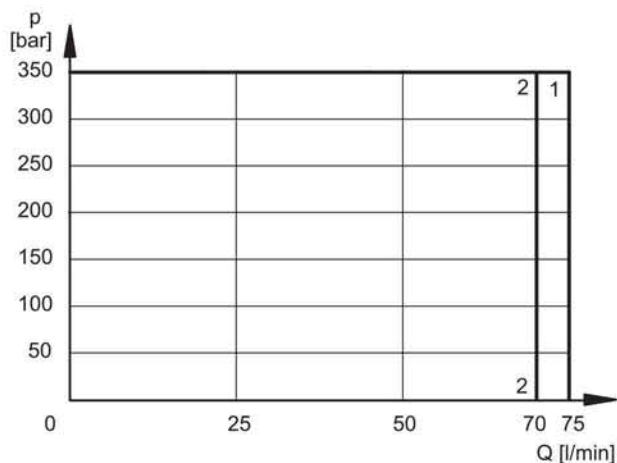

SPOOL TYPE	CURVE	
	P→A	P→B
S1, SK1, SA1, SAK1	1	1
S2, SK2, SA2, SAK2	1	1
S3, SK3, SA3, SAK3	1	1
S4, SK4, SA4, SAK4	2	2

SPOOL TYPE	CURVE	
	P→A	P→B
TA, TAK	1	1
TA02, TAK02	1	1
TA23, TAK23	1	1

5.2 - DSH5

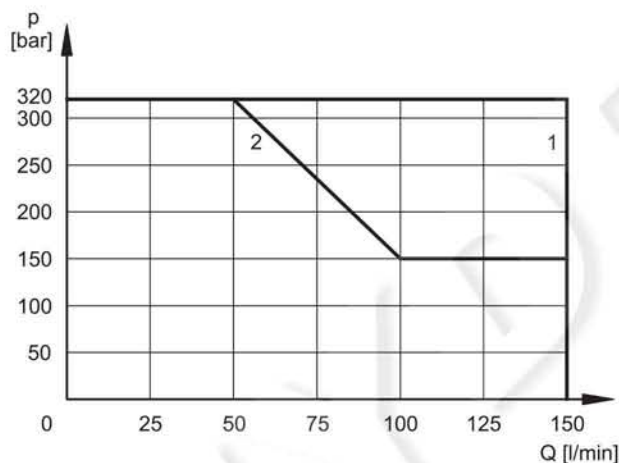

SPOOL TYPE	CURVE	
	P→A	P→B
S1, SK1, SA1, SAK1	1	1
S2, SK2, SA2, SAK2	1	1
S3, SK3, SA3, SAK3	1	1
S4, SK4, SA4, SAK4	2	2

SPOOL TYPE	CURVE	
	P→A	P→B
TA, TAK	1	1

NOTE: Values in the graphs are relevant to the standard valve. The operating limits can be considerably reduced if a 4-way valve is used with port A or B plugged.

6 - INSTALLATION

Configurations with centering and return springs can be mounted in any position; valves with mechanical detent must be mounted with the longitudinal axis horizontal.

Valve fixing is by means of screws or tie rods, with the valve mounted on a lapped surface, with values of planarity and smoothness that are equal to or better than those indicated in the drawing. If the minimum values of planarity and/or smoothness are not met, fluid leakage between valve and mounting surface can easily occur.

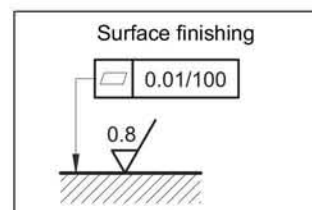

7 - OVERALL AND MOUNTING DIMENSIONS DSH3

DSH3 - S*
DSH3 - SK*

dimensions in mm

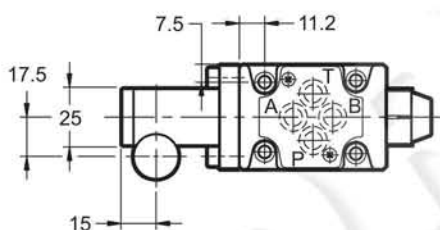
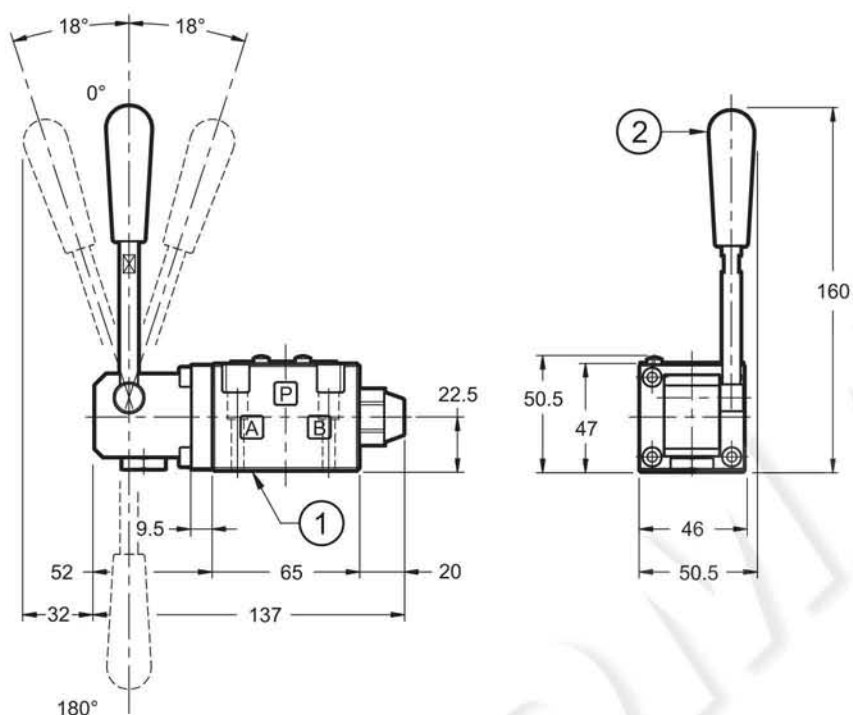

DSH3 MOUNTING SURFACE

ISO 4401-03-02-0-05
(CETOP 4.2-4-03-350)

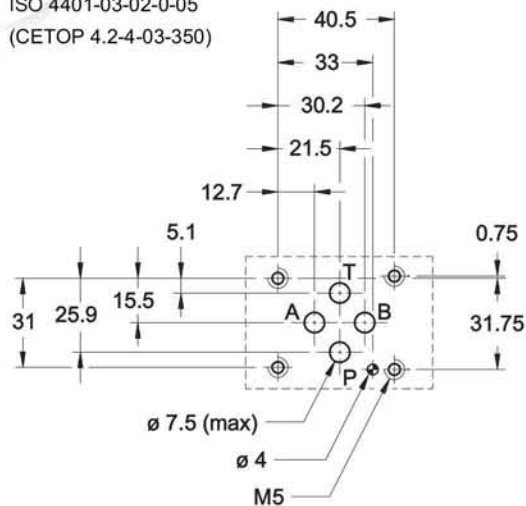

DSH3-TA
DSH3-TAK

DSH3-TA23
DSH3-TAK23

DSH3-SA*
DSH3-SAK*

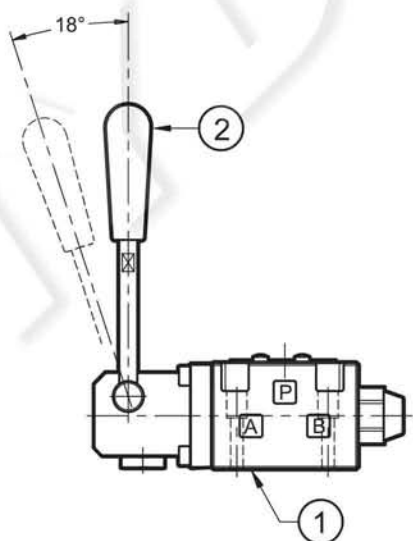

1	Mounting surface with sealing rings: N. 4 OR type 2037 (9.25x1.78) - 90 Shore
2	Hand lever (NOTE)

Valve fastening:	N. 4 SHC screws M5x30 ISO 4762
Tightening torque:	5 Nm (bolts A 8.8)
Threads of mounting holes:	M5x10

NOTE: The valve is supplied with the hand lever oriented in a perpendicular position with respect to the mounting surface (as indicated in the above drawing). For installation needs the hand lever can be oriented by the user directly at 180° to the standard position, simply by unscrewing the lever and re-screwing it in the desired position.

8 - OVERALL AND MOUNTING DIMENSIONS DSH5

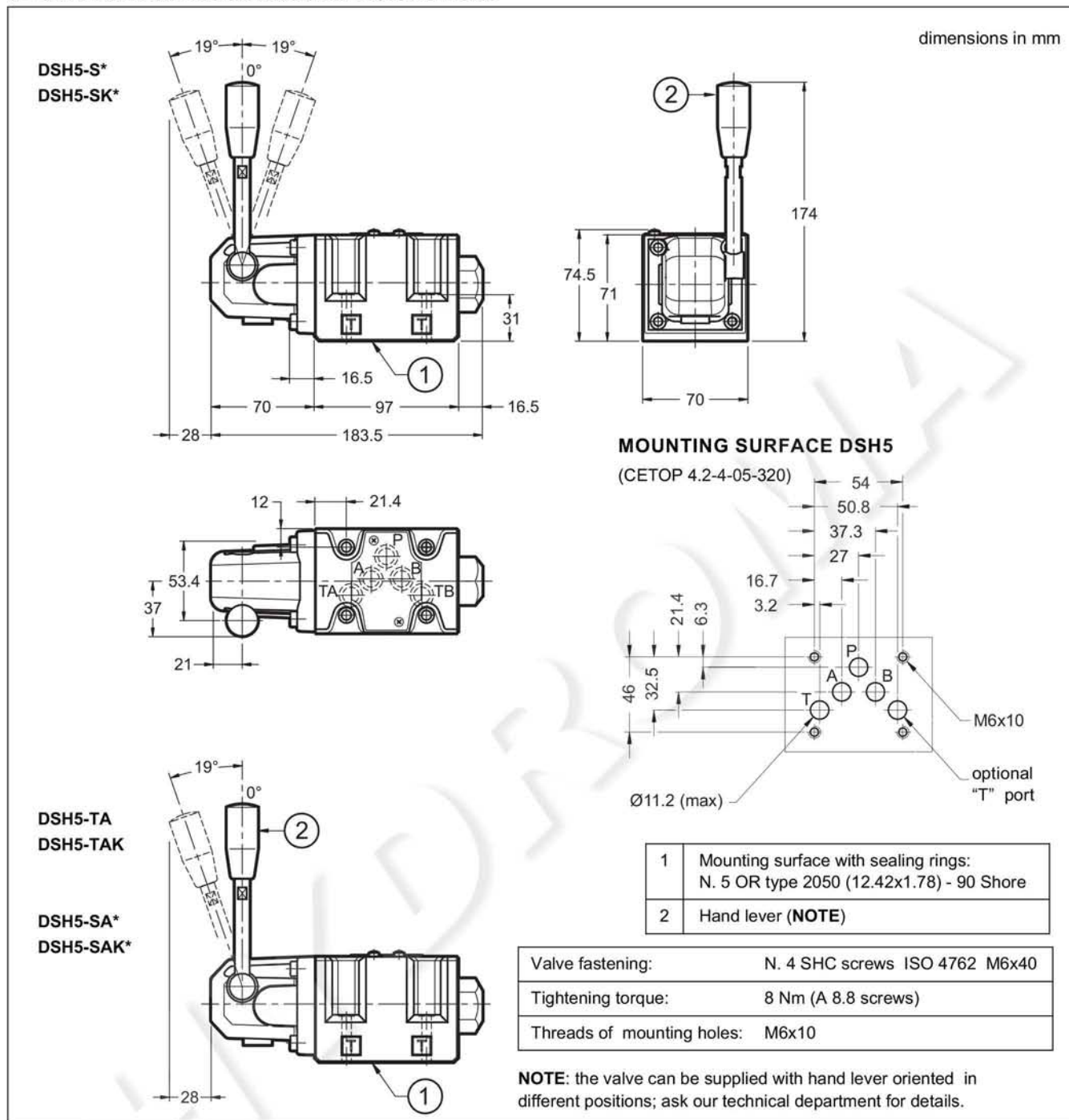

9 - SUBPLATES (See catalogue 51 000)

	DSH3	DSH5
Type with rear ports	PMMD-AI3G	PMD4-AI4G - 3/4" BSP threaded
Type with side ports	PMMD-AL3G	PMD4-AL4G - 1/2" BSP threaded
P, T, A and B threads	3/8" BSP	