

Part number:

HYDROMA

HYDRAULICKÉ SYSTÉMY

**HIDROMA
SYSTEMS**

UKŁADY HYDRAULICZNE

HYDROMA

ГИДРАВЛИЧЕСКИЕ СИСТЕМЫ

FPG-MDS

PRESSURE FILTERS

MATERIALS

Head: Aluminium alloy

Bowl: Steel

Bypass valve: Steel

Seals: NBR Nitrile (FKM - on request fluoroelastomer)

Indicator housing: Brass

PRESSURE

Max working: 5 MPa (50 bar)

Collapse, differential for the filter element (ISO 2941):

1 MPa (10 bar)

BYPASS VALVE

Setting: 350 kPa (3,5 bar) $\pm 10\%$

WORKING TEMPERATURE

From -25° to $+110^{\circ}$ C

COMPATIBILITY (ISO 2943)

Full with fluids: HH-HL-HM-HV-HTG

(according to ISO 6743/4)

For fluids different than the above mentioned,
please contact our Customer Service.

HYDRAULIC DIAGRAM

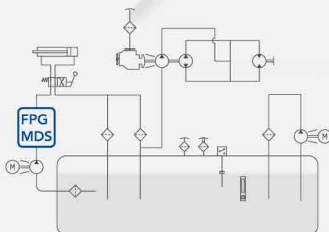

Is this datasheet the latest release? Please check on our website.



FPG

PRESSURE FILTERS

ORDERING AND OPTION CHART

F	P	G	COMPLETE FILTER FAMILY						FILTER ELEMENT FAMILY	E	P	G
			SIZE & LENGTH	20	21	22	31		SIZE & LENGTH			
		B	PORT TYPE									
			B = BSP thread	B	B	B	B					
			PORT SIZE									
			06 = 3/4"	06	06	06	-					
			08 = 1"	08	08	08	-					
			10 = 1" 1/4	-	-	-	10					
			12 = 1" 1/2	-	-	-	12					
			BYPASS VALVE									
			W = without	W	W	W	W					
			D = 350 kPa (3,5 bar)	D	D	D	D					
			SEALS						SEALS			
			N = NBR Nitrile	N	N	N	N					
			F = FKM Fluoroelastomer	F	F	F	F					
			FILTER MEDIA						FILTER MEDIA			
			FA = fibreglass 5 µm(c) β>1.000	FA	FA	FA	FA					
			FB = fibreglass 7 µm(c) β>1.000	FB	FB	FB	FB					
			FC = fibreglass 12 µm(c) β>1.000	FC	FC	FC	FC					
			FS = fibreglass 16 µm(c) β>1.000	FS	FS	FS	FS					
			FD = fibreglass 21 µm(c) β>1.000	FD	FD	FD	FD					
			FE = fibreglass 30 µm(c) β>1.000	FE	FE	FE	FE					
			CC = impregnated cellulose 10 µm β>2	CC	CC	CC	CC					
			CD = impregnated cellulose 25 µm β>2	CD	CD	CD	CD					
			MC = metal wire mesh 10 µm	MC	MC	MC	MC					
			MD = metal wire mesh 30 µm	MD	MD	MD	MD					
			ME = metal wire mesh 60 µm	ME	ME	ME	ME					
			MF = metal wire mesh 90 µm	MF	MF	MF	MF					
			CLOGGING INDICATOR**									
			00 = no indicator port	00	00	00	00					
			03 = port, plugged	03	03	03	03					
			5D = visual differential 250 kPa (2,5 bar)	5D	5D	5D	5D					
			6D = electrical differential 250 kPa (2,5 bar)	6D	6D	6D	6D					
			7D = indicator 6D with LED	7D	7D	7D	7D					
			T6 = elect. diff. 250 kPa (2,5 bar) with thermostat 30°C	T6	T6	T6	T6					
			ACCESSORIES									
			W = No indicator port	W	W	W	W					
			A = Indicator port side A (see dwg)	A	A	A	A					
			B = Indicator port side B (see dwg)	B	B	B	B					
			C = Indicator port side C (see dwg)	C	C	C	C					
		X	ACCESSORIES									
			X = no accessory available	X	X	X	X					

SPARE PARTS ELEMENTS

FILTER HOUSING													FILTER ELEMENT				CLOGGING INDICATOR				
																					
B	P	G											E	P	G						

MDS

PRESSURE FILTERS

ORDERING AND OPTION CHART

M	D	S	COMPLETE FILTER FAMILY					FILTER ELEMENT FAMILY	C	D	S
			SIZE & LENGTH	205	210	220	310	SIZE & LENGTH			
			FILTER MEDIA					FILTER MEDIA			
			FT = fibreglass 5 µm(c) β>1.000	FT	FT	FT	FT				
			FC = fibreglass 7 µm(c) β>1.000	FC	FC	FC	FC				
			FD = fibreglass 12 µm(c) β>1.000	FD	FD	FD	FD				
			FS = fibreglass 16 µm(c) β>1.000	FS	FS	FS	FS				
			FV = fibreglass 21 µm(c) β>1.000	FV	FV	FV	FV				
			CD = impregnated cellulose 10 µm β>2	CD	CD	CD	CD				
			CV = impregnated cellulose 25 µm β>2	CV	CV	CV	CV				
			MV = metal wire mesh 30 µm	MV	MV	MV	MV				
			MS = metal wire mesh 60 µm	MS	MS	MS	MS				
			MN = metal wire mesh 90 µm	MN	MN	MN	MN				
			SEALS					SEALS			
			1 = NBR Nitrile	1	1	1	1				
			2 = FKM Fluoroelastomer	2	2	2	2				
			BYPASS VALVE								
			S = without	S	S	S	S				
			D = 350 kPa (3,5 bar)	D	D	D	D				
			PORT TYPE								
			B = BSP thread	B	B	B	B				
			PORT SIZE								
			4 = 3/4"	4	4	4	-				
			5 = 1"	5	5	5	-				
			6 = 1" 1/4	-	-	-	6				
			7 = 1" 1/2	-	-	-	7				
			CLOGGING INDICATOR**								
			00 = no indicator port	00	00	00	00				
			03 = port, plugged	03	03	03	03				
			5D = visual differential 250 kPa (2,5 bar)	5D	5D	5D	5D				
			6D = electrical differential 250 kPa (2,5 bar)	6D	6D	6D	6D				
			7D = indicator 6D with LED	7D	7D	7D	7D				
			T6 = elect. diff. 250 kPa (2,5 bar) with thermostat 30°C	T6	T6	T6	T6				
			ACCESSORIES								
			S = No indicator port	S	S	S	S				
			A = Indicator port side A (see dwg)	A	A	A	A				
			B = Indicator port side A (see dwg)	B	B	B	B				
			C = Indicator port side A (see dwg)	C	C	C	C				
		X	ACCESSORIES								
			X = no accessory available	X	X	X	X				

SPARE SEAL KIT

	NBR	FKM
FPG20 MDS205	521.0117.2	521.0118.2
FPG21 MDS210	521.0117.2	521.0118.2
FPG22 MDS220	521.0117.2	521.0118.2
FPG31 MDS310	521.0119.2	521.0120.2

NOTES

** When the filter is ordered with FKM seals, the first digit of the indicator code is a letter
(please see Clogging Indicator Chapter for further details)

FPG-MDS

PRESSURE FILTERS

INSTALLATION DRAWING

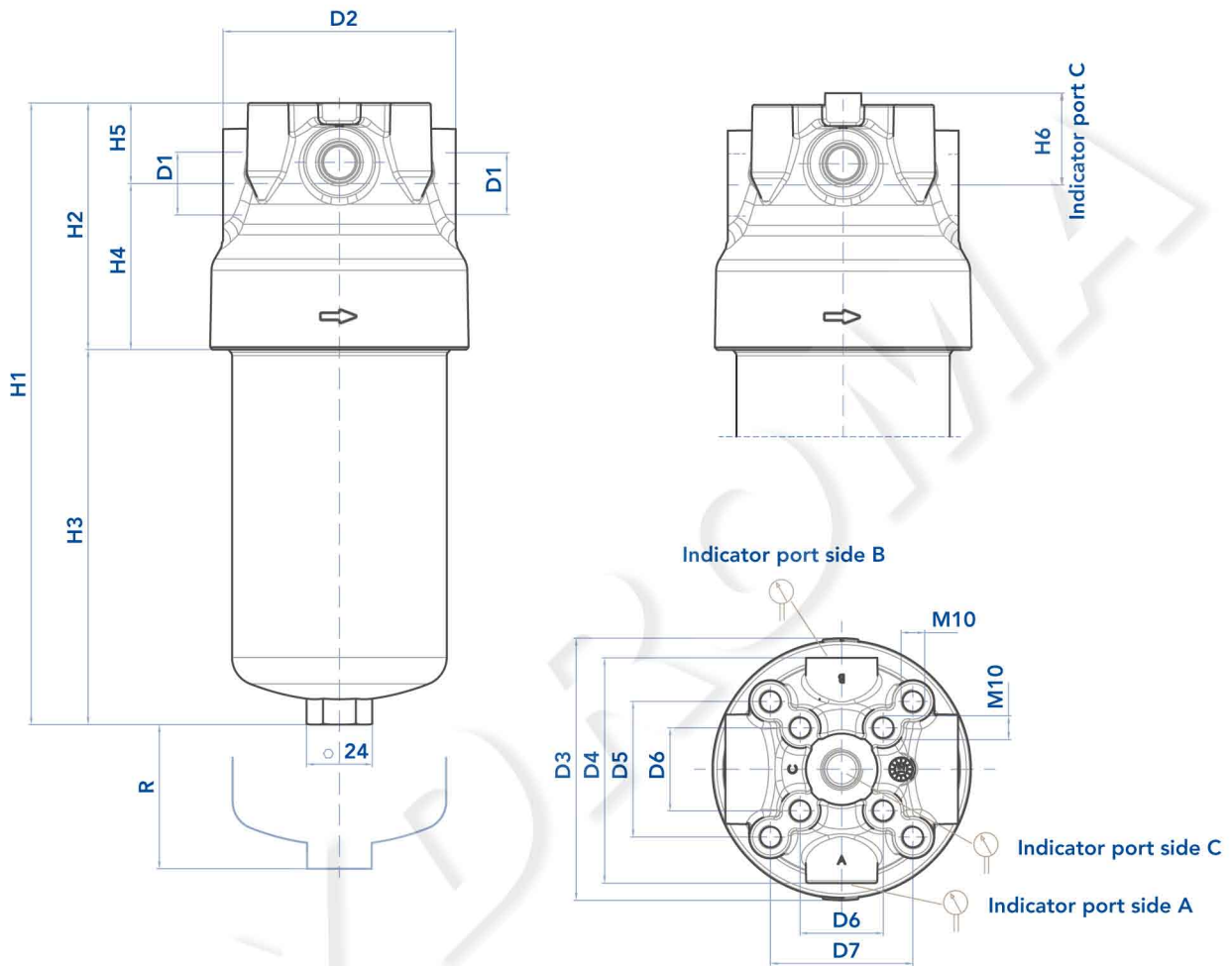

FILTER HOUSING

	D1	D2	D3	D4	D5	D6	D7	H1	H2	H3	H4	H5*	H6*	R	Kg
FPG20 MDS205	3/4" - 1"	98	110,5	95	57	35	60	202	104	98	70	34	39	70	2,00
FPG21 MDS210	3/4" - 1"	98	110,5	95	57	35	60	262	104	158	70	34	39	70	2,25
FPG22 MDS220	3/4" - 1"	98	110,5	95	57	35	60	342	104	238	70	34	39	70	2,80
FPG31 MDS31	1"1/4 - 1"1/2	122	126	114	70	48	70	341	121	220	77	39	44	70	3,50

* with clogging indicatro option W, A and B, please condider H5; with clogging indicator option C, please consider H6.

MAINTENANCE

The best time to change your filter element is just before it reaches its maximum dirt-holding capacity. For this reason, we recommend to monitor the pressure of the hydraulic oil flowing through the filter with a clogging indicator. When it is time to change the filter element, switch off the system before opening the filter housing and make sure there is no pressure in the filter. Unscrew the bowl and remove the dirty filter element. Replace it with an original UFI element, verifying the

part number on the filter label or on the catalogue. Clean the bowl; check the gaskets conditions and replace if necessary. Insert the clean element into his seat, handling with care and cleanliness. Screw the housing until it stops, with a tightening torque of 50 Nm +5/0. We recommend the stocking of a spare UFI filter element for timely replacement when required.

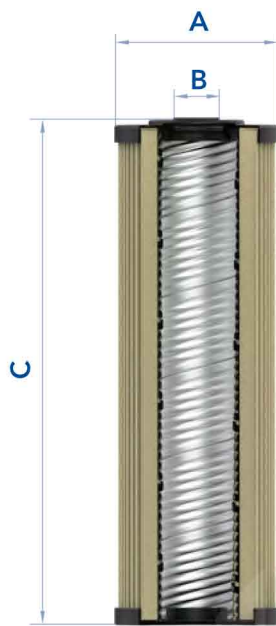

FILTER ELEMENT

	A	B	C	Kg	AREA (cm ²)		
					Media F+	Media F+	Media M+
EPG20 CDS205	78	30	100	0,20	1.300	1.500	1.000
EPG21 CDS210	78	30	160	0,30	2.200	2.550	1.700
EPG22 CDS220	78	30	240	0,45	3.300	3.900	2.600
EPG31 CDS310	92	40	215	0,45	4.700	5.100	3.500

The used filter elements cannot be cleaned and are classified as "Dangerous waste material". They must be disposed according to local laws by authorized Companies. Verify that the Company you choose has the expertise and authorization to dispose this type of waste material.

FPG-MDS

PRESSURE FILTERS

PRESSURE DROP CURVES (ΔP)

The “Assembly Pressure Drop (Δp)” is obtained by adding the pressure drop values of the Filter Housing and of the Clean Filter Element corresponding to the considered Flow Rate and it must be

lower than 120 kPa (1,2 bar) and should never exceed 1/3 of the bypass valve setting.

FILTER HOUSING PRESSURE DROP
(mainly depending on the port size)

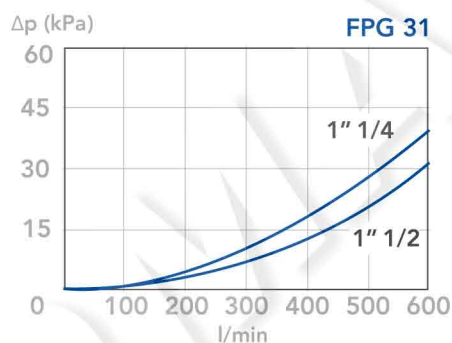
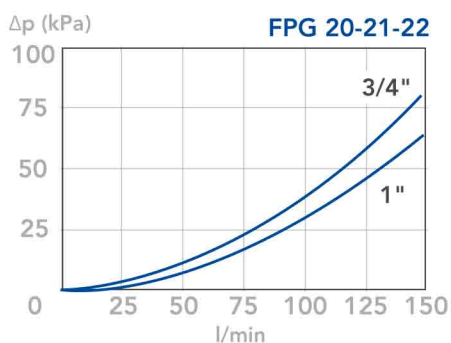

CLEAN FILTER ELEMENT PRESSURE DROP WITH F+ AND C+MEDIA
(depending both on the internal diameter of the element and on the filter media)

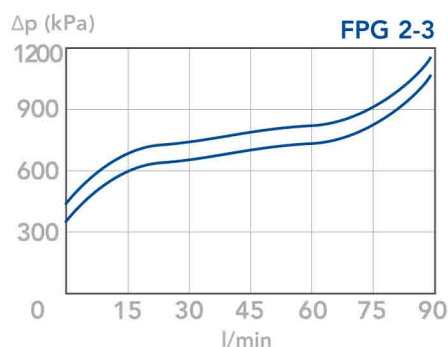
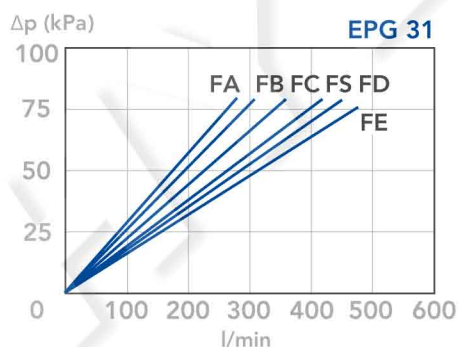
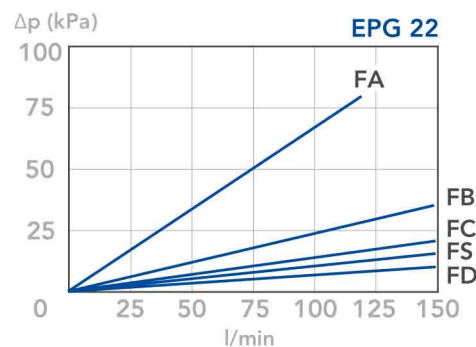
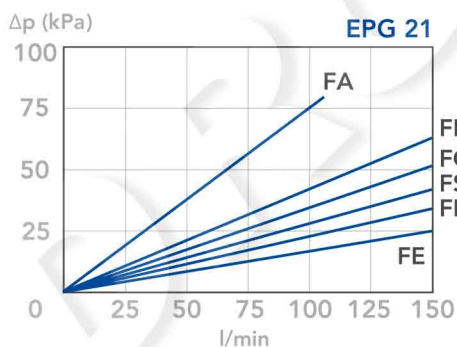
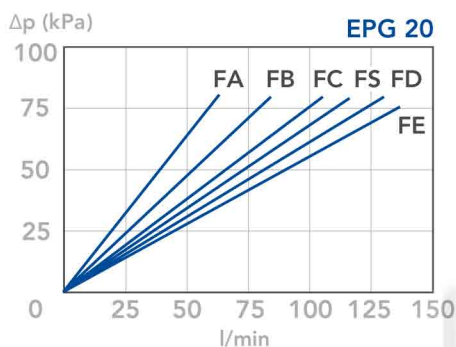

BYPASS VALVE PRESSURE DROP

When selecting the filter size, these curves must be taken into account if it is foreseen that any flow peak is to be absorbed by the bypass valve, it also must be of proper configuration to avoid pressure peaks. The valve pressure drop is directly proportional to fluid specific gravity.

N.B.

All the curves have been obtained with mineral oil having a kinematic viscosity 30 cSt and specific gravity 0,86 kg/dm³; for fluids with different features, please consider the factors described in the first part of this catalogue. All the curves

are obtained from test done at the UFI HYDRAULIC DIVISION Laboratory, according to the specification ISO 3968. In case of discrepancy, please check the contamination level, viscosity and features of the fluid in use.