

Part number:

**HYDROMA**

HYDRAULICKÉ SYSTÉMY

**HIDROMA  
SYSTEMS**

UKŁADY HYDRAULICZNE

**HYDROMA**

ГИДРАВЛИЧЕСКИЕ СИСТЕМЫ

## Flow control valve for piping-system assembly Steel / Stainless Steel

NDV

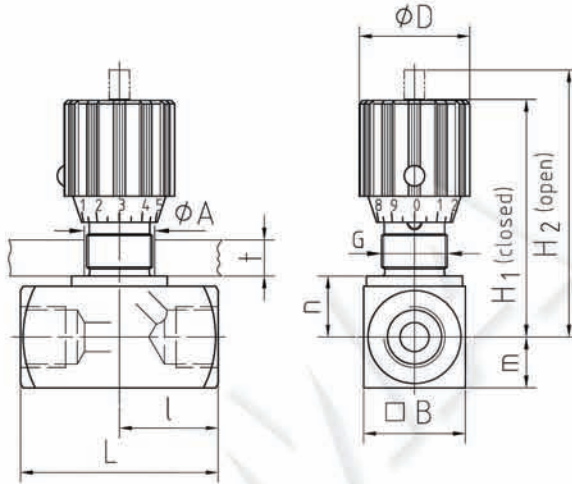

### AVAILABLE SIZES

DN6 - DN40 (1/8" to 2")

### CONNECTIONS

DIN ISO 228 Female thread,  
ANSI B1.20.1 NPT Female thread,  
SAE J 514 ISO/DIS 11926-1 Female thread

### PORTING PATTERN



### ACCESSORIES ON REQUEST

• Panel mounting kit

page 213

### MATERIAL CODE DESCRIPTION

Materials	1A	18	4A	48
Body	Steel	Steel	Stainless Steel	Stainless Steel
O-rings	NBR	FPM	NBR	FPM
Tmin / Tmax	-20°C / 100°C	-20°C / 100°C	-30°C / 100°C	-20°C / 100°C

### GENERAL DIMENSIONS

Type	H <sub>1</sub>	H <sub>2</sub>	m	n	B	l	L	D	A	G	t <sub>max</sub>
NDV-DN6	51	56	8	10	16	19	38	24	13	Pg7	4
NDV-DN8	65	71	12,5	14,5	25	24	48	29	19	Pg11	7
NDV-DN10	68	75	15	17	30	29	58	29	19	Pg11	7
NDV-DN12	82	92	17,5	21	35	34	68	38	23	Pg16	7
NDV-DN16	96	106	22,5	26	45	39	78	38	23	Pg16	7
NDV-DN20	121	134	25	30	50	54	108	49	38	Pg29	10
NDV-DN25	126	139	30	35	60	54	108	49	38	Pg29	10
NDV-DN30	131	144	35	40	70	54	108	49	38	Pg29	10
NDV-DN40	141	154	45	50	90	60	120	49	38	Pg29	10

# Flow control valve for piping-system assembly Steel / Stainless Steel

NDV

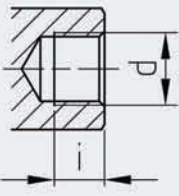
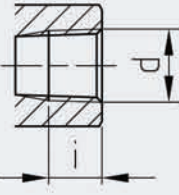
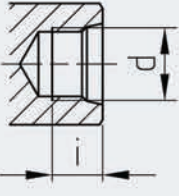
CONNECTION TYPE	DIMENSIONS				ORDER CODE PER MATERIAL COMBINATION				
	Type	i	d	Weight (Kg)	PN [bar]	1A	18	4A	48
<b>DIN ISO 228 FEMALE THREAD</b>  	NDV-DN6-G1/8	9	G1/8	0,12	350	26866*	30689*	33225	30108
	NDV-DN8-G1/4	12	G1/4	0,25	350	23791*	30655*	22084	09952
	NDV-DN10-G3/8	13,5	G3/8	0,40	350	18259*	11673*	20828	20476
	NDV-DN12-G1/2	14,5	G1/2	0,60	350	22827*	09792*	16243	22428
	NDV-DN16-G3/4	17,5	G3/4	1,10	350	28849*	30426*	16244	33051
	NDV-DN20-G1	19,5	G1	2,40	350	30726*	28618*	31240	37628
	NDV-DN25-G1 1/4	21,5	G1 1/4	2,80	350	30853*	31513*	32424	37629
	NDV-DN30-G1 1/2	23,5	G1 1/2	3,50	350	29461*	31639*	29724	37630
	NDV-DN40-G2	25,5	G2	6,24	350	41931*	40822*	41934	41935
	<b>ANSI B1.20.1 NPT FEMALE THREAD</b>  	NDV-DN6-1/8"NPT	9	1/8" NPT	0,12	350	30856*	37631*	37636
NDV-DN8-1/4"NPT		12	1/4" NPT	0,25	350	21346*	30744*	37637	37644
NDV-DN10-3/8"NPT		12	3/8" NPT	0,40	350	21347*	37632*	37638	32407
NDV-DN12-1/2"NPT		14	1/2" NPT	0,60	350	21348*	37633*	29585	37645
NDV-DN16-3/4"NPT		14	3/4" NPT	1,10	350	30861*	14585*	37639	30677
NDV-DN20-1"NPT		19,5	1" NPT	2,40	350	30863	37634	37640	32390
NDV-DN25-1 1/4"NPT		21	1 1/4" NPT	2,80	350	30865	28835	37641	37646
NDV-DN30-1 1/2"NPT		24	1 1/2" NPT	3,50	350	30866	37635	37642	37647
NDV-DN40-2"NPT		19,9	2" NPT	6,30	350	41932	41938	41936	41937
<b>SAE J514/ISO/DIS11926-1 FEMALE THREAD</b>  		NDV-DN8-7/16"UNF	13	7/16"-20 UNF	0,28	350	36257	37672	37673
	NDV-DN10-9/16"UNF	13,5	9/16"-18 UNF	0,42	350	37648	37649	37650	37651
	NDV-DN12-3/4"UNF	14	3/4"-16 UNF	0,69	350	37652	37653	37654	37655
	NDV-DN16-1 1/16"UN	20	1 1/16"-12 UN	1,14	350	37656	37657	37658	37659
	NDV-DN20-1 5/16"UN	20	1 5/16"-12 UN	2,19	350	37660	37661	37662	37663
	NDV-DN25-1 5/8"UN	20	1 5/8"-12 UN	2,89	350	37664	37665	37666	37667
	NDV-DN30-1 7/8"UN	20	1 7/8"-12 UN	3,70	350	37668	37669	37670	37671
	NDV-DN40-2 1/2"UN	20	2 1/2"-12 UN	6,30	350	41933	41939	41940	41941

Please note the pressure ratings of the tube connections!

\*Article usually in stock.



# Flow characteristics

# NDV, NDRV, NDVP, NDRVP

The flow values are valid for hydraulic oil (spissitude 880 kg/m<sup>3</sup>) and the kinematic viscosity  $\nu$  of 35 mm<sup>2</sup>/s.

### NDV/NDRV/NDVP/NDRVP-DN6

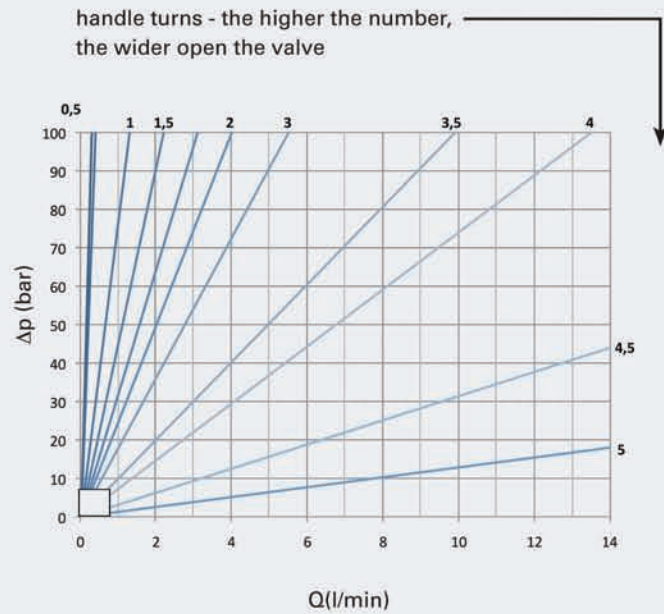

### NDV/NDRV/NDVP/NDRVP-DN8

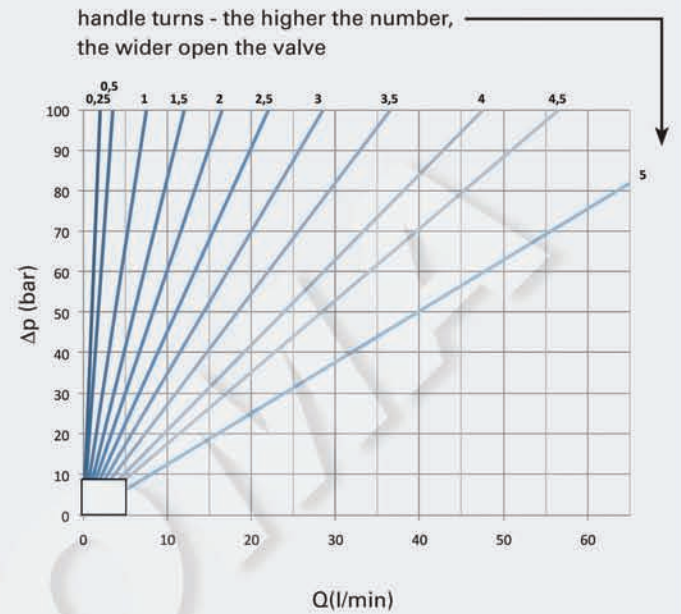

### NDV/NDRV/NDVP/NDRVP-DN10

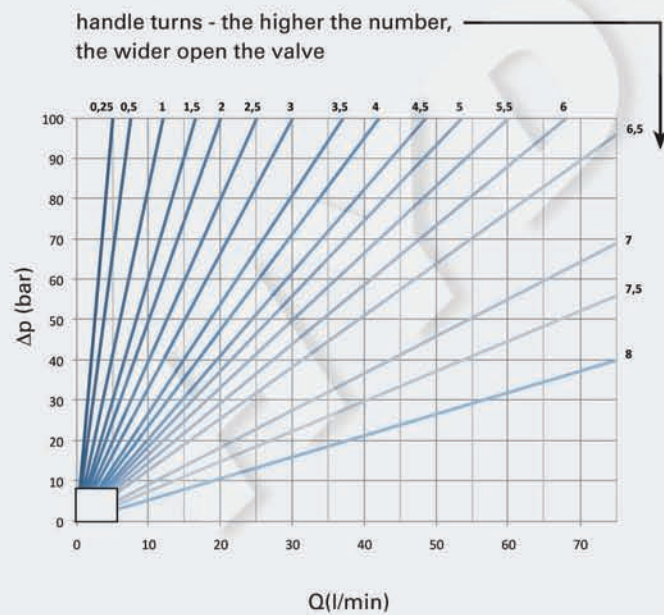

### NDV/NDRV/NDVP/NDRVP-DN12

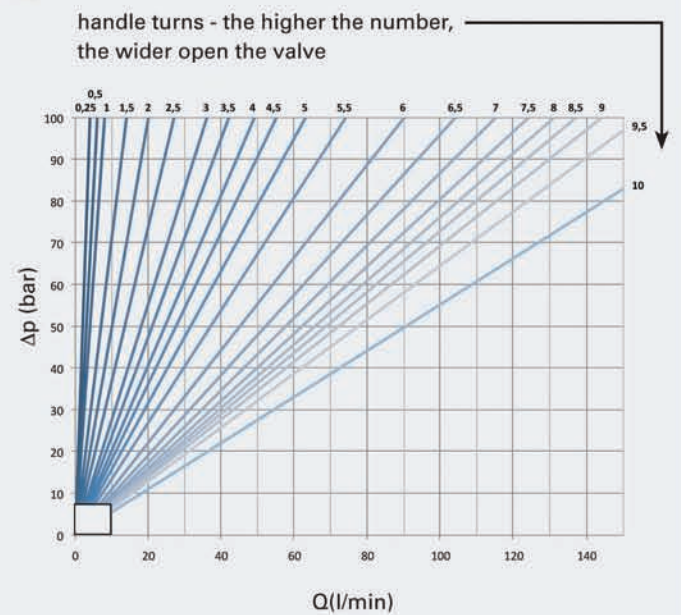

The flow values are valid for hydraulic oil (spissitude 880 kg/m<sup>3</sup>) and the kinematic viscosity  $\nu$  of 35 mm<sup>2</sup>/s.

## NDV/NDRV/NDVP/NDRVP-DN16

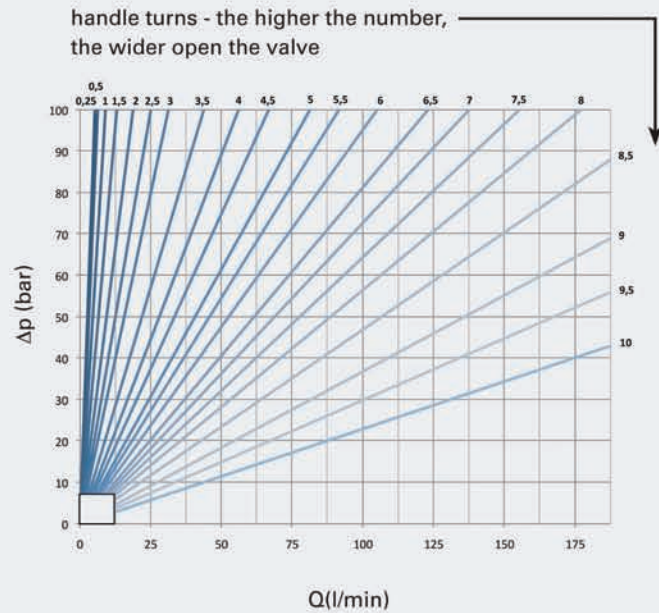

## NDV/NDRV/NDVP/NDRVP-DN20/25/30/40

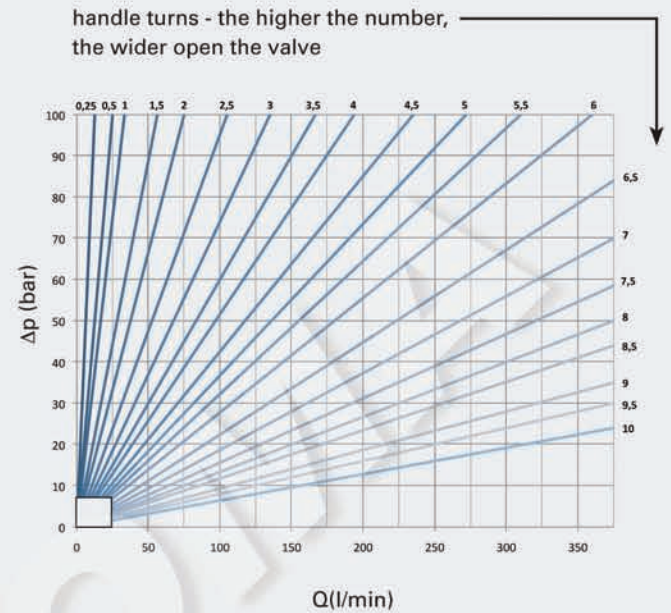

## NDRV/NDRVP-DN6 - DN40

### Flow direction: B-A

$\Delta p$  characteristic line free flow through check valve

