

Part number:

HYDROMA

HYDRAULICKÉ SYSTÉMY

**HIDROMA
SYSTEMS**

UKŁADY HYDRAULICZNE

HYDROMA

ГИДРАВЛИЧЕСКИЕ СИСТЕМЫ

In line pressure compensated double-acting flow control valves

FT 270/2

Compensated double-acting flow control valves available from 1/4" to 1" BSPP size, max. working pressure 250 Bar, adjustable oil flow rate from 2 to 140 Lt./min. (depending on the size) - Precision in compensation +/- 5% max

Double-acting control

Pressure compensated In line or panel mounting

Carbon steel

Connections: F - F Female - Female

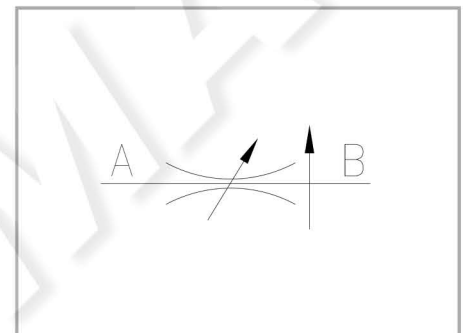

Technical information

Technical description

The pressure compensated valves FT 270/2 are made up of an adjustable orifice and of a pressure compensator piston. Inside the base they are equipped with wide transversal sections which reduce the pressure drop. The accuracy of the internal components processing ensures a very low hysteresis and a remarkable precision in compensation that for this series is around $\pm 5\%$ of the flow rate. The accurate checks carried out on the products ensure a proper functioning of the valves also in heavy working conditions and an excellent lasting reliability.

Materials

CORPO BASE / BASE BODY	Acciaio/Steel 11 S Mn Pb 37-UNI EN 10087
SPILO DI REGOLAZIONE / ADJUSTING NEEDLE	Acciaio legato/Alloy steel
CORPO CARTUCCIA / CARTRIDGE BODY	Acciaio/Steel 39 Ni Cr Mo 3-UNI EN 10083
GUARNIZIONI / GASKETS	Di serie NBR - A richiesta FPM/Standard NBR-on demand FPM
ANELLI ANTIESTRUSIONE / ANTIEXTRUSION RINGS	PTFE
MANOPOLA TIPO MA - RA / KNOB TYPE MA - RA	Alluminio/Aluminum GD AlSi12 - UNI EN AB 46100
MANOPOLA TIPO MP / KNOB TYPE MP	ABS

Technical data

TIPO / TYPE	PRESSIONE ESERCIZIO BAR / WORKING PRESSURE BAR	MIN. ΔP DI FUNZIONAMENTO BAR / MIN. WORKING ΔP BAR	TEMPERATURA ESERCIZIO / WORKING TEMPERATURE	GRADO DI FILTRAZIONE μm / FILTRATION GRADE μm
14	250	5	-20°C/+70°C	25
38	250	7	-20°C/+70°C	25
12	250	10	-20°C/+70°C	25
34	250	10	-20°C/+70°C	25
100	250	16	-20°C/+70°C	25

Dimensional tables and drawings

TIPO / TYPE	A UNI 338	B	C	D	E
14	1/4" G	12,5	96	81,5	88,5
38	3/8" G	13	112,5	94,5	103
12	1/2" G	15,5	141,5	112	122
34	3/4" G	17	168	138	150
100	1" G	21	216	175	192

TIPO / TYPE	ØF	G	H	CH	PESO / WEIGHT KG
14	27	15	M20x1	30	0,580
38	33	17	M25x1,5	35	0,940
12	38	18	M30x1,5	45	1,830
34	47	24	M40x1,5	55	3,350
100	58	32	M50x1,5	70	7,000

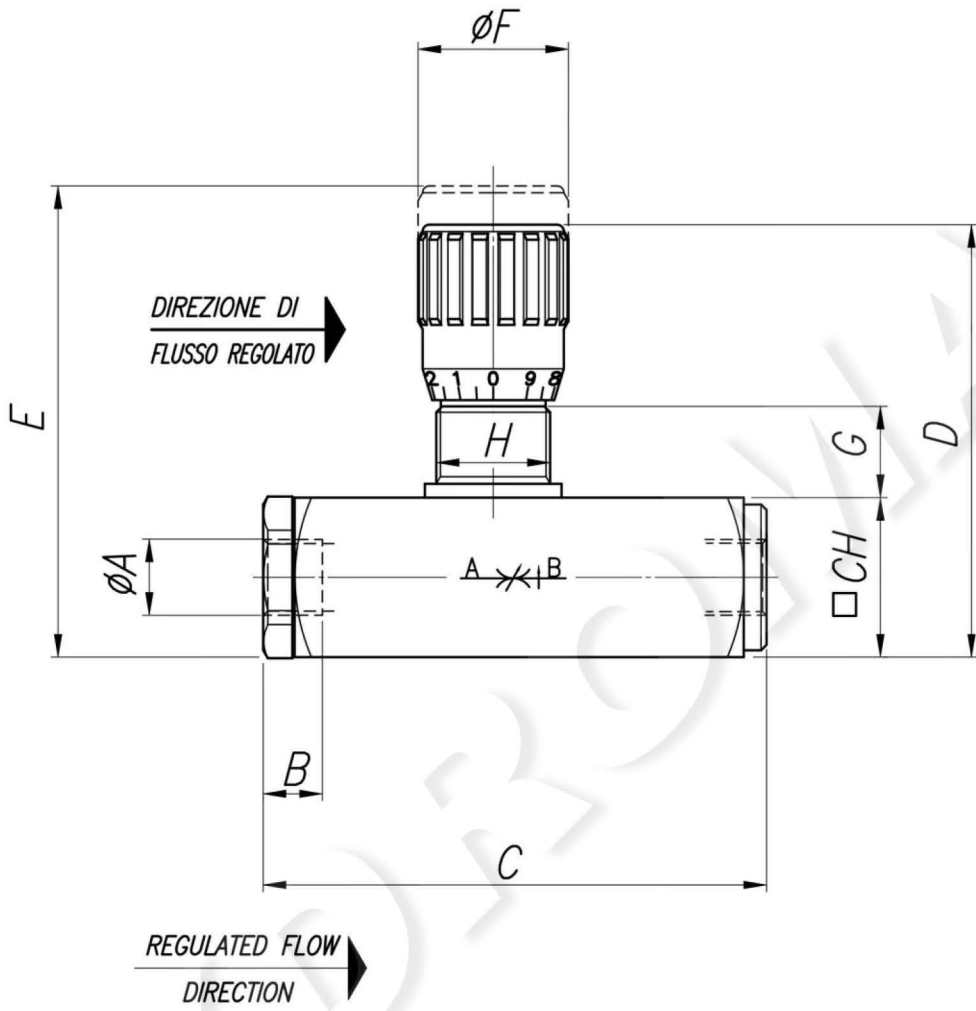

Flow rate curves

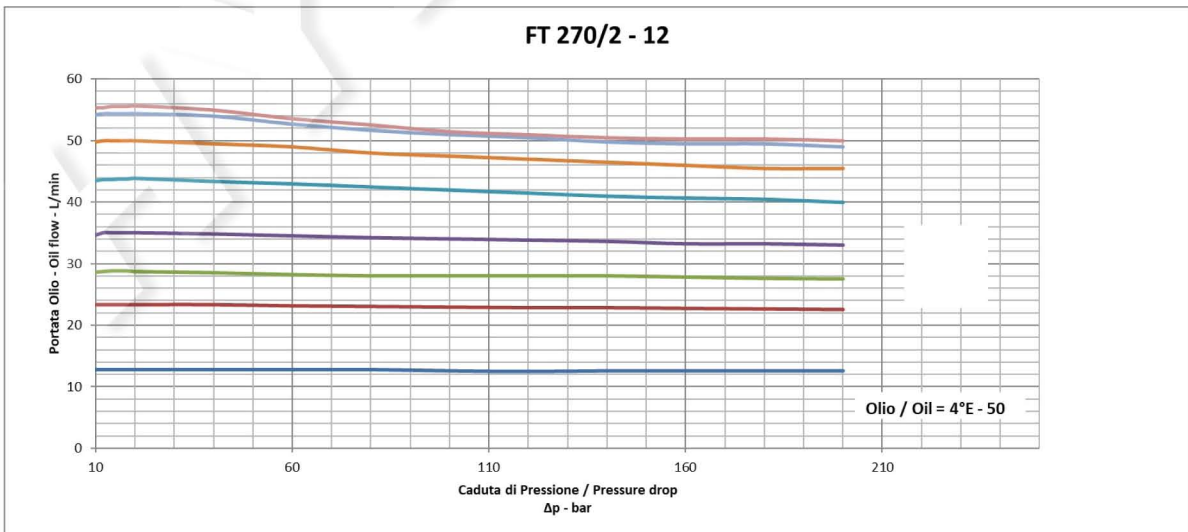
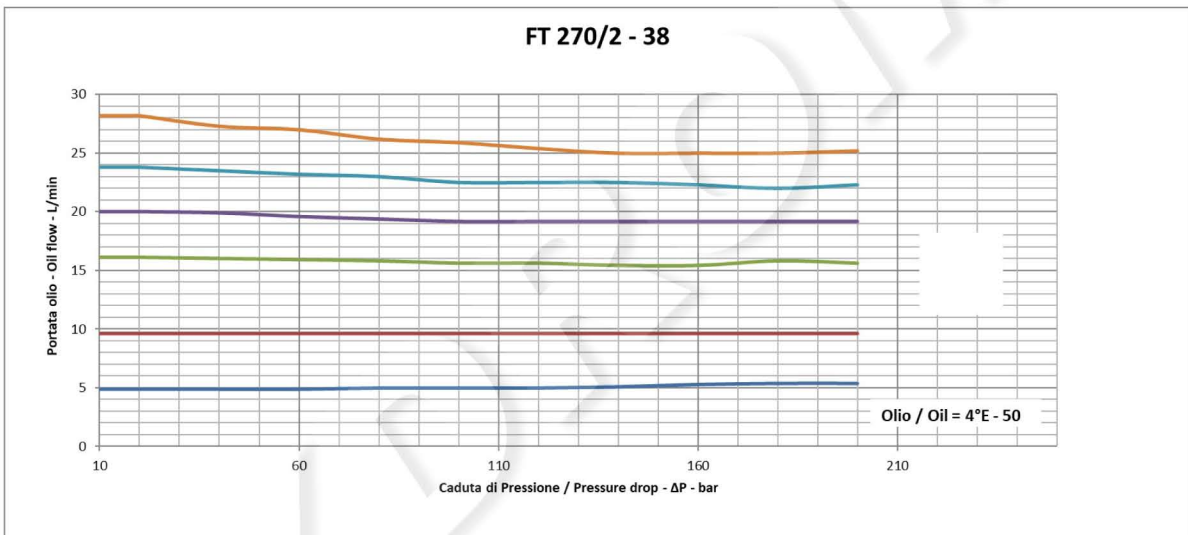
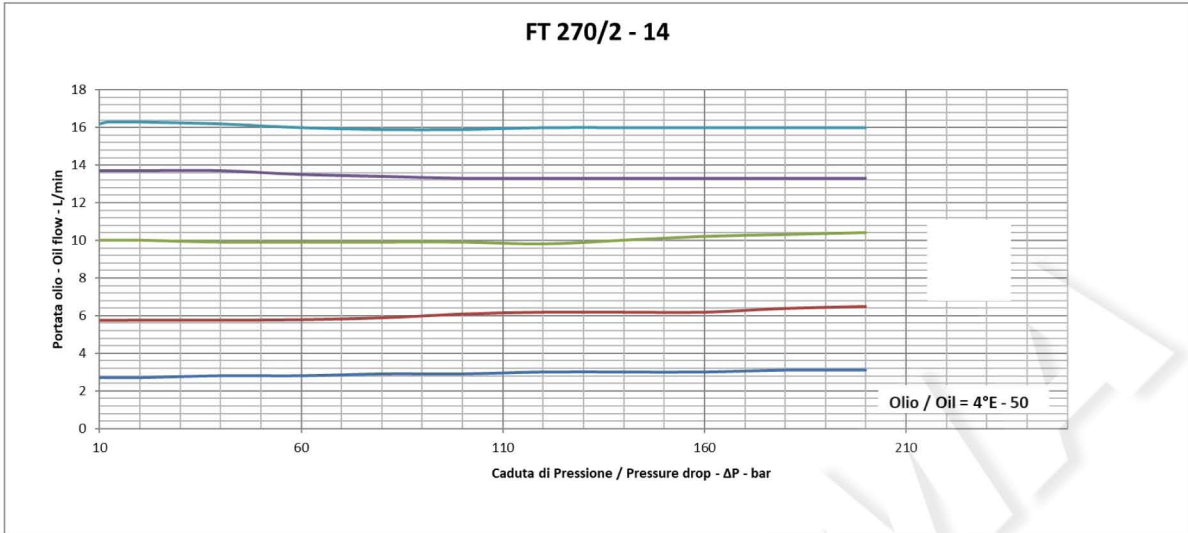

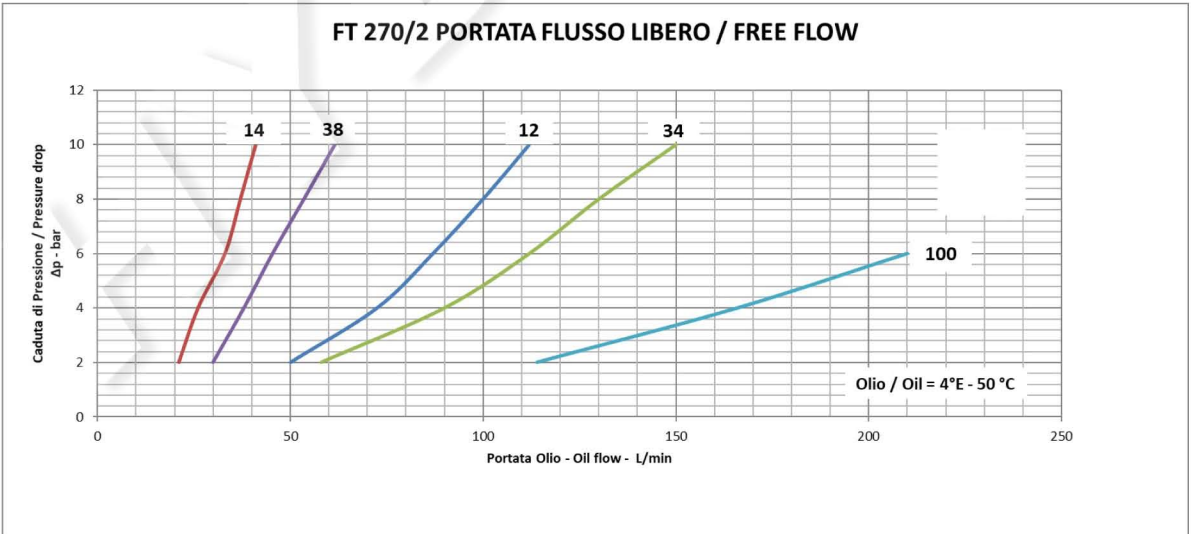
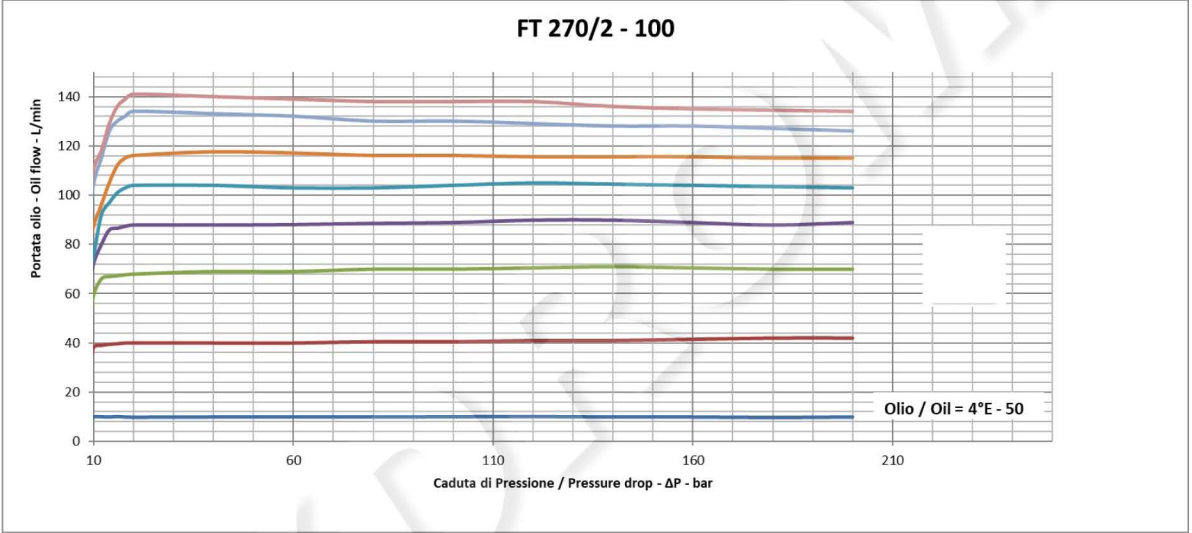
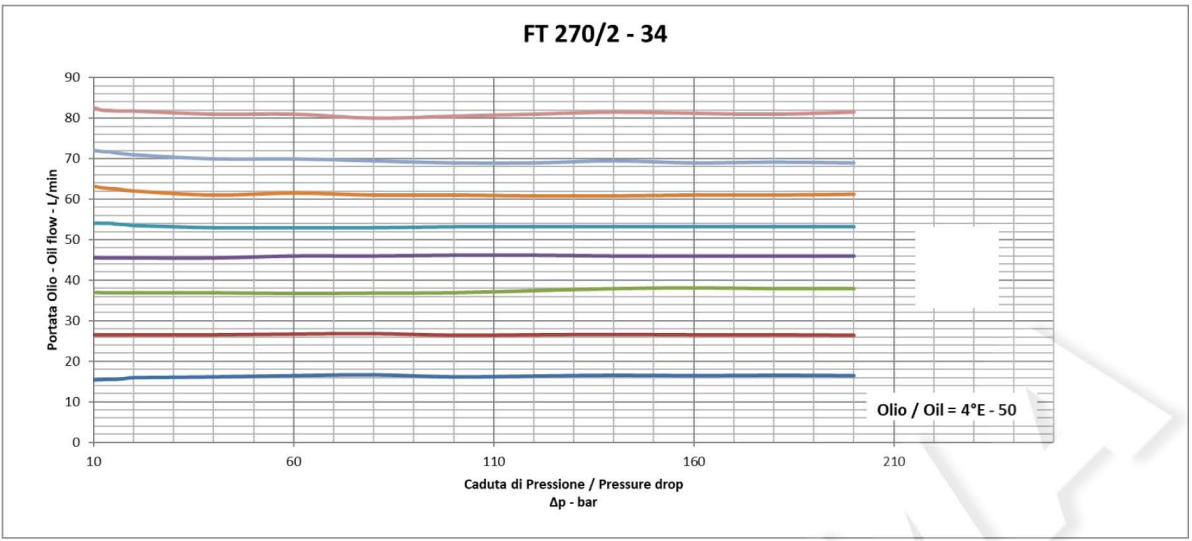

FT 270/2

