

Part number:

HYDROMA

HYDRAULICKÉ SYSTÉMY

**HIDROMA
SISTEMS**

UKŁADY HYDRAULICZNE

HYDROMA

ГИДРАВЛИЧЕСКИЕ СИСТЕМЫ

ALP2

COME ORDINARE / HOW TO ORDER

ALP2	TIPO TYPE	ROTAZIONE ROTATION	TAGLIA SIZE	ALBERO* SHAFT*	PORTE* PORTS*	GUARNIZIONI* SEALS*	OPZIONI* OPTIONS*	DRENAGGIO DRAIN
	omit	D DESTRA CLOCKWISE	6					
	A	S SINISTRA COUNTER CLOCKWISE	9					
	BK1	R** REVERSIBILE REVERSIBLE	10					
	BK2		12					
	BK4		13					
	BK7		16					
			20					
			22					
			25					
			30					
			34					
			37					
			40					
			50					

Guarnizioni / Seals
omit (T range = -10°C + 80°C)
V
...

Opzioni / Options
TR
VM
OR***
T

Drenaggio / Drain
E0 = drenaggio interno/internal drain
E1 = drenaggio esterno/external drain G1/4
**** E2 = drenaggio esterno/external drain 9/16-18 UNF
E3 = drenaggio esterno/external drain G3/8 (solo per opzione VM/only for VM options)
**** E4 = drenaggio esterno/external drain 7/16-20 UNF (solo per rotazione R e porte KA/only for R rotation and KA ports)

(*) = campi da specificare se diversi dallo standard "tipo pompa" / to be specified if different from standard pump type
(**) = La rotazione reversibile R è disponibile per tutte le taglie indicate (eccetto 6) / R rotation is available for all listed displacements (except 6)
(***) = solo per tipi pompa A e BK1 / only for A and BK1 pump types
(****) = Le porte di drenaggio sono lavorate secondo la specifica SAE J1926/1 (ISO 11926-1) relativa a porte filettate con tenuta O-ring / Drain ports are machined in compliance with threaded port with O-ring seal in truncated housing SAE J1926/1 (ISO 11926-1)

Tipi Pompa Standard / Pump Standard Types

omit	= flangia europea + albero T0 + porte E + guarnizioni standard / european flange + shaft T0 + ports E + standard seals
A	= flangia A + albero C1 + porte FA + guarnizioni standard / flange A + shaft C1 + ports FA + standard seals
BK1	= flangia BK1 + albero T1 + porte D + guarnizioni standard / flange BK1 + shaft T1 + ports D + standard seals
BK2	= flangia BK2 + albero T2 + porte D + guarnizioni standard / flange BK2 + shaft T2 + ports D + standard seals
BK4	= flangia BK4 + albero T2 + porte D + guarnizioni standard / flange BK4 + shaft T2 + ports D + standard seals
BK7	= flangia BK7 + albero G0 + porte D + guarnizioni standard / flange BK7 + shaft G0 + ports D + standard seals

Esempi / Examples:

ALP2-D-6	= pompa destra, 4.5 cc/rev, flangia europea, albero conico 1:8, porte flangiate tipo E, guarnizioni standard clockwise rotation, 4.5 cc/rev, european flange, 1:8 tapered shaft, flanged ports E type, standard seals
ALP2-D-6-CO	= pompa destra, 4.5 cc/rev, flangia europea, albero cilindrico (CO), porte flangiate tipo E, guarnizioni standard clockwise rotation, 4.5 cc/rev, european flange, cylindrical shaft (CO), flanged ports E type, standard seals
ALP2BK2-D-6-E	= pompa destra, 4.5 cc/rev, flangia tedesca quadrata, albero conico 1:5, porte flangiate tipo (E), guarnizioni standard clockwise rotation, 4.5 cc/rev, german square flange, 1:5 tapered shaft, european flanged ports (E), standard seals
ALP2A-D-6-OR	= pompa destra, 4.5 cc/rev, flangia SAE a 2 fori, albero cilindrico C1, porte filettate FA, guarnizioni standard, guarnizione OR sul colletto clockwise rotation, 4.5 cc/rev, SAE A 2 bolt flange, cylindrical shaft C1, threaded ports FA, standard seal, OR seal on pilot

LE TAVOLE DI PRODOTTO RAPPRESENTANO I TIPI POMPA STANDARD PER MARZOCCHI POMPE. LE TAVOLE SINOTTICHE DI FLANGE, ALBERI E PORTE HANNO LO SCOPO DI RAPPRESENTARE TUTTE LE POSSIBILI CONFIGURAZIONI DI PRODOTTO. PER MAGGIORI DETTAGLI SULLE DISPONIBILITÀ E CONDIZIONI DI FORNITURA, CONSIGLIAMO DI INTERPELLARE IL NOSTRO UFFICIO TECNICO-COMMERCIALE.

THE PRODUCT DATA SHEETS SHOW OUR STANDARD MODEL TYPES. THE SYNOPSIS TABLES FOR FLANGES, SHAFTS AND PORTS SHOW ALL THE POSSIBLE CONFIGURATIONS. FOR FURTHER DETAILS ABOUT THE AVAILABILITY OF EACH CONFIGURATION PLEASE CONTACT OUR SALES AND TECHNICAL DEPT.

ALP2A

Parti accessorie a corredo della pompa standard: linguetta (codice 522067).
Monta flangia 82-2 (A) secondo norma SAE J744c.

Le porte standard "D" e "d" sono lavorate secondo la specifica SAE J1926/1 (ISO 11926-1) relativa a porte filettate con tenuta O-ring.

Accessories supplied with the standard pump: key (code 522067).

Mounting flange 82-2 (A) in compliance with SAE J744c.

"D" and "d" standard ports are machined in compliance with threaded part with O-ring seal in truncated housing SAE J1926/1 (ISO 11926-1).

MANDATA
OUTLET

ASPIRAZIONE
INLET

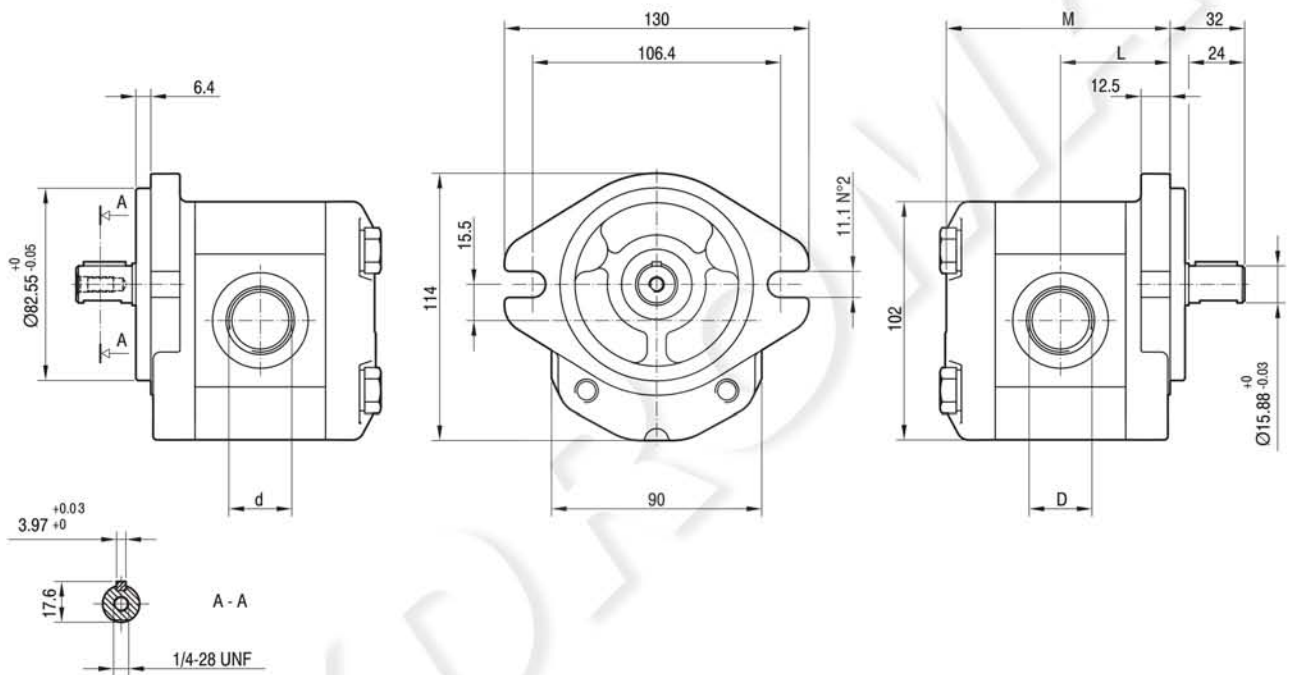

TIPO TYPE	CILINDRATA DISPLACEMENT	PORTATA a 1500 giri/min FLOW at 1500 rev/min	PRESSIONI MASSIME MAX PRESSURE			VELOCITÀ MASSIMA MAX SPEED	DIMENSIONI DIMENSIONS			
			P ₁	P ₂	P ₃		L	M	d	D
	cm ³ /giro [cm ³ /rev]	litri/min [litres/min]	bar	bar	bar	giri/min [rpm]	mm	mm		
ALP2A-D-6	4,5	6,4	250	270	290	4000	45,5	93,5	7/8-14 UNF	1 1/16-12 UNF
ALP2A-D-9	6,4	9,1	250	270	290	4000	47	96,5	7/8-14 UNF	1 1/16-12 UNF
ALP2A-D-10	7,0	10,0	250	270	290	4000	47,5	97,5	7/8-14 UNF	1 1/16-12 UNF
ALP2A-D-12	8,3	11,8	250	270	290	4000	48,5	99,5	7/8-14 UNF	1 1/16-12 UNF
ALP2A-D-13	9,6	13,7	250	270	290	4000	49,5	101,5	7/8-14 UNF	1 1/16-12 UNF
ALP2A-D-16	11,5	16,4	230	250	270	4000	51	104,5	7/8-14 UNF	1 1/16-12 UNF
ALP2A-D-20	14,1	20,1	230	250	270	3200	53	108,5	7/8-14 UNF	1 1/16-12 UNF
ALP2A-D-22	16,0	22,8	210	225	240	2800	54,5	111,5	7/8-14 UNF	1 1/16-12 UNF
ALP2A-D-25	17,9	25,5	210	225	240	2500	56	114,5	7/8-14 UNF	1 1/16-12 UNF
ALP2A-D-30	21,1	30,1	180	195	210	2200	58,5	119,5	7/8-14 UNF	1 1/16-12 UNF
ALP2A-D-34	23,7	33,7	180	195	210	2000	60,5	123,5	7/8-14 UNF	1 1/16-12 UNF
ALP2A-D-37	25,5	36,4	170	185	200	1800	62	126,5	7/8-14 UNF	1 1/16-12 UNF
ALP2A-D-40	28,2	40,1	170	185	200	1800	64	130,5	7/8-14 UNF	1 1/16-12 UNF
ALP2A-D-50	35,2	50,2	140	155	170	2000	69,5	141,5	7/8-14 UNF	1 5/16-12 UNF

Nel caso di funzionamento a pressioni elevate e intermittenti è possibile una riduzione della resistenza a fatica del corpo.
A reduction of body's fatigue strength may occur if the pump is working at elevated and intermittent pressures.

ALP2

FLANGE / FLANGES

ALBERI / SHAFTS

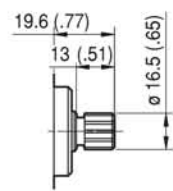
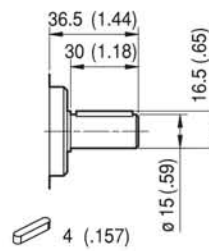
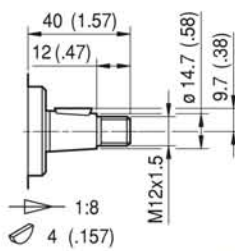
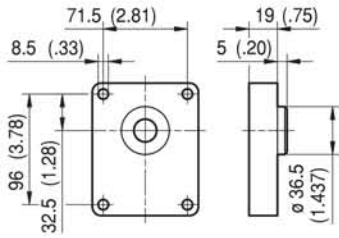

DIN 5482
B17x14

T0

C0

S0

Coppia Max
Max Torque 145 Nm

Coppia Max
Max Torque 125 Nm

Coppia Max
Max Torque 130 Nm

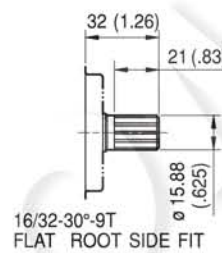
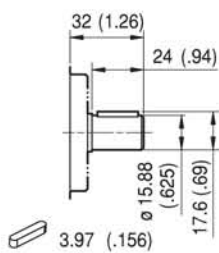
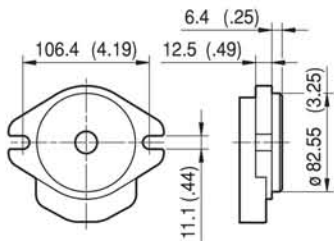

16/32-30°-9T
FLAT ROOT SIDE FIT

C1

S1

Coppia Max
Max Torque 105 Nm

Coppia Max
Max Torque 110 Nm

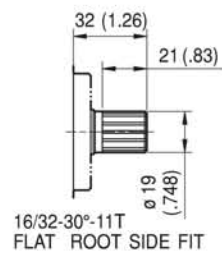
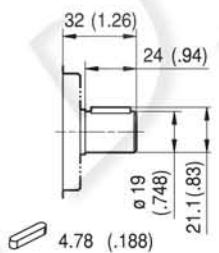

16/32-30°-11T
FLAT ROOT SIDE FIT

C2

S2

Coppia Max
Max Torque 150 Nm

Coppia Max
Max Torque 230 Nm

FLANGE / FLANGES

ALBERI / SHAFTS

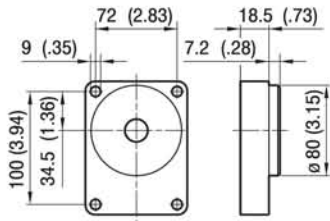

BK1

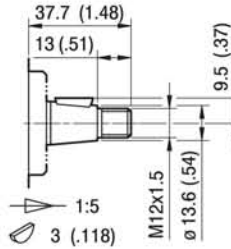

T1

Coppia Max
Max Torque 130 Nm

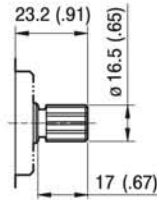

S3

DIN 5482
B17x14
Coppia Max
Max Torque 130 Nm

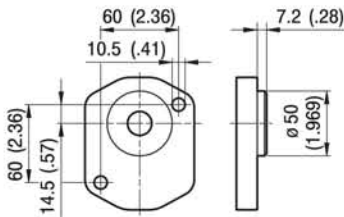

BK2

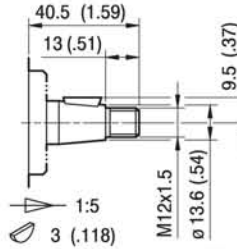

T2

Coppia Max
Max Torque 130 Nm

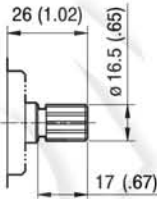

S4

DIN 5482
B17x14
Coppia Max
Max Torque 130 Nm

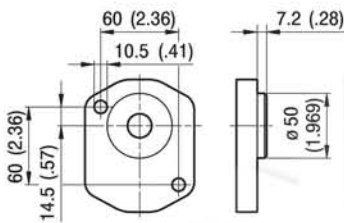

BK4

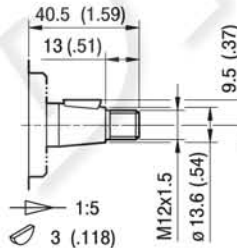

T2

Coppia Max
Max Torque 130 Nm

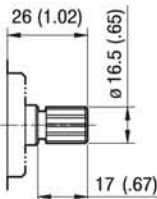

S4

DIN 5482
B17x14
Coppia Max
Max Torque 130 Nm

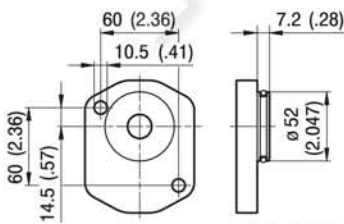

BK7

OR 3181

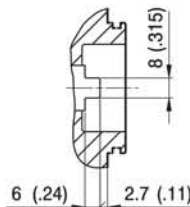

G0

Coppia Max
Max Torque 105 Nm

ALP2

PORTE / PORTS

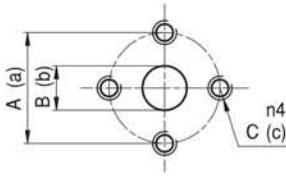

E

TIPO TYPE	ASPIRAZIONE INLET			MANDATA OUTLET		
	A	B	C	a	b	c
ALP2...6 ÷ ALP2...9	30	13	M6	30	13	M6
ALP2...10 ÷ ALP2...13	40	13	M8	40	13	M8
ALP2...16 ÷ ALP2...25	40	19	M8	40	13	M8
ALP2...30 ÷ ALP2...40	40	19	M8	40	19	M8
ALP2...50	40	21	M8	40	19	M8

I valori delle coppie di serraggio delle viti presenti nel kit raccordo sono indicate a pag 57 (capitolo accessori).
Tightening torques of the fittings screws are specified on page 57 (accessories section).

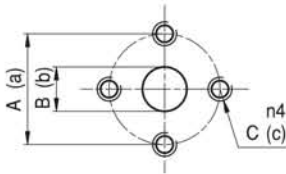

EP

TIPO TYPE	ASPIRAZIONE INLET			MANDATA OUTLET		
	A	B	C	a	b	c
ALP2...6	40	13	M8	30	13	M6
ALP2...10 ÷ ALP2...13	30	13	M6	30	13	M6
ALP2...16 ÷ ALP2...40	40	19	M8	30	13	M6
ALP2...50	40	21	M8	30	19	M6

I valori delle coppie di serraggio delle viti presenti nel kit raccordo sono indicate a pag 57 (capitolo accessori).
Tightening torques of the fittings screws are specified on page 57 (accessories section).

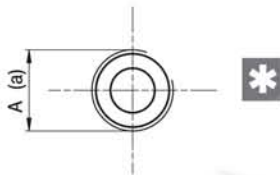

FG

TIPO TYPE	ASPIRAZIONE INLET	MANDATA OUTLET
	A	a
ALP2...6 ÷ ALP2...16	G1/2	G1/2
ALP2...20 ÷ ALP2...50	G3/4	G1/2

Raccordo G1/2 coppia di serraggio massima 50 Nm. Raccordo G3/4 coppia di serraggio massima 60 Nm.
Consigliamo di richiedere conferma al fornitore del raccordo.
Tightening torques for G1/2 fitting: 50 Nm. Tightening torques for G3/4 fitting: 60 Nm. Please check with the fittings suppliers.

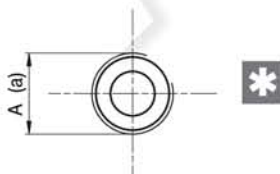

FC

TIPO TYPE	ASPIRAZIONE INLET	MANDATA OUTLET
	A	a
ALP2...6 ÷ ALP2...16	Rc1/2	Rc1/2
ALP2...20 ÷ ALP2...50	Rc3/4	Rc1/2

Raccordo Rc1/2 coppia di serraggio massima 50 Nm. Raccordo Rc3/4 coppia di serraggio massima 60 Nm.
Consigliamo di richiedere conferma al fornitore del raccordo.
Tightening torques for Rc1/2 fitting: 50 Nm. Tightening torques for Rc3/4 fitting: 60 Nm. Please check with the fittings suppliers.

ALP2

PORTE / PORTS

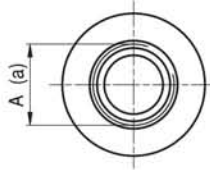

STANDARD SAE J1926/1

FA

TIPO TYPE	ASPIRAZIONE INLET	MANDATA OUTLET
	A	a
ALP2...6 ÷ ALP2...40	1 1/16-12 UNF	7/8-14 UNF
ALP2...50	1 5/16-12 UNF	7/8-14 UNF

Raccordo 7/8-14 UNF coppia di serraggio massima 70 Nm. Raccordo 1 1/16-12 UNF coppia di serraggio massima 70 Nm. Raccordo 1 5/16-12 UNF coppia di serraggio massima 80 Nm. Consigliamo di richiedere conferma al fornitore del raccordo.
Tightening torques for 7/8-14 UNF fitting: 70 Nm. Tightening torques for 1 1/16-12 UNF fitting: 70 Nm.
Tightening torques for 1 5/16-12 UNF fitting: 80 Nm. Please check with the fittings suppliers.

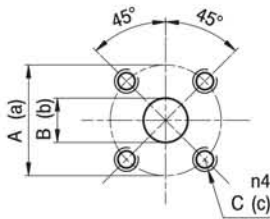

D

TIPO TYPE	ASPIRAZIONE INLET			MANDATA OUTLET		
	A	B	C	a	b	c
ALP2...6 ÷ ALP2...12	40	15	M6	35	15	M6
ALP2...13 ÷ ALP2...40	40	20	M6	35	15	M6

I valori delle coppie di serraggio delle viti presenti nel kit raccordo sono indicate a pag 57 (capitolo accessori).
Tightening torques of the fittings screws are specified on page 57 (accessories section).

ALP2 CURVE CARATTERISTICHE

ALP2 PERFORMANCE CURVES

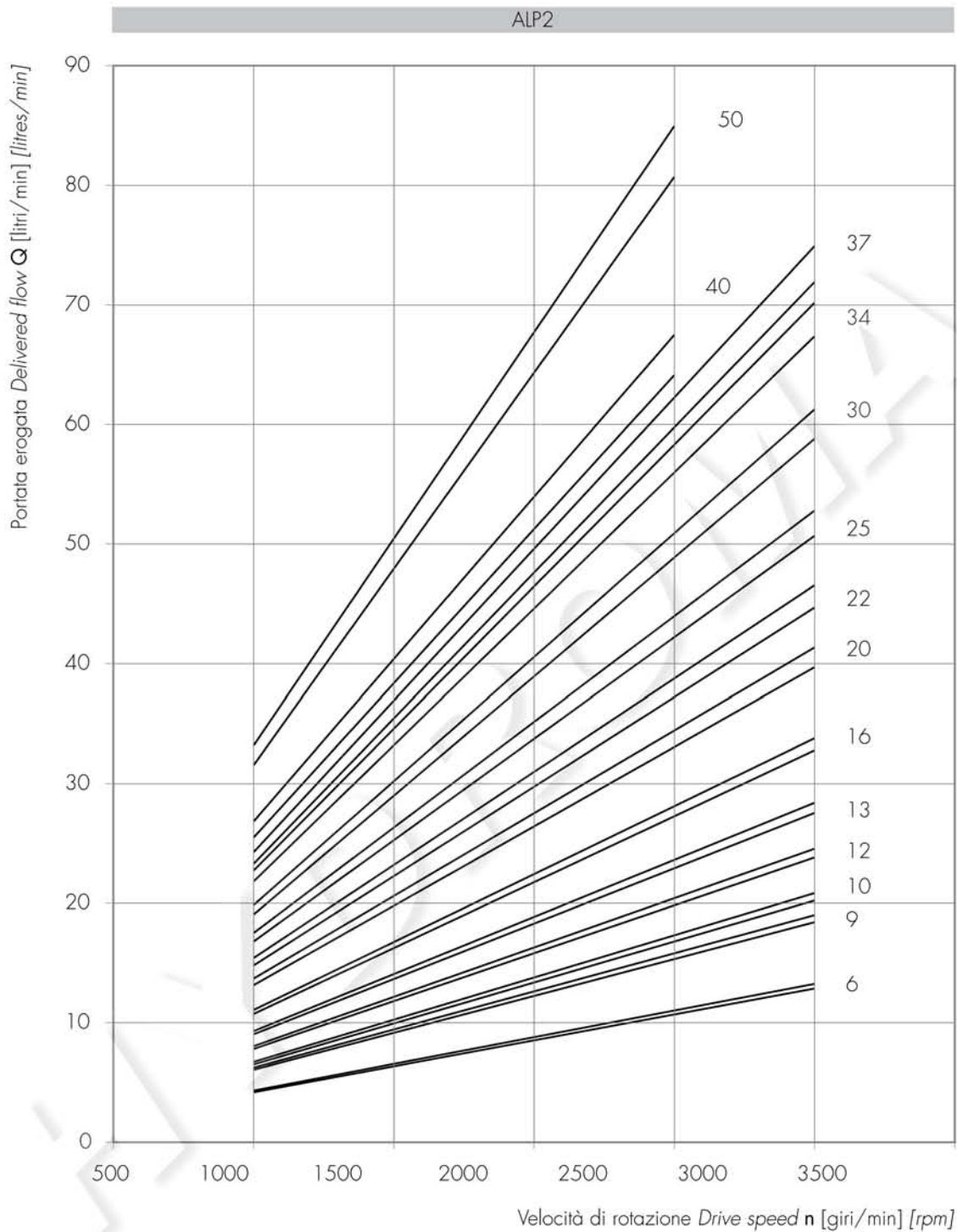

Le curve sono state ottenute alla temperatura di 50°C, utilizzando olio con viscosità 30 cSt alle pressioni sotto riportate.

Each curve has been obtained at 50°C, using oil with viscosity 30 cSt at these pressure.

6 |
9 |— 25-250 bar
10 |
13 |
16 |— 25-240 bar

20 |— 25-220 bar
22 |
25 |— 25-210 bar
30 |— 25-190 bar

34 |— 25-170 bar
40 |— 25-160 bar
50 |— 25-130 bar

Potenza assorbita Absorbed power P [kW]
 Momento torcente assorbito Absorbed torque M [Nm]
 Velocità di rotazione Drive speed n [giri/min] [rpm]

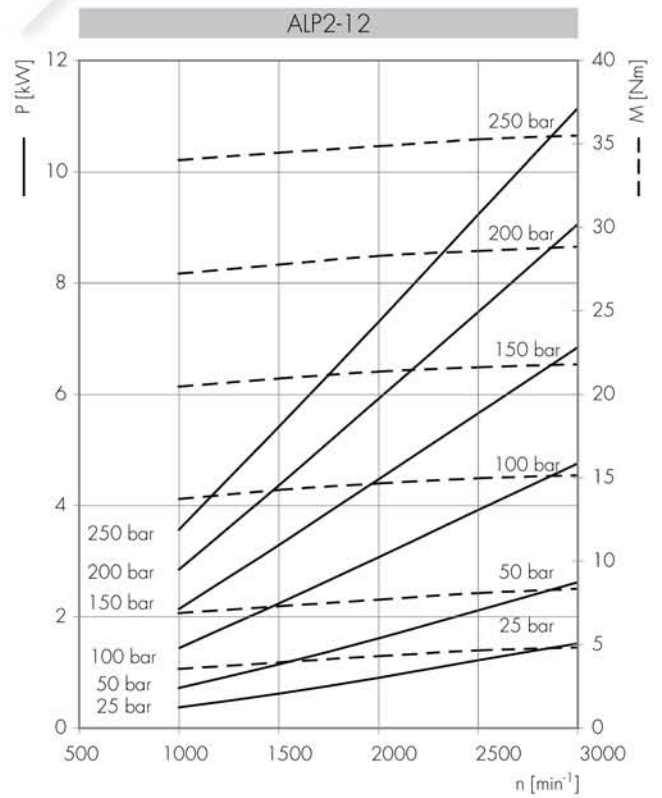
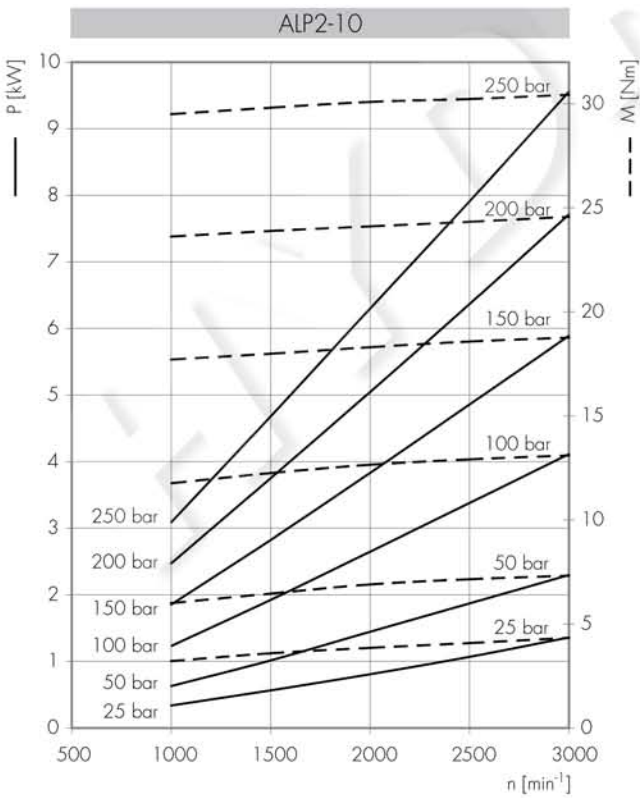
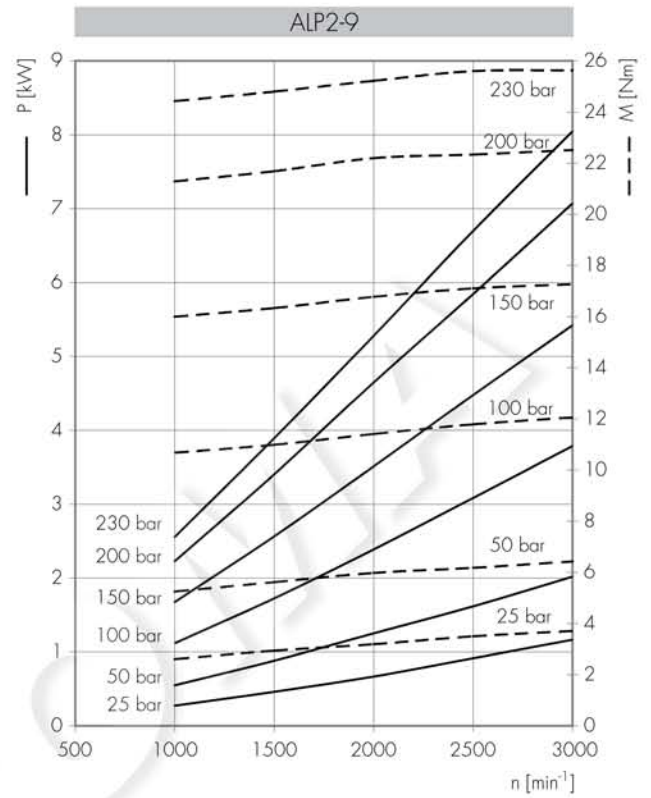
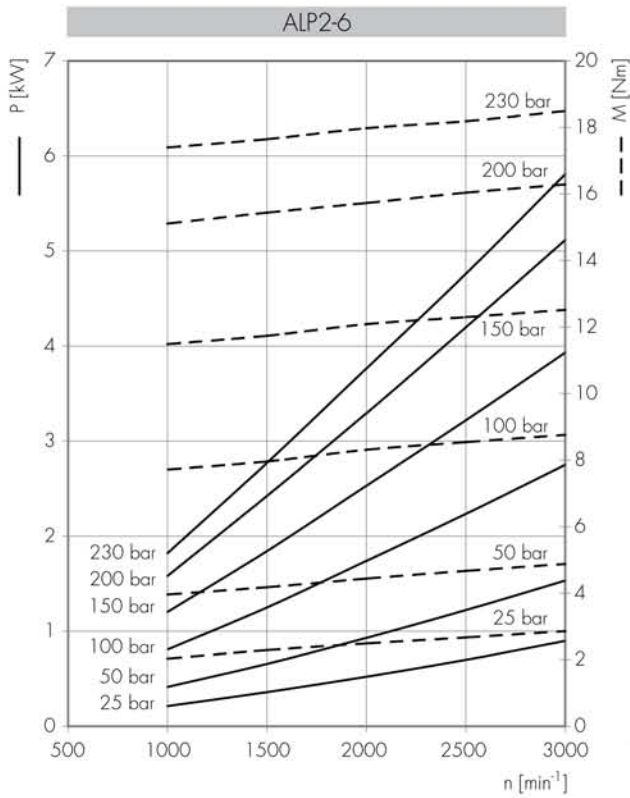

Potenza assorbita *Absorbed power* P [kW]
 Momento torcente assorbito *Absorbed torque* M [Nm]
 Velocità di rotazione *Drive speed* n [giri/min] [rpm]

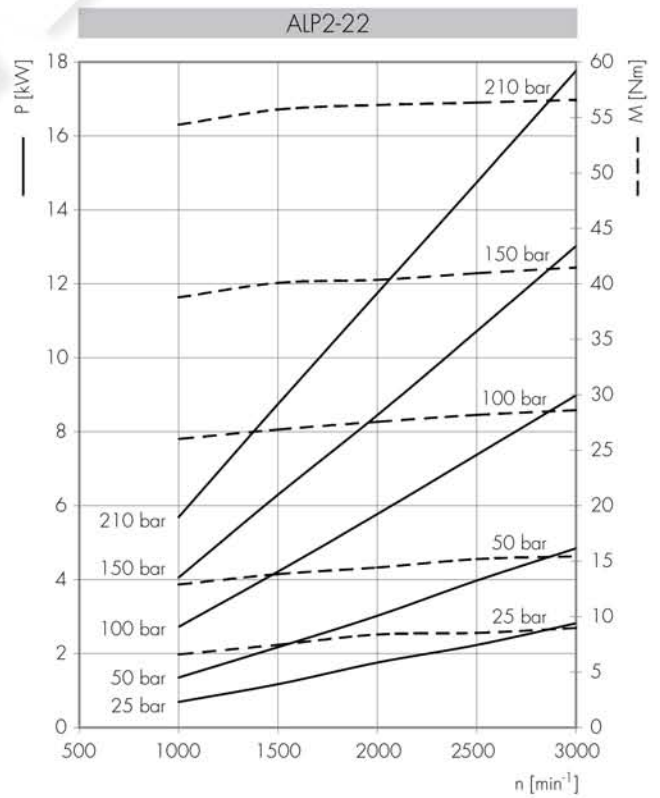
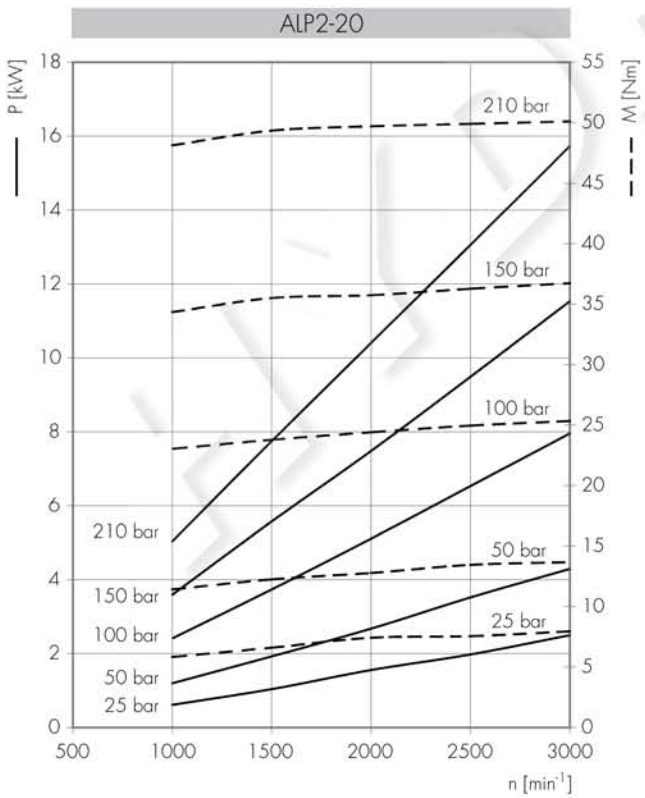
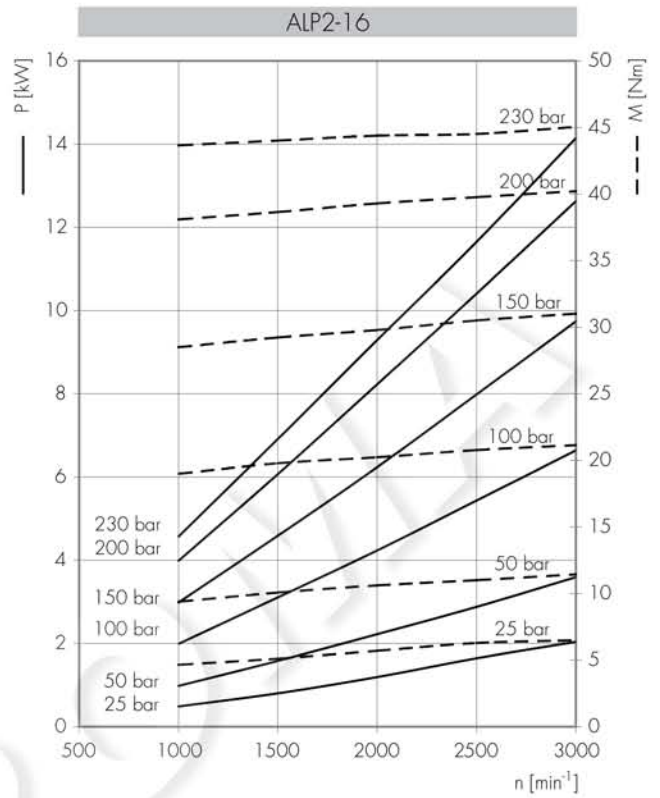
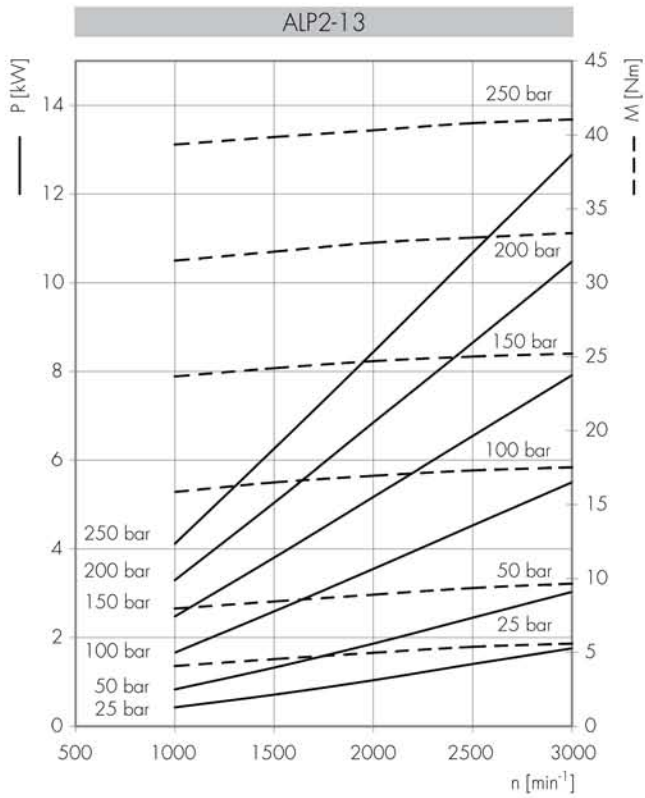

Potenza assorbita Absorbed power P [kW]
 Momento torcente assorbito Absorbed torque M [Nm]
 Velocità di rotazione Drive speed n [giri/min] [rpm]

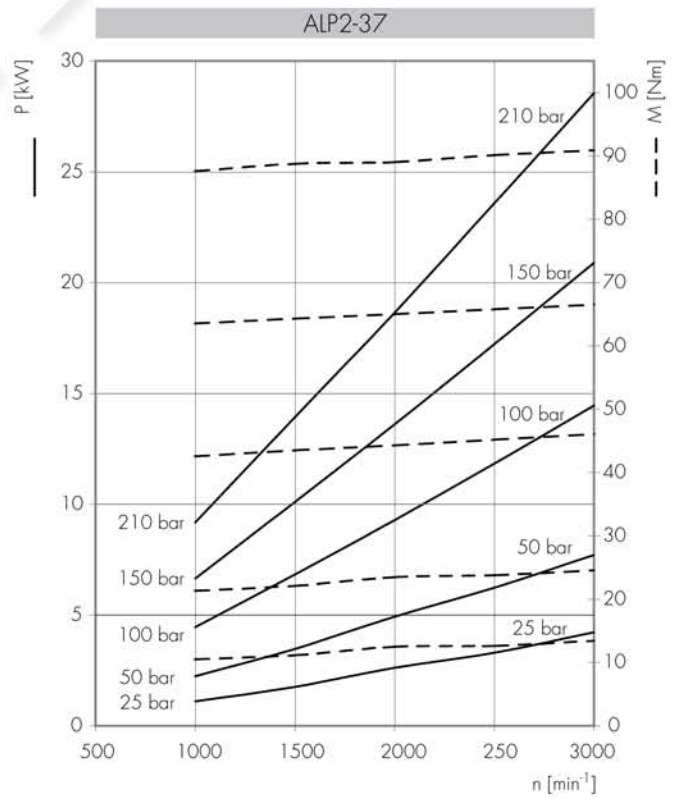
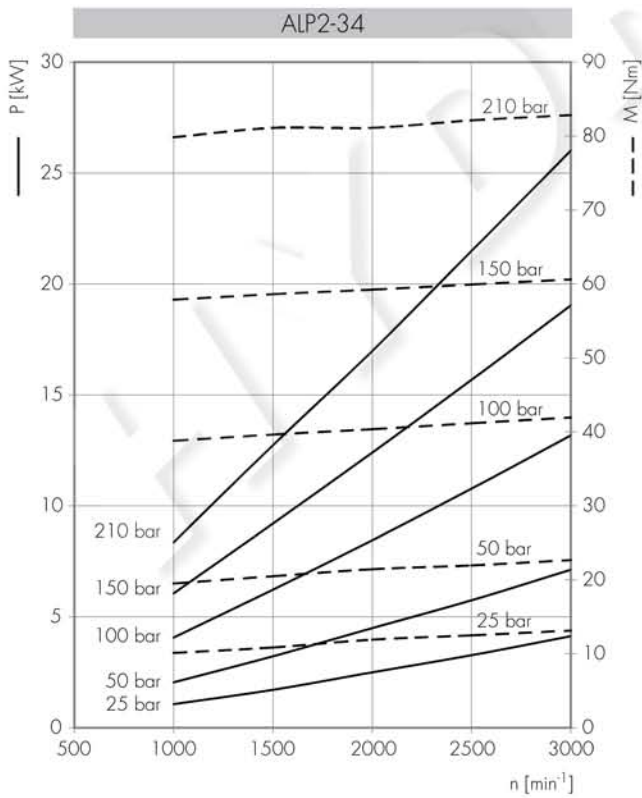
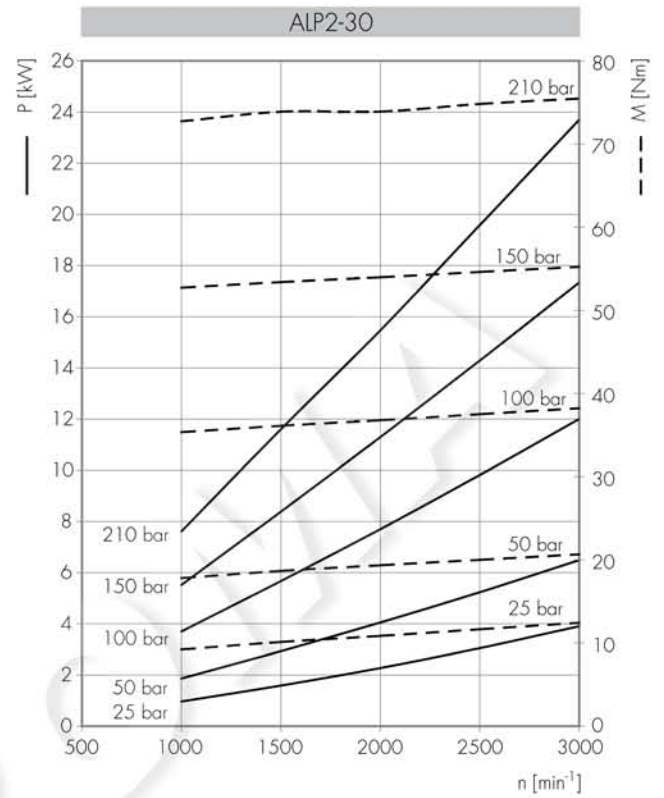
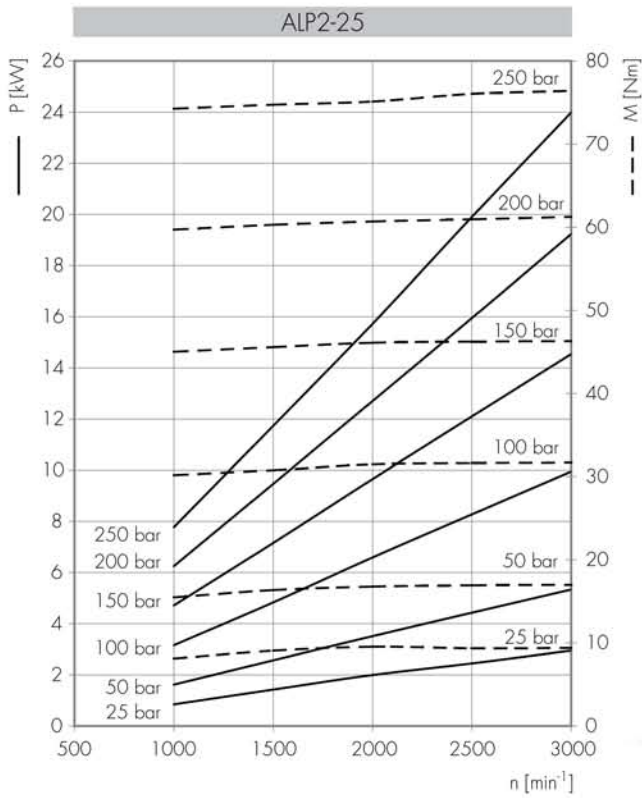

Potenza assorbita *Absorbed power* **P** [kW]
 Momento torcente assorbito *Absorbed torque* **M** [Nm]
 Velocità di rotazione *Drive speed* **n** [giri/min] [rpm]

