

ON APPLICATION / USAGE OF THE PRODUCTS

Although our products are designed on the basis of our profound knowledge and long experience, and manufactured under the strict quality control system, the following must be taken into consideration in actual use.

1

The operating conditions of the products shown in this catalog vary depending upon each application. Therefore, the decision of the products' suitability to the system considered must be made by the designer of the hydraulic system and/or the person in charge of determining the specification after making analysis and conducting tests, if necessary. The study of the specification shall be done based on the latest catalog and technical documents, and the system must be composed taking into account situations regarding the possibility of machine failure.

2

Prior to use of the products, descriptions given in the SAFETY PRECAUTIONS must be observed for the proper use.

3

The technical information in this catalog represents typical characteristics and performance of the products, and is not guaranteed one.

4

In case the products are used in the following conditions or environments, please consult us prior to the use.

- ① Unspecified conditions or environments
- ② Use for atomic power, aviation, medical treatment, and/or food
- ③ Use likely to affect human beings or assets significantly or requiring particular safety

5





The information described in this catalog is subject to change without notice. For updated information, please consult our company.

SAFETY PRECAUTIONS



Before you use the product, you **MUST** read the operation or operators manual and **MUST** fully understand how to use the product.



To use the product safely, you **MUST** carefully read all Warnings and Cautions in this manual. You **MUST** also observe the related regulations and rules regarding safety.

■ Cautions related to operation





- ①  Use the safety equipment to avoid the injury when you operate the product.
CAUTION
- ②  Pay enough attention on handling method to avoid pinching hands or back problems that may be caused by heavy weight of the product or handling posture.
CAUTION
- ③  Do not step on the product, hit it, drop it or give strong outside force to it, as one of these actions may cause the failure of work, damage or oil leakage.
CAUTION
- ④  Wipe the oil on the product or floor off completely, as the oil creates slippery conditions that may result in dropping the product or injuring.
CAUTION



■ Warnings and Cautions related to installation and removal of the product

- ①  Installation, removal, plumbing, and wiring must be done by the certified person.
CAUTION
*CERTIFIED PERSON: a person who has enough knowledge like a person who is trained by Kawasaki's hydraulic school.
- ②  Make it sure that the power of the hydraulic power unit is turned off and that the electric motor or engine has completely stopped before starting installation or removal. You must also check the system pressure has dropped to zero.
WARNING





- ③  Turn off the power before starting wiring or other works related to the electric power, otherwise you may be stuck by an electric shock.
WARNING
- ④  Clean the threads and mounting surface completely, otherwise you may experience damages or oil leakage caused by insufficient tightening torque or broken seal.
CAUTION
- ⑤  Use the specified bolts and keep the specified tightening torque when you install the product. Usage of unauthorized bolts, lack of torque or excess of torque may create problems such as failure of work, damage and oil leakage.
CAUTION

■ Warnings and Cautions for operation

- ①  Never use the product not equipped with anti-explosion protection in the circumstances of possible explosion or combustion.
DANGER
- ②  Shield the rotating part such as motor shaft and pump shaft to avoid injuries caused by being caught of fingers or cloths.
WARNING
- ③  Stop the operation immediately if you find something wrong such as unusual noise, oil leakage or smoke, and fix it properly. If you continue operating, you may encounter damage, fire or injury.
WARNING
- ④  Make it sure that plumbing and wiring are correct and all the connection is tightened correctly before you start operating, especially if it is the first run.
CAUTION





- ⑤  Use the product under the specification mentioned in the catalog, drawings and specification sheet.
CAUTION
- ⑥  Keep your body off the product during the operations as it may become hot and burn your body.
CAUTION
- ⑦  Use the proper hydraulic oil, and maintain the contamination in the recommended level, otherwise it may not work or be damaged.
CAUTION

■ Cautions related to maintenance

- ①  Never modify the product without approval of Kawasaki.
CAUTION
- ②  Do not disassemble and assemble without approval by Kawasaki. It may cause troubles and failure, or it may not work as specified. If it is necessary by all means to disassemble and assemble, it must be done by an authorized person.
CAUTION
- ③  Keep the product from dust and rust by paying attention to the surrounding temperature and humidity when you transport or store the product.
CAUTION
- ④  Replacing the seals may be required if you use the product after long time storage.
CAUTION

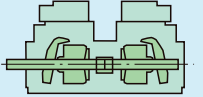
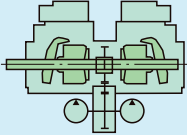
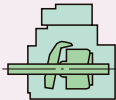
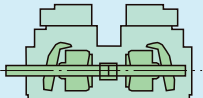
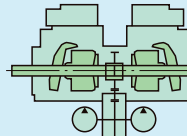
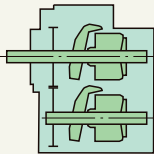
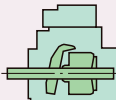
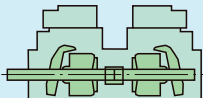
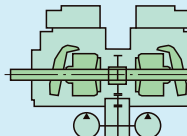
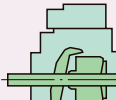
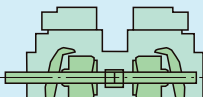
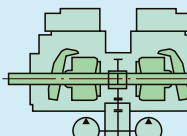
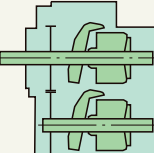
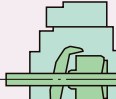
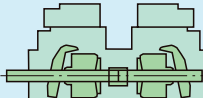
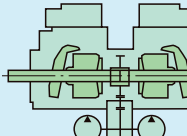
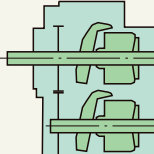
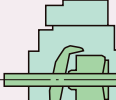
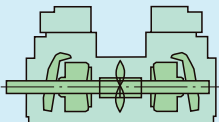
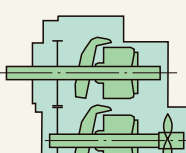
Out of a Wide Variety of Our Swash Plate Type Axial Piston Pumps, We Introduce below Those Most Suitable for Construction Machines with Open Circuits.

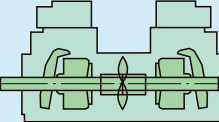
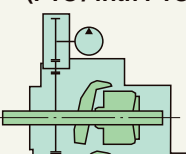
KPM Swash Plate Type Axial Piston Pumps Programs for Industrial Vehicles

displacement	double pump (tandem type)	double pump (parallel type)	single pump	
60 cm ³	<p>K3V63DT /K5V80DT</p> 	<p>K3V63DTP /K5V80DTP</p> 	<p>K3V63S/K5V80S</p> 	
80				
110	<p>K3V112DT /K5V140DT</p> 	<p>K3V112DTP /K5V140DTP</p> 	<p>K3V112DP</p> 	<p>K3V112S/K5V140S</p> 
140	<p>K3V140DT</p> 	<p>K3V140DTP</p> 	<p>K3V140S</p> 	
160	<p>K5V160DT</p> 	<p>K5V160DTP</p> 	<p>K5V160DP</p> 	<p>K5V160S</p> 
200	<p>K5V200DT</p> 	<p>K5V200DTP</p> 	<p>K5V200DP</p> 	<p>K5V200S</p> 
	<p>K5V200DTH</p> 	<p>K5V200DPH</p> 	<p>K5V200SH</p> 	
280	<p>K3V280DTH</p> 	<p>K5V200DPH (PTO/with PTO)</p> 	<p>K3V280S</p> 	
			<p>K3V280SH</p> 	

K5V SERIES

With new technology the K5V series has enabled increased power density.

•K3V/K5V

Variation of pump displacement

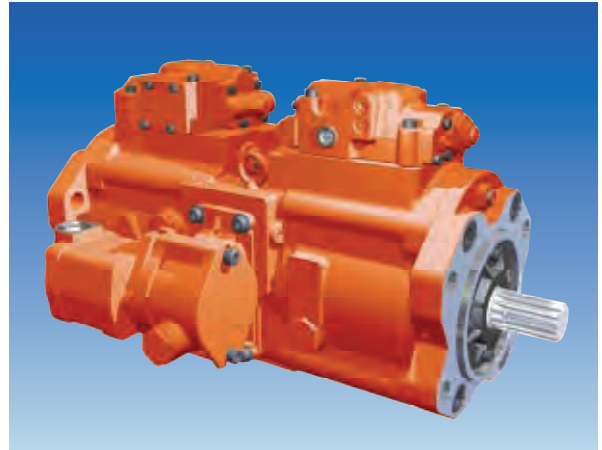
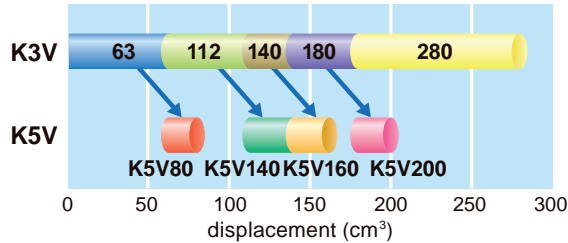

ORDERING CODE

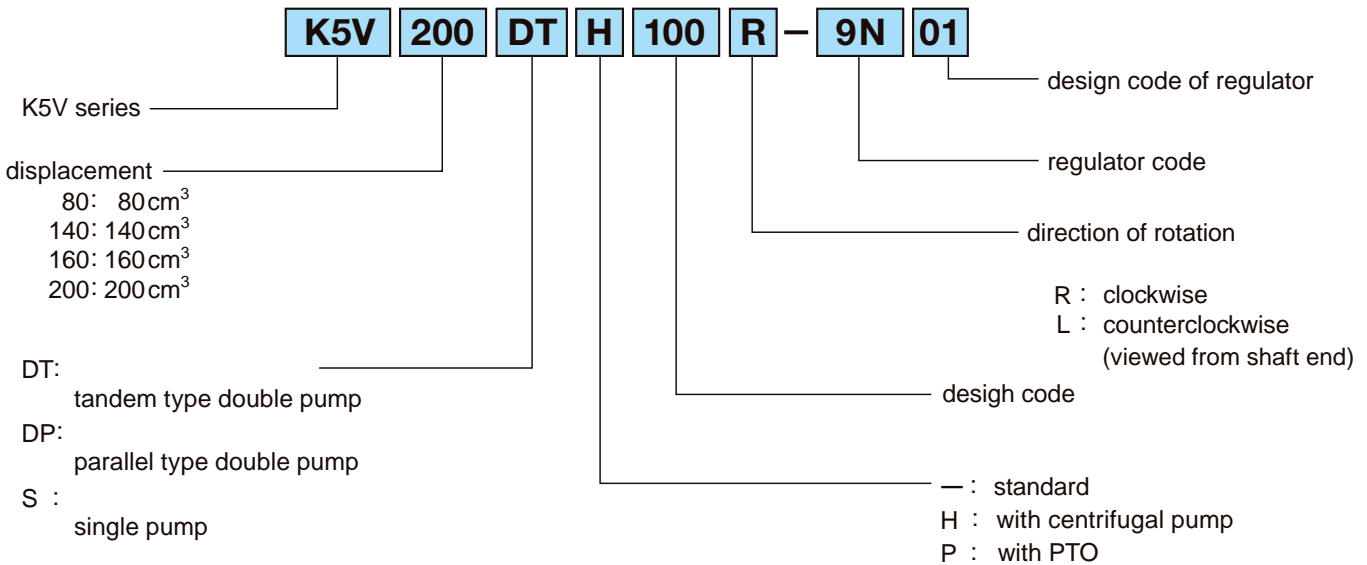

SPECIFICATIONS

1MPa=10.197kgf/cm²
1N·m=0.10197kgf·m

size		80	140	160	200
displacement (cm ³)		80	140	160	200
pressure (MPa)	*1 rated	34.3			
	peak	39.2			
speed (min ⁻¹)	*2 max. for self priming	2,460	2,160	2,000	1,900 (2,200)*4
	*3 max.	3,000	2,500	2,350	2,200
max. input torque of tandem pump (N·m)		529	843	1,120	
max. input torque of attached gear pump with PTO		125		294	
mass (kg)	single	48	68	86	
	tandem	81	125	160	
hydraulic fluid	type	*5 antiwear hydraulic fluid			
	oil temperature range	- 20 ~ + 95 °C			
	oil viscosity range	10 ~ 1,000mm ² /S (cSt)			
	filtration	suction line	80 ~ 150 mesh		
return line		nominal 10 micron meter			

*1. Pressure to which guarantee of performance, functions or service life is applied. Durability is unlimited (except for the bearing life).

*2. At max. displacement. In case of engine driving, max. idling speed should be below this value. This suction pressure should be -0.01MPa and above.

*3. Suction pressure should be above 0.1MPa.

*4. Max. speed with centrifugal pump

*5. When other kinds of fluid would be used, please consult with us.

SUMMARY OF REGULATORS

Horsepower Control

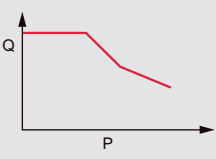
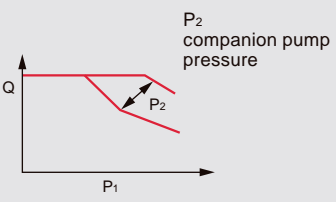
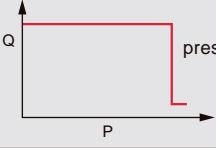
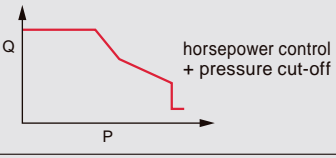
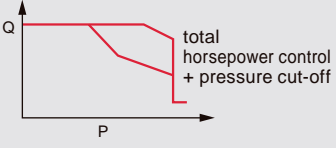
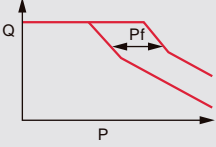
code	control type	control curve	function & features
1	constant horsepower control		According to the rise of delivery pressure of a pump, the tilting angle of the pump is automatically decreased, and the constant torque control is achieved.
2	total horsepower control		<p>1. According to the rise of delivery pressure of a pump, the tilting angle of the pump is automatically decreased, and the constant torque control is achieved. (compensation control)</p> <p>2. The total horsepower control can be achieved by decreasing the horsepower of a pump depending upon the pressure of its companion pump.</p>
4	high pressure cut-off		If the pressure rises above the set value, the pump outlet flow is automatically decreased by the pressure cut-off control.
5			
6			
9	variable horsepower control		Variable horsepower control can be obtained by supplying pilot pressure or electric current.

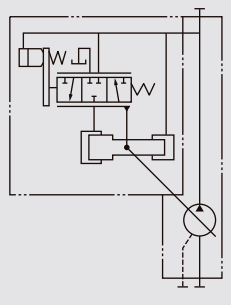
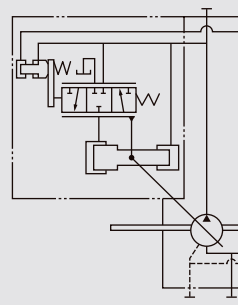
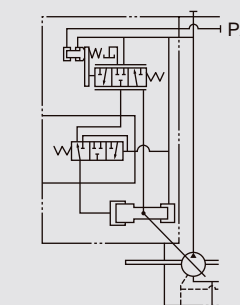
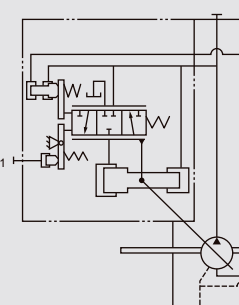
code No.	10	20	60	2P
control type	constant horsepower control	total horsepower control	total horsepower control + high-pressure cut-off	positive flow control + total horsepower control
circuit diagram				

Flow control and Horsepower control can be combined with each other. Examples of applied circuits are shown above. Please consult us about other kinds of control, if necessary.

Flow Control

code	control type	control curve	function & features
M	manual flow control	<p>Q</p> <p>S</p> <p>lever stroke</p>	With the manual control, the outlet flow can be steplessly controlled.
P	positive flow control	<p>Q</p> <p>Pi</p> <p>pilot pressure</p>	Positive flow control can be carried out by using the pilot pressure.
N	negative flow control	<p>Q</p> <p>Pi</p>	Negative flow control can be carried out by using the pilot pressure.
C	2-stage max. flow control	<p>Q</p> <p>Pm</p> <p>Pi</p>	Two-stage max. flow control can be obtained by supplying external pilot pressure. (only in negative flow control)
L	load sensing control	<p>Q</p> <p>Delta P</p> <p>Delta P = P_A - P_L</p> <p>P_A: pump pressure</p> <p>P_L: load pressure</p>	Load sensing control can be obtained.
E	electric flow control	<p>Q</p> <p>I</p> <p>electric current</p>	With the electric current, the outlet flow can be controlled.

2N	9L	2C	9N
negative flow control + total horsepower control	load sensing control + total horsepower control + variable horsepower control	negative flow control + total horsepower control + two-stage max. flow control	negative flow control + total horsepower control + variable horsepower control

DIMENSIONS

Tandem Type

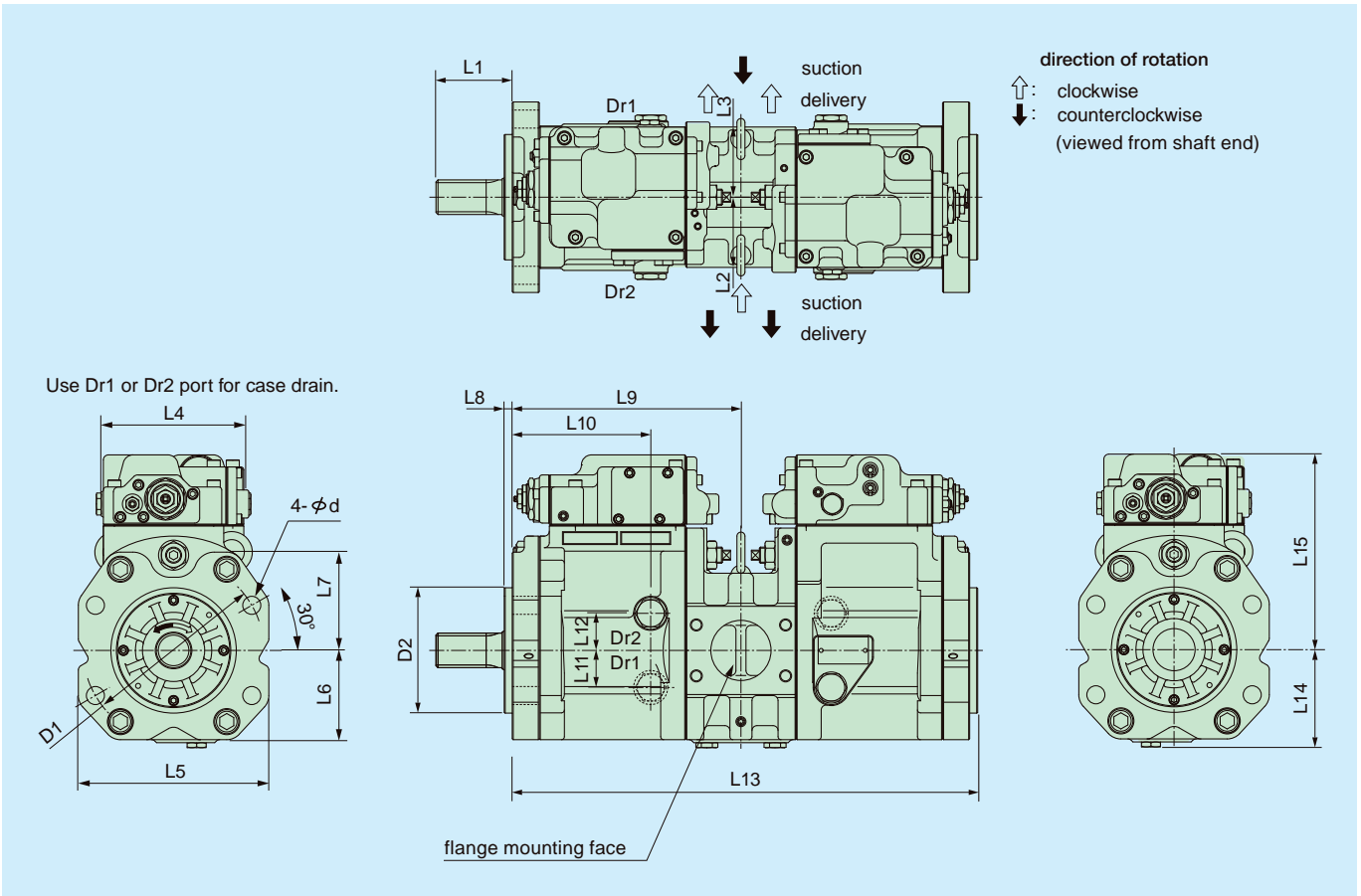

Tandem Type (with PTO)

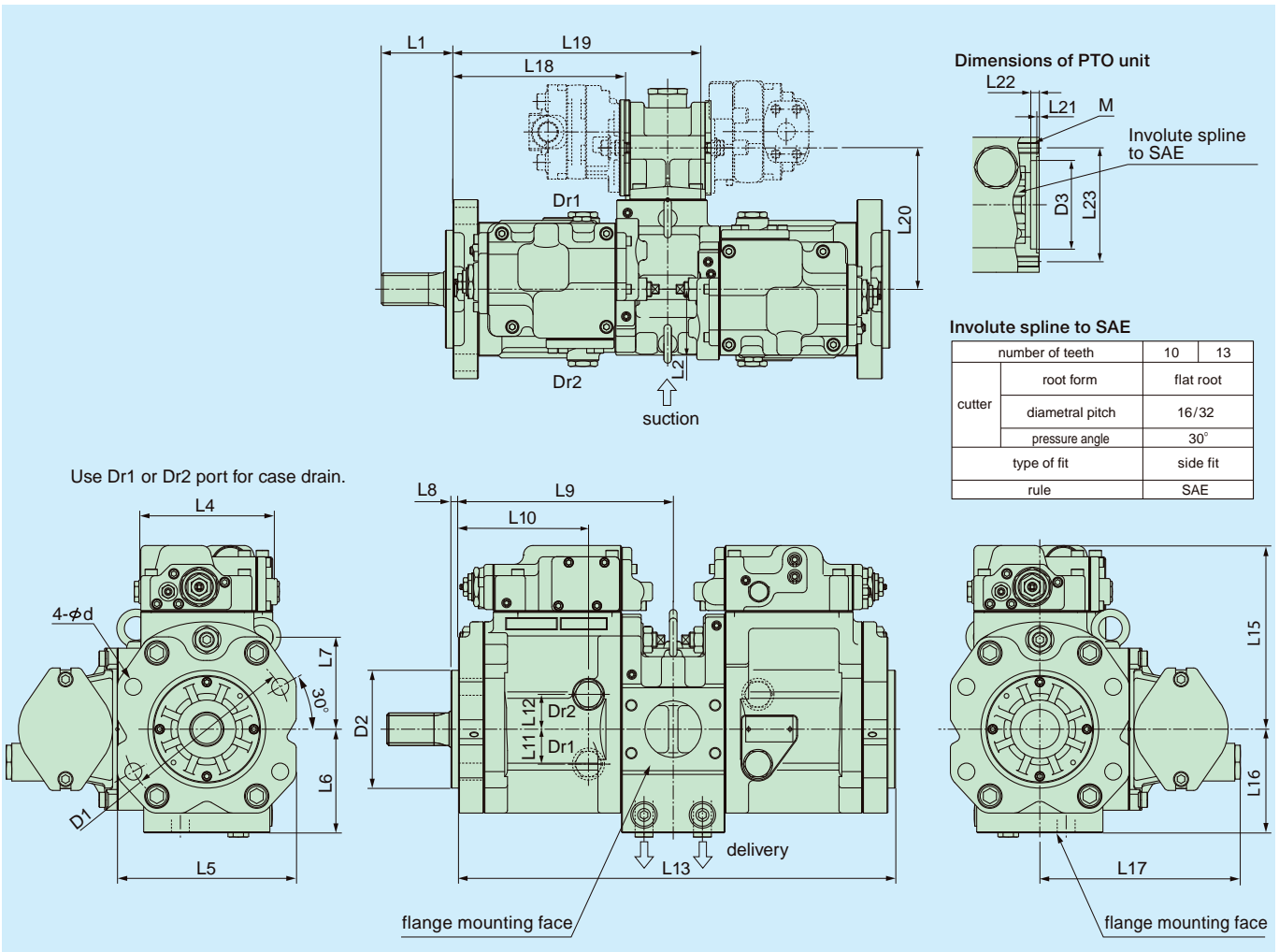

Dimensions

(mm)

size	D1	D2	D3	d	L1	L2	L3	L4	L5	L6	L7	L8	L9	L10	L11	L12	L13	L14	L15
K3V63	180	125	82.55	18	76	70	70	142	190	89	98	8	228	138	37	37	464	97	195
K3V112	224	160	82.55	22	78	80	80	142	234	100	110	8	265	167	41	41	538	109	220
K3V140	250	180	101.6	22	93	92	92	142	256	112	123	8	305	190	53	53	618	121	245
K3V280	300	200	—	26	115	150	125	142	300	127	140	8	356	203	70	70	792	150	286
K5V80	180	125	82.55	18	76	70	70	142	190	89	98	8	228	138	37	37	464	97	195
K5V140	224	160	82.55	22	78	80	80	142	234	100	110	8	265	167	41	41	538	109	220
K5V160	250	180	101.6	22	93	92	92	142	256	112	123	8	305	190	53	53	618	121	245
K5V200	250	180	101.6	22	93	92	92	142	256	112	123	8	305	190	53	53	618	121	245

size	L16	L17	L18	L19	L20	L21	L22	L23	M
K3V63	110	213	177	268	150	2.4	8	106	2-M10-25
K3V112	110	213	214	305	150	2.4	8	106	2-M10-25
K3V140	122	292	257	361	200	2.4	15	127	4-M12-22
K5V80	110	213	177	268	150	2.4	8	106	2-M10-25
K5V140	110	213	214	305	150	2.4	8	106	2-M10-25
K5V160	122	292	257	361	200	2.4	15	127	4-M12-22
K5V200	122	292	257	361	200	2.4	15	127	4-M12-22

Dimensions of shaft end

size	spec.	no. of teeth	(mm) pitch circle dia	pressure angle	module	rule
K3V63		14	29.6	30°	12/24	SAE
K3V112		14	35.0	20°	2.5	JIS B 1603
K3V140		17	42.5	20°	2.5	JIS B 1603
K3V280		18	54.0	20°	3.0	JIS B 1603
K5V80		12	30.0	20°	2.5	JIS B 1603
K5V140		17	42.5	20°	2.5	JIS B 1603
K5V160		17	42.5	20°	2.5	JIS B 1603
K5V200		17	42.5	20°	2.5	JIS B 1603

Flange mounting face for Suction port (SAE Rule)

(mm)

size	a	b	c	d—ネジ深さ depth
K3V63	50.8	88.9	φ60	M12-18
K3V112	50.8	88.9	φ60	M12-18
K3V140	61.9	106.4	φ76	M16-24
K3V280	69.8	120.7	φ89	M16-24
K5V80	50.8	88.9	φ60	M12-18
K5V140	50.8	88.9	φ60	M12-18
K5V160	61.9	106.4	φ76	M16-24
K5V200	61.9	106.4	φ76	M16-24

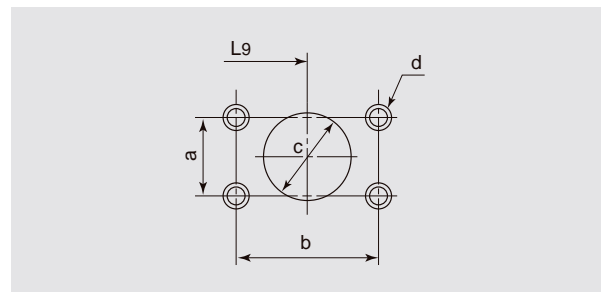

Flange mounting face for Delivery port (SAE Rule)

(mm)

size	a	b	c	d	e—ネジ深さ depth
K3V63	23.8	50.8	φ19	31.0	M10-16
K3V112	23.8	50.8	φ19	31.0	M10-16
K3V140	27.8	57.2	φ25	37.5	M12-22
K3V280	31.8	66.7	φ32	61.5	M12-20
K5V80	23.8	50.8	φ19	31.0	M10-16
K5V140	27.8	57.2	φ25	37.5	M12-22
K5V160	27.8	57.2	φ25	37.5	M12-22
K5V200	27.8	57.2	φ25	37.5	M12-22

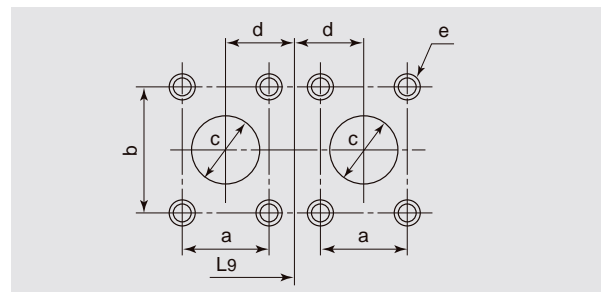

Drain port (Rule: JIS B 2351)

(mm)

size	a	b	c	d
K3V63	G 1/2	22.6	2.5	19
K3V112	G 3/4	30.8	3.5	20
K3V140	G 3/4	30.8	3.5	23
K3V280	G 3/4	30.8	3.5	23
K5V80	G 1/2	22.6	2.5	19
K5V140	G 3/4	30.8	3.5	20
K5V160	G 3/4	30.8	3.5	23
K5V200	G 3/4	30.8	3.5	23

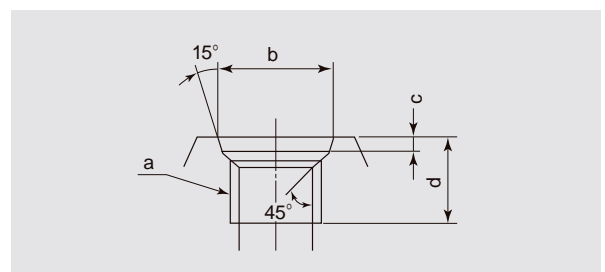

DIMENSIONS

Parallel Type

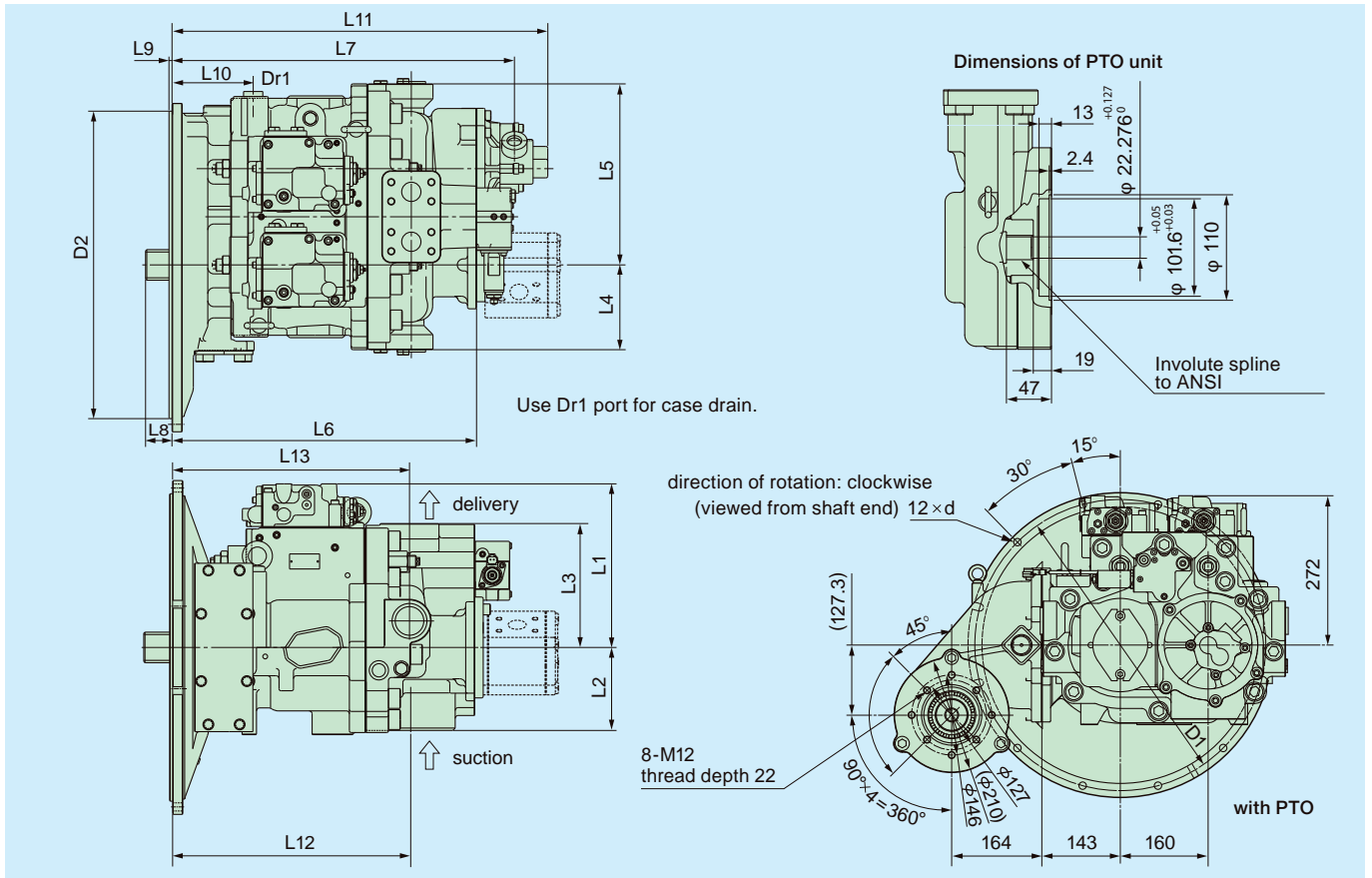

Dimensions

size	D1	D2	d	L1	L2	L3	L4	L5	L6	L7	L8	L9	L10	L11	L12	L13
K3V112	429	410	11	235	113	163	111	256	428	493	34	5	148	522	391	385
K5V160	530	511	14	272	135	206	141	301	456	519	36	5	135	575	422	398
K5V200	530	511	14	272	135	206	141	301	492	570	52	5	135	625	400	398

Dimensions of shaft end

size	spec.	no. of teeth	pitch circle dia (mm)	pressure angle	module	rule
K3V112		14	35.0	20°	2.5	JIS B 1603
K5V160		15	47.6	30°	8/16	ANSI
K5V200		15	47.6	30°	8/16	ANSI

Flange mounting face for Suction port (SAE Rule) (mm)

size	a	b	c	d-ネジ深さ depth
K3V112	50.8	88.9	φ60	M12-18
K5V160	77.8	130.2	φ102	M16-24
K5V200	69.9	120.7	φ83	M16-24

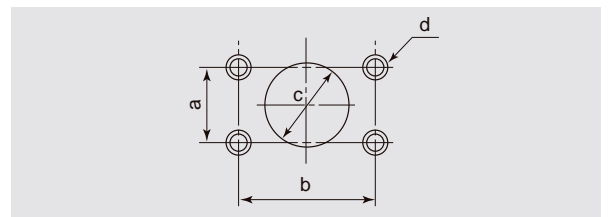

Flange mounting face for Delivery port (SAE Rule) (mm)

size	a	b	c	d	e-ネジ深さ depth
K3V112	23.8	50.8	φ19	34.0	M10-16
K5V160	31.8	66.7	φ32	41.5	M12-22
K5V200	31.8	66.7	φ32	41.5	M12-22

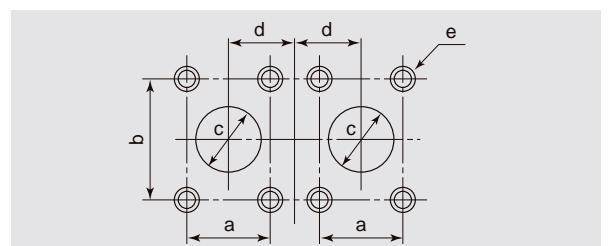

Drain port (Rule: JIS B 2351) (mm)

size	a	b	c	d
K3V112	G 3/4	30.8	3.5	20
K5V160	G 3/4	30.8	3.5	23
K5V200	G 3/4	30.8	3.5	23

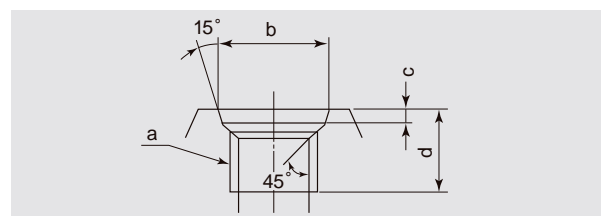

Single Type for K5V200S

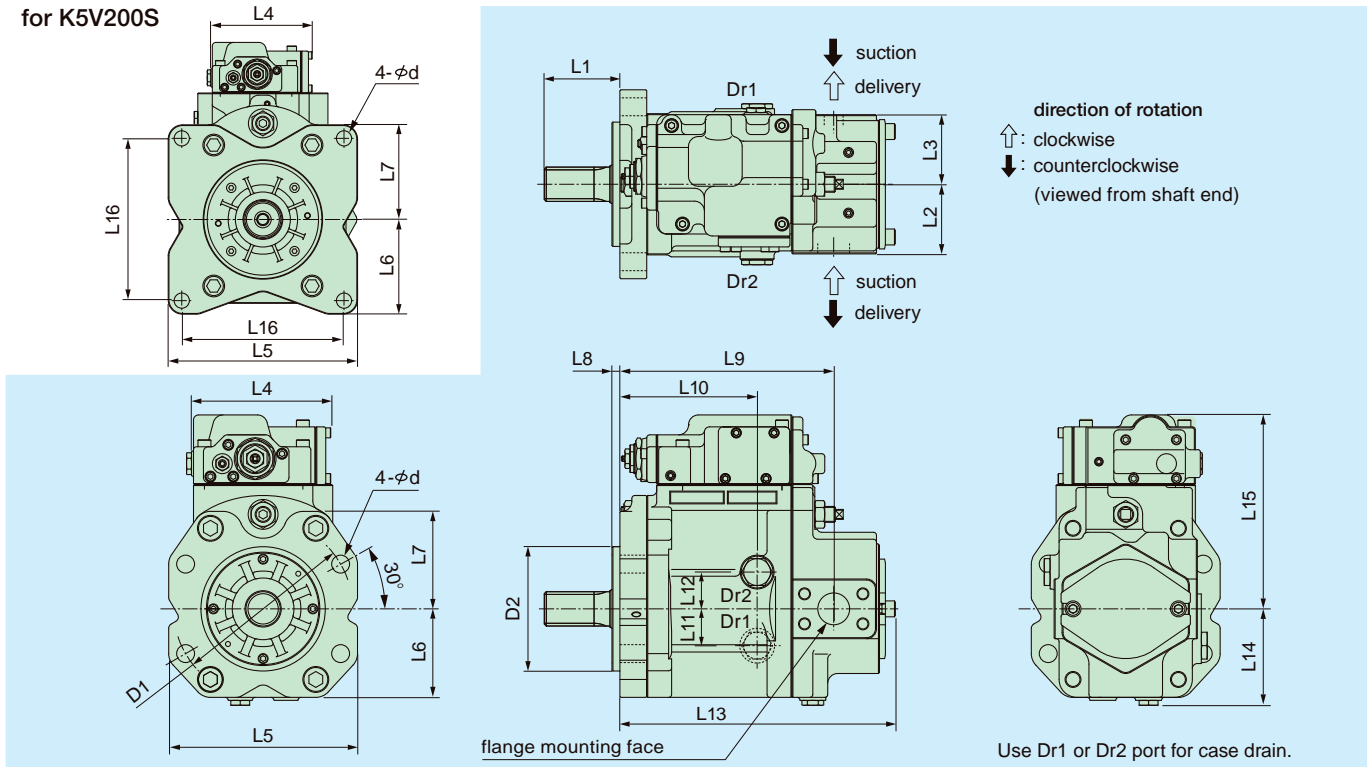

Dimensions

size	D1	D2	d	L1	L2	L3	L4	L5	L6	L7	L8	L9	L10	L11	L12	L13	L14	L15	L16
K3V63	180	125	18	76	70	70	142	190	89	98	8	210	138	37	37	277	89	195	—
K3V112	224	160	22	78	80	80	142	234	100	110	8	250	167	41	41	309	109	220	—
K3V140	250	180	22	93	92	92	142	256	112	123	8	292	190	53	53	366	121	245	—
K3V280	300	200	22	115	150	125	142	300	127	140	8	343	203	70	70	433	135	286	—
K5V80	180	125	18	76	70	70	142	190	89	98	8	210	138	37	37	277	89	195	—
K5V140	224	160	22	78	92	92	142	234	100	110	8	257	167	41	41	326	110	220	—
K5V160	250	180	22	93	92	92	142	256	112	123	8	292	190	53	53	366	121	245	—
K5V200	—	165	21	75	92	92	142	262	131	131	16	300	190	53	53	389	121	245	225

Dimensions of shaft end

size	spec.	no. of teeth	pitch circle dia (mm)	pressure angle	module	rule
K3V63		14	29.6	30°	12/24	SAE
K3V112		14	35.0	20°	2.5	JIS B 1603
K3V140		17	42.5	20°	2.5	JIS B 1603
K3V280		18	54.0	20°	3.0	JIS B 1603
K5V80		12	30.0	20°	2.5	JIS B 1603
K5V140		17	42.5	20°	2.5	JIS B 1603
K5V160		17	42.5	20°	2.5	JIS B 1603
K5V200		13	41.3	30°	8/16	SAE

Flange mounting face for Delivery port (SAE Rule)

size	a	b	c	d—depth
K3V63	23.8	50.8	φ19	M10–16
K3V112	23.8	50.8	φ19	M10–16
K3V140	31.8	66.7	φ32	M12–18
K3V280	31.8	66.7	φ32	M12–20
K5V80	27.8	57.2	φ25	M12–16
K5V140	27.8	57.2	φ25	M12–16
K5V160	36.5	79.4	φ38	M16–24
K5V200	36.5	79.4	φ38	M16–24

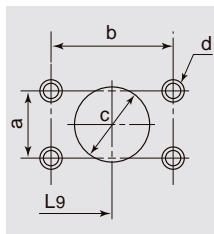

Flange mounting face for Suction port (SAE Rule)

size	a	b	c	d—depth
K3V63	30.2	58.7	φ32	M12–18
K3V112	30.2	58.7	φ38	M12–18
K3V140	50.8	88.9	φ60	M12–18
K3V280	69.9	120.7	φ80	M12–20
K5V80	35.7	69.9	φ38	M12–18
K5V140	61.9	106.4	φ76	M16–24
K5V160	61.9	106.4	φ76	M16–24
K5V200	61.9	106.4	φ76	M16–24

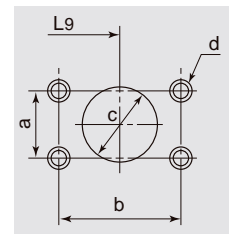

Drain port (Rule: JIS B 2351)

size	a	b	c	d
K3V63	G 1/2	22.6	2.5	19
K3V112	G 3/4	30.8	3.5	20
K3V140	G 3/4	30.8	3.5	23
K3V280	G 3/4	30.8	3.5	23
K5V80	G 1/2	22.6	2.5	19
K5V140	G 3/4	30.8	3.5	20
K5V160	G 3/4	30.8	3.5	23
K5V200	G 3/4	30.8	3.5	23

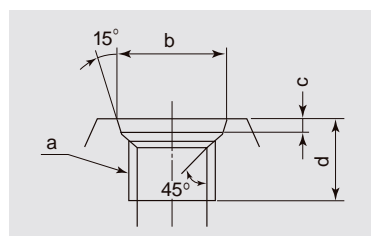

CAUTION FOR INSTRUCTION

1

Mounting Direction and Drain Piping

- The pump shaft should be mounted in the horizontal direction as shown in the figure below.
- The drain line loop must be extended above the top of the pump case.
- The upper drain port should be used, and the drain pipe size must be equal to or larger than the drain port size.
- In case of the pumps with centrifugal pump, the drain lines must be settled on each pump.

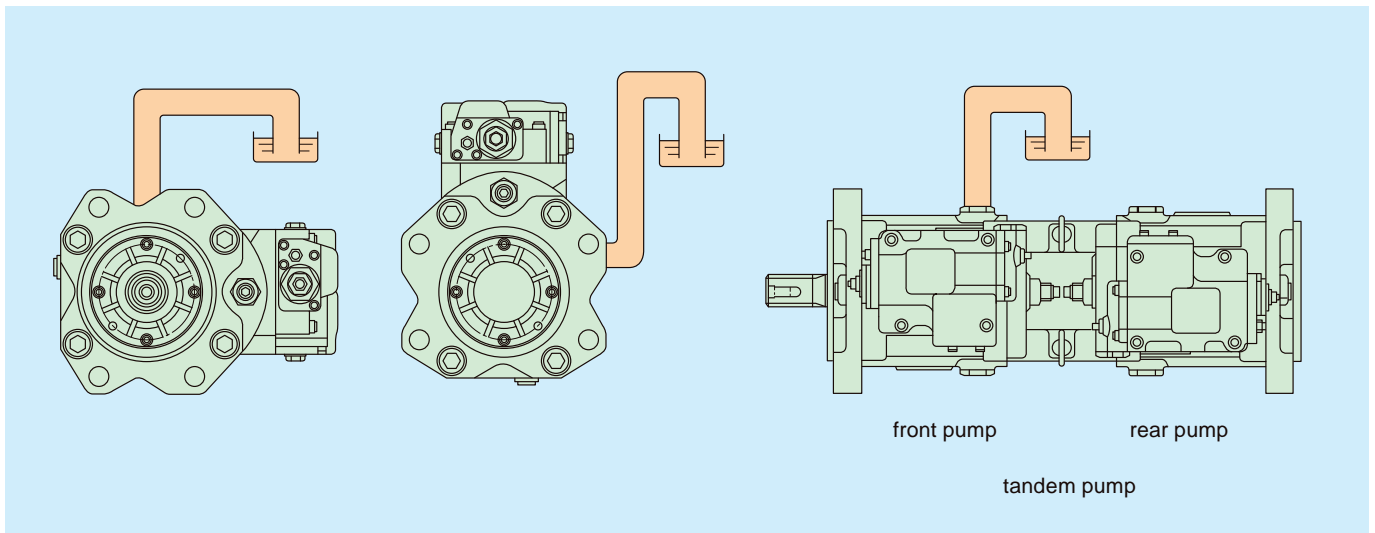

2

Filtration

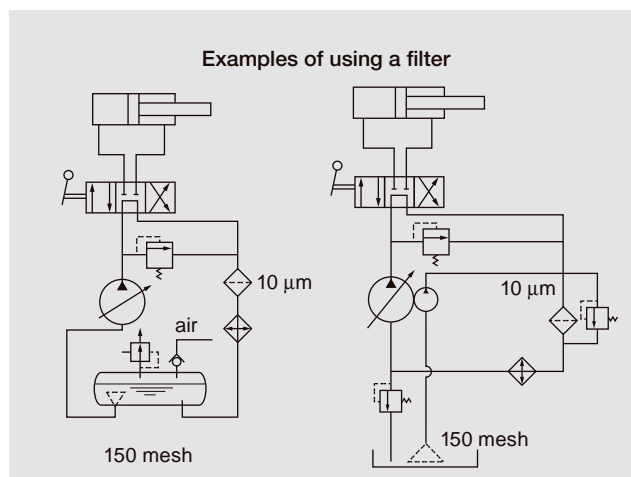

- For satisfactory service life of these pumps in application, the operating fluid should be continuously filtered to keep at least the cleanliness level of NAS 1638 Class 9. (ISO 4406-/18/15)
- A 10 µm filter must be used in the return line and a 80 ~ 150 mesh strainer in the suction lines.

3

Connection of Driving Shaft

- Please use a flexible coupling for connection of the pump drive shaft with an engine flywheel or an electric motor shaft.
- Alignment should be so carried out that the parallel error may be held with in ± 0.03 mm.
- Do not put a radial or thrust load at the shaft end.

4

Starting

- Before starting-up, fill the pump case with system fluid through the case drain connection. Case must remain full of fluid to provide internal lubrication.

5

Case Drain pressure

- Please be careful so that the drain pressure in the casing does not exceed 0.1 MPa normally and 0.4 MPa at its peak.
- A suitable size of drain hose and drain filter should be selected.

