

Part number:

HYDROMA

HYDRAULICKÉ SYSTÉMY

**HIDROMA
SYSTEMS**

UKŁADY HYDRAULICZNE

HYDROMA

ГИДРАВЛИЧЕСКИЕ СИСТЕМЫ

HC-RCX

HCRCX-04

GENERAL SPECIFICATIONS - CARATTERISTICHE GENERALI

Standard working conditions

- MAXIMUM INPUT PRESSURE **1450 psi**
- MAXIMUM BACK PRESSURE ON TANK LINE **44 psi**
- OIL INPUT CAPACITY **4,2 GPM**
- HYSTERESIS **7,25 psi**
- HYDRAULIC FLUID **mineral oil**
- FLUID TEMPERATURE RANGE **-20 + 80 °C**
- FLUID VISCOSITY RANGE **10 ÷ 300 Cst**
- RECOMMENDED FILTRATION **25 µ Absolute**
- RECOMMENDED OPERATING PIPES **Ø8 mm rigid
1/4" BSP flexible**
- LEAKAGE **3.cc/min (50 bar)**

Condizioni di lavoro standard

- PRESSIONE MAX IN ALIMENTAZIONE **100 bar**
- PRESSIONE MAX IN SCARICO **3 bar**
- PORTATA OLIO IN ALIMENTAZIONE **16 l/min**
- ISTERESI **0,5 bar**
- FLUIDO IDRAULICO **olio minerale**
- CAMPO DI TEMPERATURA DEL FLUIDO **-20 +80 °C**
- CAMPO DI VISCOSITÀ DEL FLUIDO **10 ÷ 300 Cst**
- GRADO DI FILTRAZIONE CONSIGLIA TO . **25 µ Absolute**
- TUBAZIONI DI PILOT AGGIO CONSIGLIA TE **Ø8 mm rigid
1/4" BSP flessibile**
- TRAFILAMENTO **3.cc/min (50 bar)**

Technical specifications

- BODY **CAST IRON**
- SURFACE COATING **ZINC PLATED**
- PLUNGER **STAINLESS STEEL**
- PLUNGER GUIDE **BRASS**

Caratteristiche tecniche

- CORPO **GHISA**
- PROTEZIONE SUPERFICIALE **ZINCATURA**
- SPINTORE **ACCIAIO INOX**
- GUIDA SPINTORE **OTTONE**

Unit of measure - Conversion factors

Systems / Unit	METRIC	BSP
LENGTH	1 mm = 0,0394 in	1 in = 25,4 mm
MASS	1 kg = 2,205 lb	1 lb = 0,4536 kg
FORCE	1 Nm = 0,1020 kgf	1 kgf = 9,8067 Nm
VOLUME	1 l = 0,2200 gal UK 1 l = 0,2642 gal US	1 gal UK = 4,546 l 1 gal US = 3,785 l
PRESSURE	1 bar = 100000 Pa 1 bar = 14,5 psi	1 Pa = 0,00001 bar 1 psi = 0.0689 bar

Unità di misura - Fattori conversione

Sistemi / Unità	METRICO	BRITANNICO
LUNGHEZZA	1 mm = 0,0394 in	1 in = 25,4 mm
MASSA	1 kg = 2,205 lb	1 lb = 0,4536 kg
FORZA	1 Nm = 0,1020 kgf	1 kgf = 9,8067 Nm
VOLUME	1 l = 0,2200 gal UK 1 l = 0,2642 gal US	1 gal UK = 4,546 l 1 gal US = 3,785 l
PRESSIONE	1 bar = 100000 Pa 1 bar = 14,5 psi	1 Pa = 0,00001 bar 1 psi = 0.0689 bar

If using hydraulic remote controls HC-RCX with different technical specifications or with special functions that are not shown in our catalogue, you are kindly requested to contact our technical and sales department.

Per l'impiego dei telecomandi HC-RCX con diverse caratteristiche tecniche o con particolari opzioni non a catalogo interpellare il nostro servizio tecnico-commerciale.

DIMENSIONS - DIMENSIONI

**Overall dimensions
Ingombro dimensionale:**

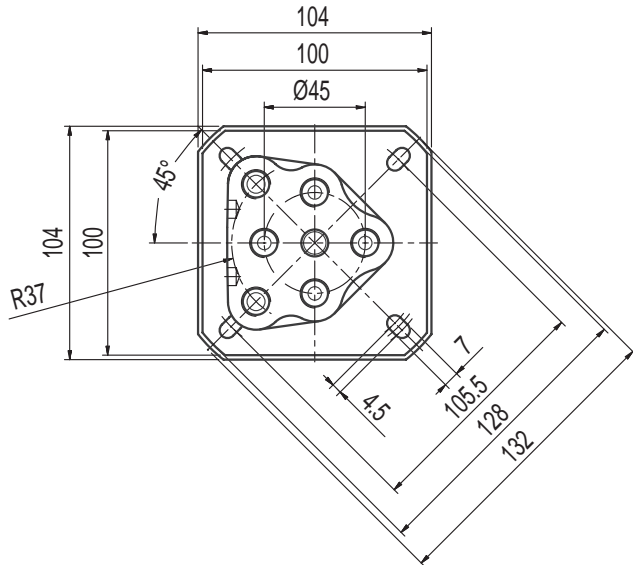

**Holder hole dimensions
Dimensione foro alloggiamento**

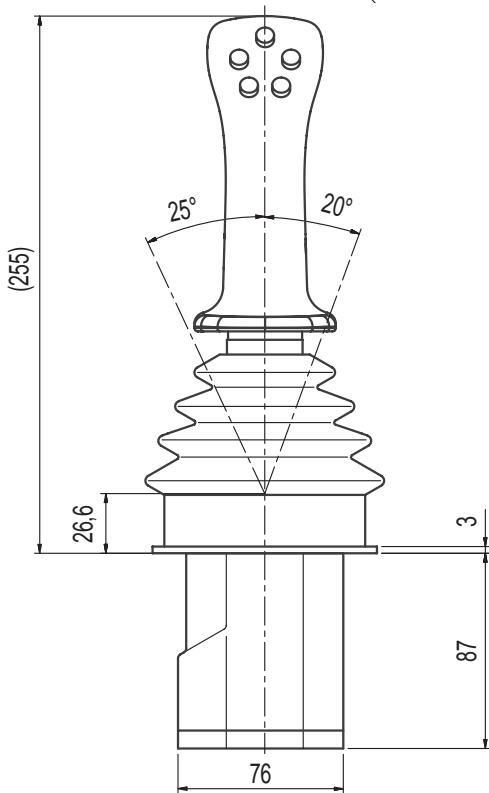
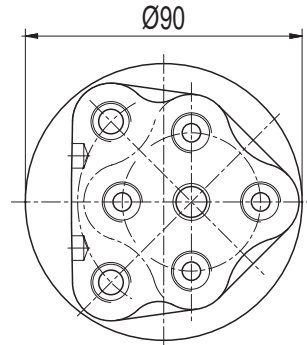

**Hydraulic diagram
Schema idraulico**

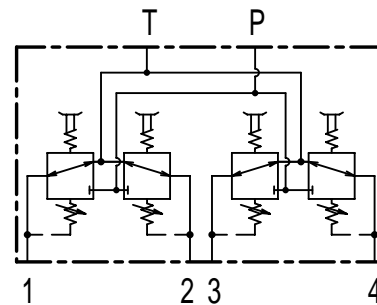

**Weight
Peso**

Weight	6,39 lb
Massa (peso)	2,90 Kg

Order example

Esempio di ordinazione

HC-RCX

01

A01

MA

F-05F-00R-2

WF53

RA G02

product
prodotto

A

pag. 6

B

pag. 7

C

pag. 10

D

pag. 12

E

pag. 15

F

pag. 17

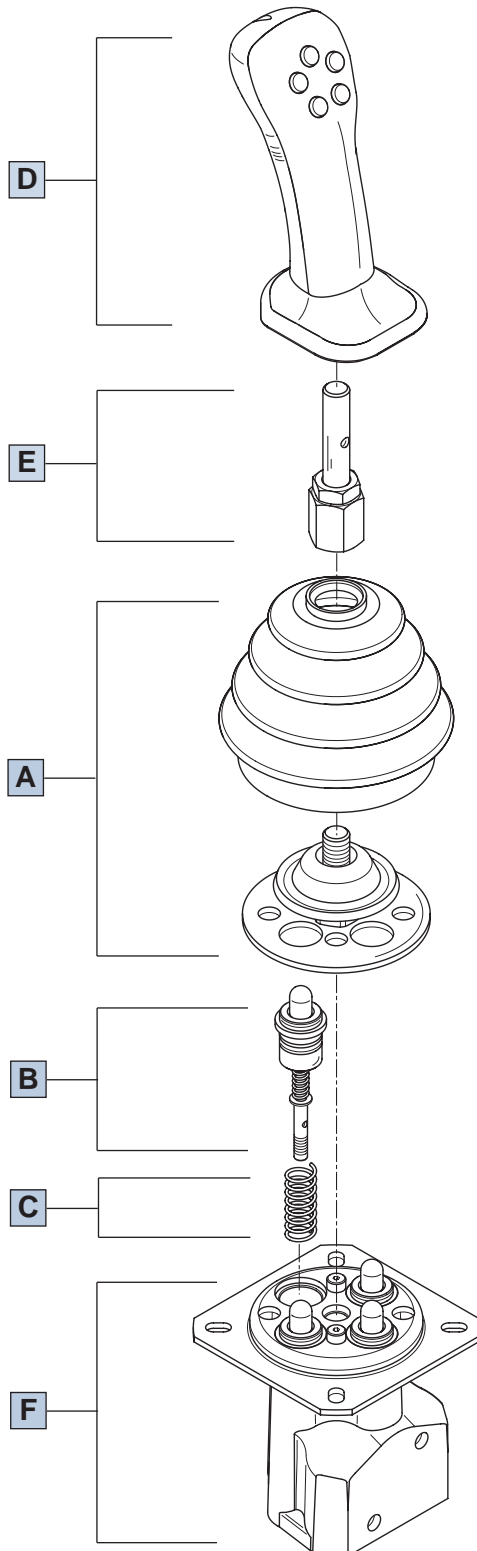

**A CONTROL
COMANDO**

01 = control type / tipologia comando.....pag. 6

**B METERING CURVE
CURVA DI REGOLAZIONE**

A01 = curve type / tipologia curvapag. 7

**C RETURN SPRING
MOLLA RICHIAMO**

MA = return spring type
tipologia molla richiamopag. 10

NOTE: ordering row B and C, must be repeated for each port

NOTA: le sigle dei riferimenti B e C, devono essere ripetute per ogni utilizzo

**D HANDLE
IMPUGNATURA**

F = handle type / tipologia impugnaturapag. 12

05F = front buttons
allestimento pulsanti anteriori.....pag. 13

00R = rear buttons
allestimento pulsanti posteriori.....pag. 13

2 = handle position
posizionamento impugnaturapag. 14

**E LEVER ROD
ASTA LEVA**

WF = lever rod typ / tipologia asta levapag. 15

53 = lever rod lenght / lunghezza asta levapag. 15

**F BODY ARRANGEMENT
ALLESTIMENTO CORPO**

RA = body specification
configurazione corpopag. 17

G02 = thread / filettatura corpopag. 17

Classification

Classificazione

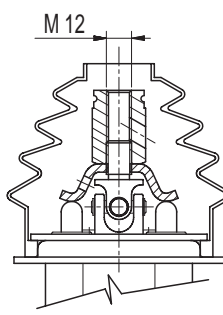
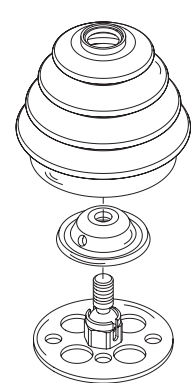
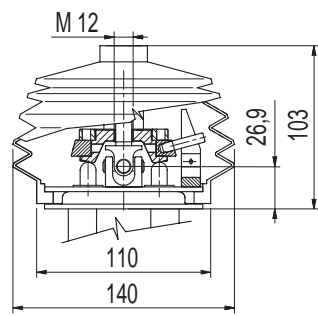
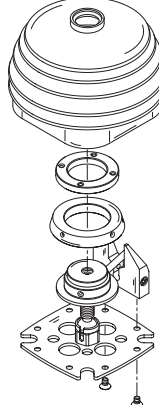
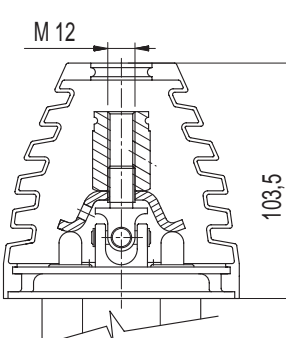
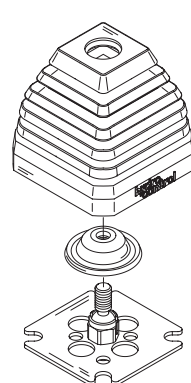
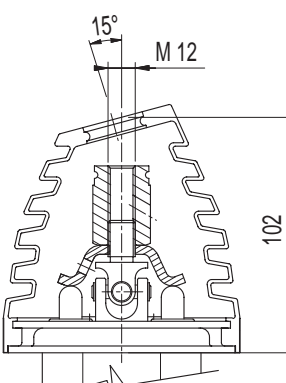
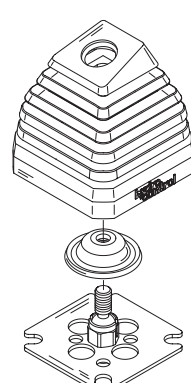
DIMENSIONS DIMENSIONI	LAYOUT CONFIGURAZIONE	DESCRIPTION + CODE DESCRIZIONE + SIGLA
		<p><i>Return spring in neutral</i></p> <p>Ritorno a molla in posizione neutra</p> <p style="text-align: center;">01</p>
		<p><i>Spring return in neutral with detent in only one service port</i></p> <p>Ritorno a molla in posizione neutra con ritenuta su un solo utilizzo</p> <p style="text-align: center;">02</p>
		<p><i>Spring return in neutral with square bellows for straight lever rod</i></p> <p>Ritorno a molla in posizione neutra con soffiello quadrato per asta leva dritta</p> <p style="text-align: center;">03</p>
		<p><i>Spring return in neutral with square bellows for bent lever rod</i></p> <p>Ritorno a molla in posizione neutra con soffiello quadrato per asta leva piegata</p> <p style="text-align: center;">04</p>

Metering curve

Curva di regolazione

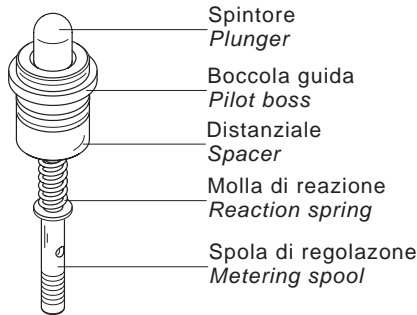
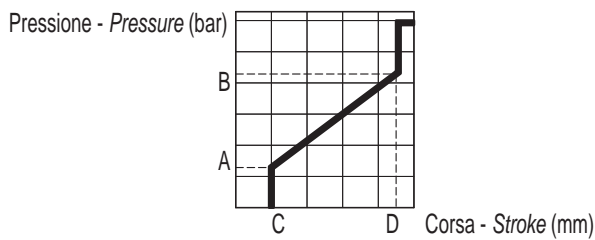

DIAGRAM - GRAFICO



DESCRIPTION - DESCRIZIONE

Linear metering curve with step
Curve di regolazione con caratteristica lineare con step

CURVE - CURVA
A

CODE SIGLA	A01	A02	A03	A04	A05	A06	A07	A08	A09	A10	A11	A12	A13	A14	A15	A16	A17	A18	A19	A20	
PRESSURE PRESSIONE	A	5,8	5	2	6	0	4	5	2	5	2	4	11,5	10	7	7,5	6	0	4	6	8
	B	19,5	25	13	40	4	17	15	18	20	8	10	32	20	17	29	22	20	16	20,6	28
STROKE CORSA	C	1,5	1,5	1,5	1,5	1,5	1,5	1,5	1,5	1,5	1,5	1,5	1,5	1,5	1,5	1,5	1,5	1	1,5	1,5	1,5
	D	7,5	7,5	7,5	7,5	7,5	7,5	7,5	7,5	6	7,5	7,5	7,5	7,5	7,5	7,5	7,5	7,5	7	7	7,5

CODE SIGLA	A21	A22	A23	A24	A25	A26	A27	A28	A29	A30	A31	A32	A33	A34	A35	A36	A37	A38	A39	A40	
PRESSURE PRESSIONE	A	5	5,8	6,8	5,8	4,5	2,8	8	3	8	5,8	5,7	7	10,8	0	5,8	7,4	7,1	7,5	6,6	6,5
	B	20,5	18,3	23,5	19,2	14,5	20,8	34	16,2	27,6	15,5	25,7	15,5	27,5	28	24	21	18,8	17,7	16,4	11,6
STROKE CORSA	C	1,5	1,5	1	1,5	1	1,5	1,5	1,5	1,5	1,5	1,5	1,2	1	1,5	1,5	1,5	1,5	1,5	1,5	1,5
	D	8	8	7,5	9,5	5	10	7,5	7,5	10	7,5	7,5	7,5	7,5	7,5	9,5	7,5	7	7,5	7,5	7,5

CODE SIGLA	A41	A42	A43	A44	A45	A46	A47	A48												
PRESSURE PRESSIONE	A	5,9	6,6	3	14,5	8,7	4	14,7	5											
	B	17,4	16,3	22,2	26,9	39,2	22	28,4	74											
STROKE CORSA	C	1,5	1,5	1,5	1	1,5	1,5	1,5	1											
	D	7,5	9,5	7,5	7,5	7,5	7,5	7,5	7,5											

CODE SIGLA																				
PRESSURE PRESSIONE	A																			
	B																			
STROKE CORSA	C																			
	D																			

METERING CURVE - CURVA DI REGOLAZIONE

DIAGRAM - GRAFICO

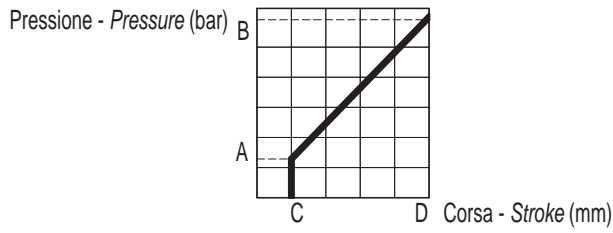

DESCRIPTION - DESCRIZIONE

Linear metering curve without step
Curve di regolazione con caratteristica lineare senza step

CURVE - CURVA
B

CODE SIGLA	B01	B02	B03	B04	B05	B06	B07	B08	B09	B10	B11	B12	B13	B14	B15	B16	B17	B18	B19	B20
PRESSURE PRESSIONE																				
A	5	5	5	2	7,5	5	4	3	6	2	7,2	8,3	8	6	10,4	6,5	2,1	5,8	6,5	2
B	22	19	16	16,5	32,5	20	10,5	14,5	24,3	19,3	21,3	22,4	22,8	23	25,5	12	20,3	27	12	8,5
STROKE CORSA																				
C	1,5	1,5	1,5	1,5	1	1	1,5	1,5	1	1,5	1	1	1	1,5	1	1	1	1,5	1,5	1,5
D	8	8	8	8	8	8	8	8	8	8	7,5	7,5	7,5	8	7,5	8	8	8	8	8

CODE SIGLA	B21	B22	B23	B24	B25	B26														
PRESSURE PRESSIONE																				
A	2	5,8	4	10,2	4,5	7,3														
B	13,7	16,4	18	25,1	23,9	40,5														
STROKE CORSA																				
C	1,5	1,2	1,5	1	1,5	1,5														
D	8	7,7	8	8	8	8														

METERING CURVE - CURVA DI REGOLAZIONE

DIAGRAM - GRAFICO

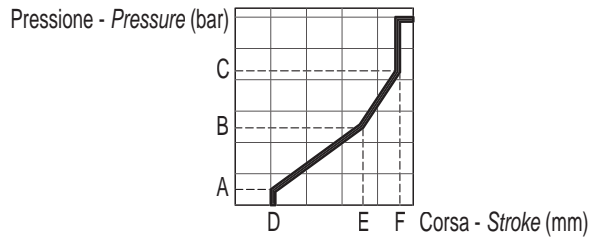

DESCRIPTION - DESCRIZIONE

Broke line metering curve with step
Curve di regolazione con caratteristica spezzata con step

CURVE - CURVA
C

CODE SIGLA		C01	C02	C03	C04	C05												
PRESSURE PRESSIONE	A	2	3	7	7	5												
	B	6	7	18	18	11												
	C	15	16	27	27	18												
STROKE CORSA	D	1,5	1,5	0,5	0,5	1												
	E	5	5	4,8	6,3	5												
	F	7,5	7,5	6,5	8	7,5												

DIAGRAM - GRAFICO

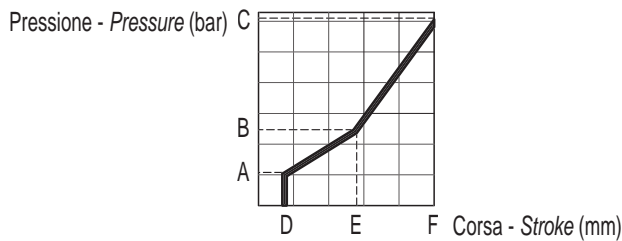

DESCRIPTION - DESCRIZIONE

Broke line metering curve without step
Curve di regolazione con caratteristica spezzata senza step

CURVE - CURVA
D

CODE SIGLA		D01	D02															
PRESSURE PRESSIONE	A	2	4,2															
	B	6	9															
	C	15	22															
STROKE CORSA	D	1,5	1															
	E	5	5															
	F	8	8															

RETURN SPRING - MOLLA RICHIAMO

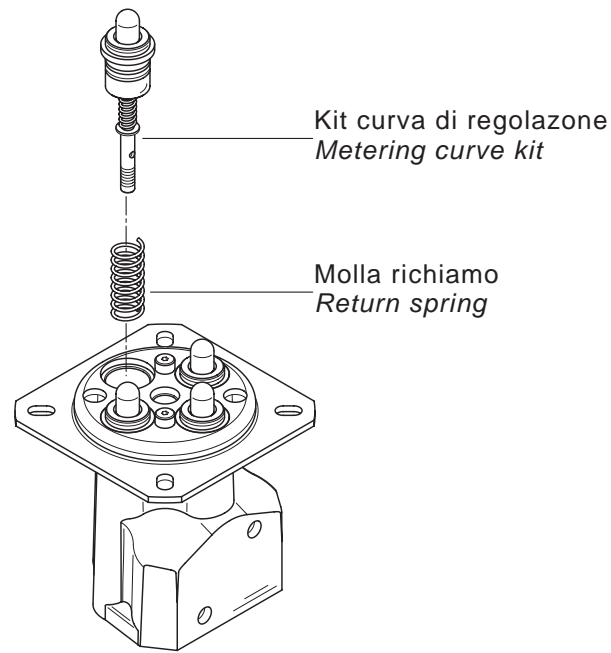

CODE - SIGLA	MA	MB	MC	MD
Preload Precarico	3 kgf 29,5 N	1,4 kgf 14,6 N	7,5 kgf 73,5 N	10 kgf 98 N
End stroke load Carico a fine corsa	4,5 kgf 44 N	2,8 kgf 29,4 N	13,8 kgf 135,5 N	19 kg 186 N

Classification

Classificazione

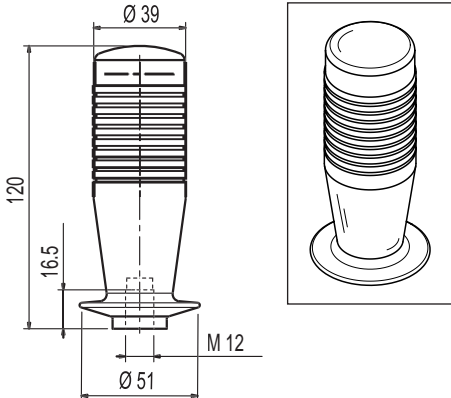
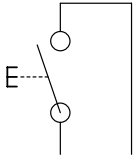
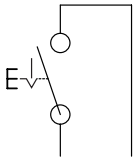
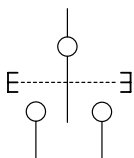
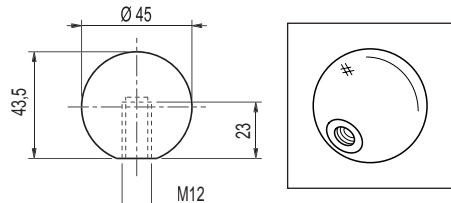
CODE SIGLA	DIAGRAM SCHEMA	OVERALL DIMENSIONS INGOMBRO DIMENSIONALE	DESCRIPTION DESCRIZIONE
A			<i>Without micro-switch (standard)</i> Senza contatto elettrico (standard)
B			<i>With micro-switch to close</i> Con microinterruttore a 1 via
C			<i>With micro-switch to close with detent</i> Con microinterruttore a 1 via con aggancio
D			<i>With dual micro-switch</i> Con microinterruttore a 2 vie
K			<i>Spherical handle</i> Sferica

HANDLES MICROSWITCH
BREAKING B C D

- DIRECT CURRENT load resistive 4.8A/30 VDC
- ALTERNATING CURRENT . . . load resistive 1.5A/250 VAC
- PROTECTION IP 40

POTERE DI ROTTURA
MICROINTERRUTTORI IMPUGNATURE B C D

- CORRENTE CONTINUA carico resistivo 4.8A/30 VDC
- CORRENTE ALTERNATA carico resistivo 1.5A/250 VAC
- GRADO DI PROTEZIONE IP 40

ERGONOMIC HANDLE - IMPUGNATURA ERGONOMICA

Ergonomic handle

This handle has been designed to be used on our remote controls type RCX.

Its ergonomics, the accurate buttons position and dimensions make its use comfortable and restful. It can be supplied with 7 microswitches in different combinations together with a push button for safety.

Technical specifications

BUTTONS COLOURS:

A	red
B-C	yellow
D-E	green
F-G	grey
H (push button for safety)	black

HANDLE PROTECTION **IP 65**

CABLE SECTION **0.5 mm²**

USEFUL CABLE LENGHT **700 mm**

MICRO-SWITCHES SPECIFICATIONS CURRENT:

Direct current load resistive **5 A 30 VDC**

Direct current load inductive **3 A 250 VDC**

Alternating current load resistive **5 A 30 VAC**

Alternating current load inductive **2 A 250 VAC**

Impugnatura ergonomica

Questa impugnatura è stata espressamente studiata per essere utilizzata sui manipolatori di nostra produzione RCX. Grazie alla sua ergonomia e un accurato posizionamento e dimensionamento dei pulsanti rende il suo utilizzo più confortevole e riposante. Può essere equipaggiata con 7 microinterruttori in varie combinazioni più un sensore per "l'uomo presente".

Caratteristiche tecniche

COLORAZIONE PULSANTI:

A	rosso
B-C	giallo
D-E	verde
F-G	grigio
H (uomo presente)	nero

PROTEZIONE IMPUGNATURA **IP 65**

SEZIONE CAVO **0.5 mm²**

LUNGHEZZA UTILE DEL CAVO **700 mm**

CARATTERISTICHE MICROINTERRUTTORI:

Corrente continua carico resistivo **5 A 30 VDC**

Corrente continua carico induttivo **3 A 250 VDC**

Corrente alternata carico resistivo **5 A 30 VAC**

Corrente alternata carico induttivo **2 A 250 VAC**

Overall dimensions

Ingombro dimensionale

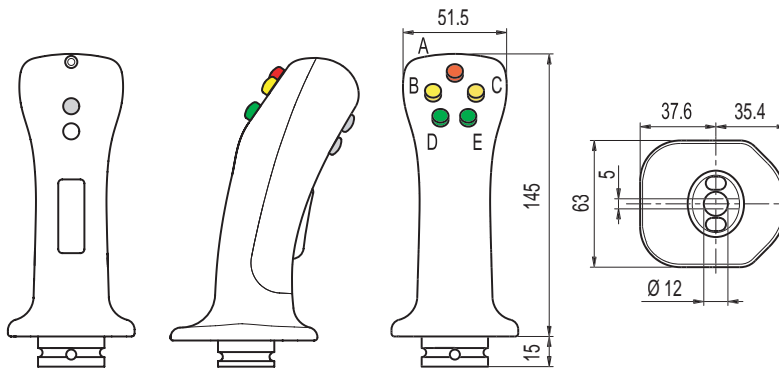

Order example

Esempio di ordinazione

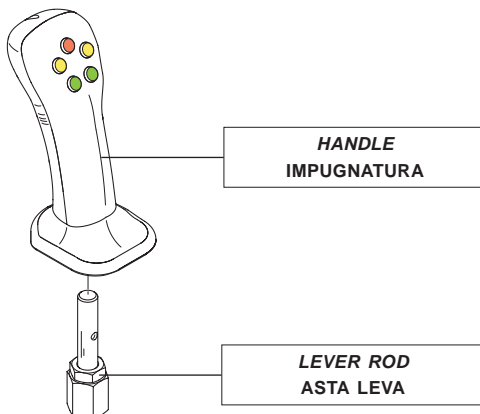

- F** handle type / tipo di impugnatura
- 05F** front buttons / allestimento pulsanti anteriori
- 00R** rear buttons / allestimento pulsanti posteriori
- 2** handle position / posizionamento impugnatura
- WF** level type / tipo asta leva
- 53** lever rod length / lunghezza asta leva

Front buttons
Allestimento pulsanti anteriori

CODE SIGLA	DESIGN DISEGNO	DIAGRAM SCHEMA
00F		
01F		
02F		
03F		
04F		
05F		

Rear buttons
Allestimento pulsanti posteriori

CODE SIGLA	DESIGN DISEGNO	DIAGRAM SCHEMA
00R		
01R		
02R		
03R		
04R		
05R		

ERGONOMIC HANDLE - IMPUGNATURA ERGONOMICA

Handle position
compared to ports

Posizionamento impugnatura
rispetto agli utilizzi

CODE
SIGLA 1

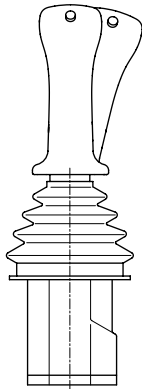
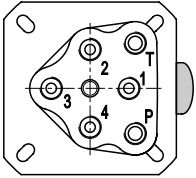

CODE
SIGLA 5

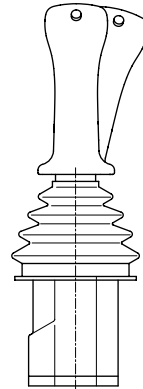
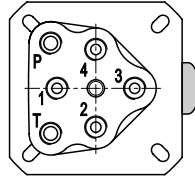

CODE
SIGLA 2

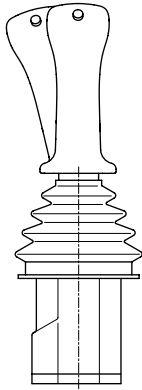
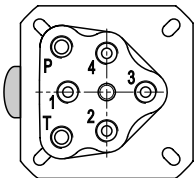

CODE
SIGLA 6

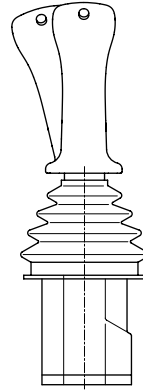
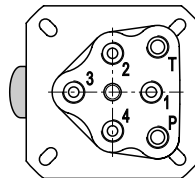

CODE
SIGLA 3

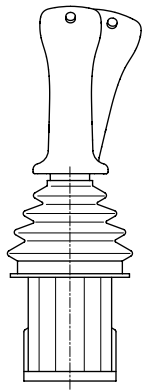
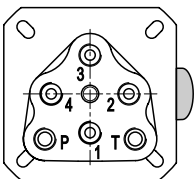

CODE
SIGLA 7

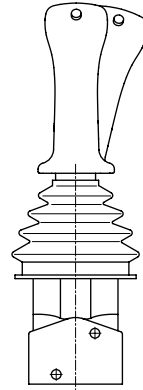
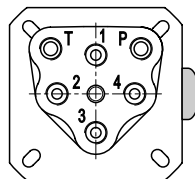

CODE
SIGLA 4

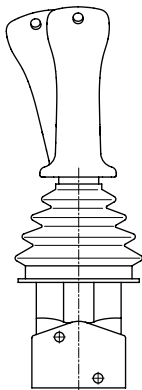
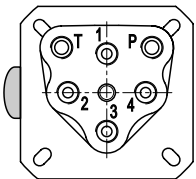

CODE
SIGLA 8

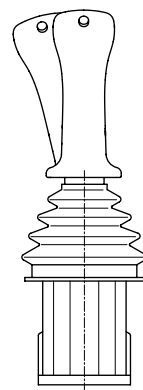
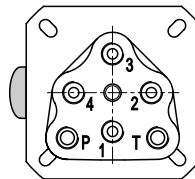

Lever rods for handles type A-B-C-D

Aste leva per impugnature tipo A-B-C-D

CODE SIGLA	OVERALL DIMENSIONS INGOMBRO DIMENSIONALE	TO USE ONLY WITH FOLLOWING CONTROLS UTILIZZABILE SOLO SU COMANDI
---------------	---	---

WA27

01

02

WB52

01

02

WD32

01

02

Lever rods for handles type K

Aste leva per impugnature tipo K

CODE SIGLA	OVERALL DIMENSIONS INGOMBRO DIMENSIONALE	TO USE ONLY WITH FOLLOWING CONTROLS UTILIZZABILE SOLO SU COMANDI
---------------	---	---

WE100

01

02

LEVER RODS - ASTE LEVA

Lever rods for handle type F

Aste leva per impugnatura tipo F

CODE
SIGLA

OVERALL DIMENSIONS
INGOMBRO DIMENSIONALE

TO USE ONLY WITH FOLLOWING CONTROLS
UTILIZZABILE SOLO SU COMANDI

WF53

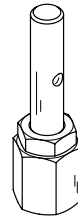
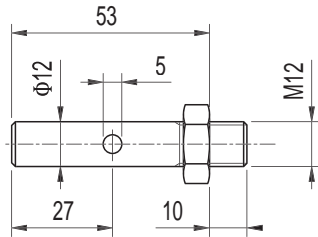

01

02

03

WG51

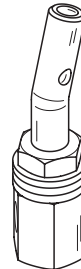
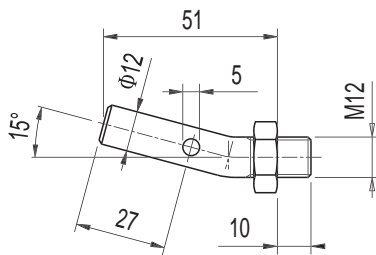

01

02

04

WH48

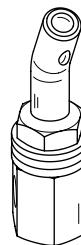
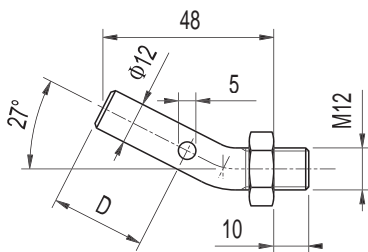

01

02

04

Classification

Classificazione

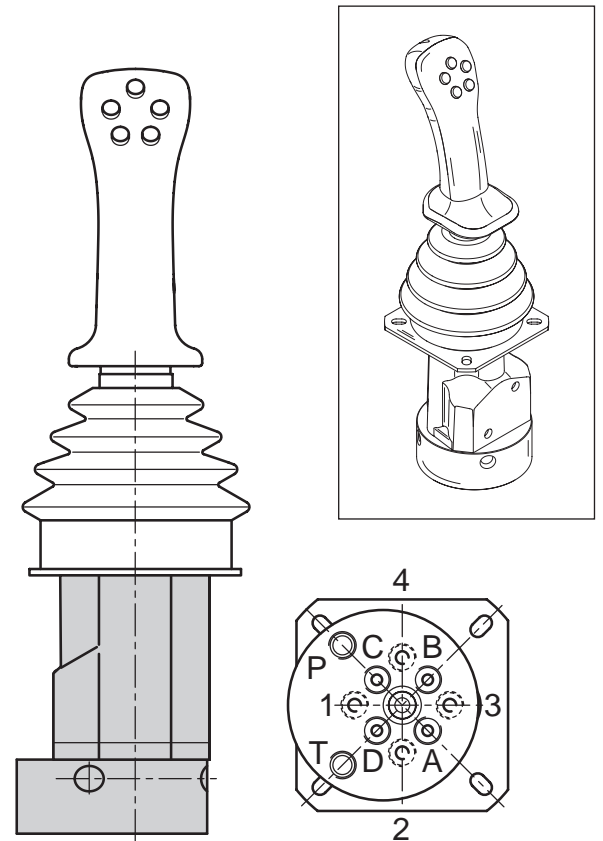
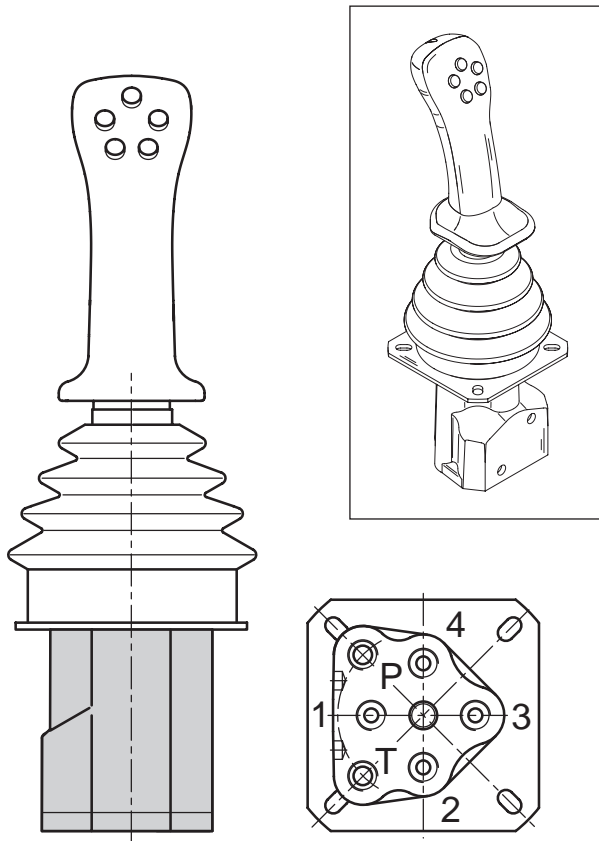

HYDRAULIC DIAGRAM
SCHEMA IDRAULICO

HYDRAULIC DIAGRAM
SCHEMA IDRAULICO

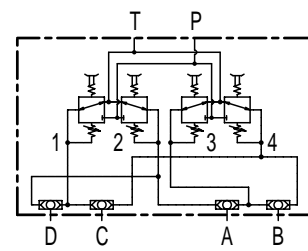
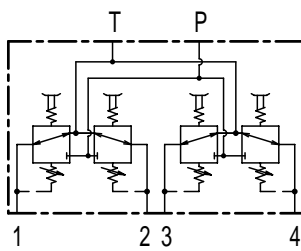

CODE SIGLA	DESCRIPTION DESCRIZIONE	SERVICE FILETTATURA	CODE SIGLA
RA	Standard body Corpo standard	1/4" BSP	G02
		9/16".18 UNF	U02

CODE SIGLA	DESCRIPTION DESCRIZIONE	SERVICE FILETTATURA	CODE SIGLA
RB	Body with shuttle valve for translation Corpo con blocco per comando traslazione	1/4" BSP	G02
		9/16".18 UNF	U02

STANDARD LAYOUT DRAWINGS - SCHEMI TIPICI DI INSTALLAZIONE

HYDRAULIC REMOTE CONTROL INPUT WITH AUXILIARY PUMP
ALIMENTAZIONI TELECOMANDI CON POMPA AUSILIARIA

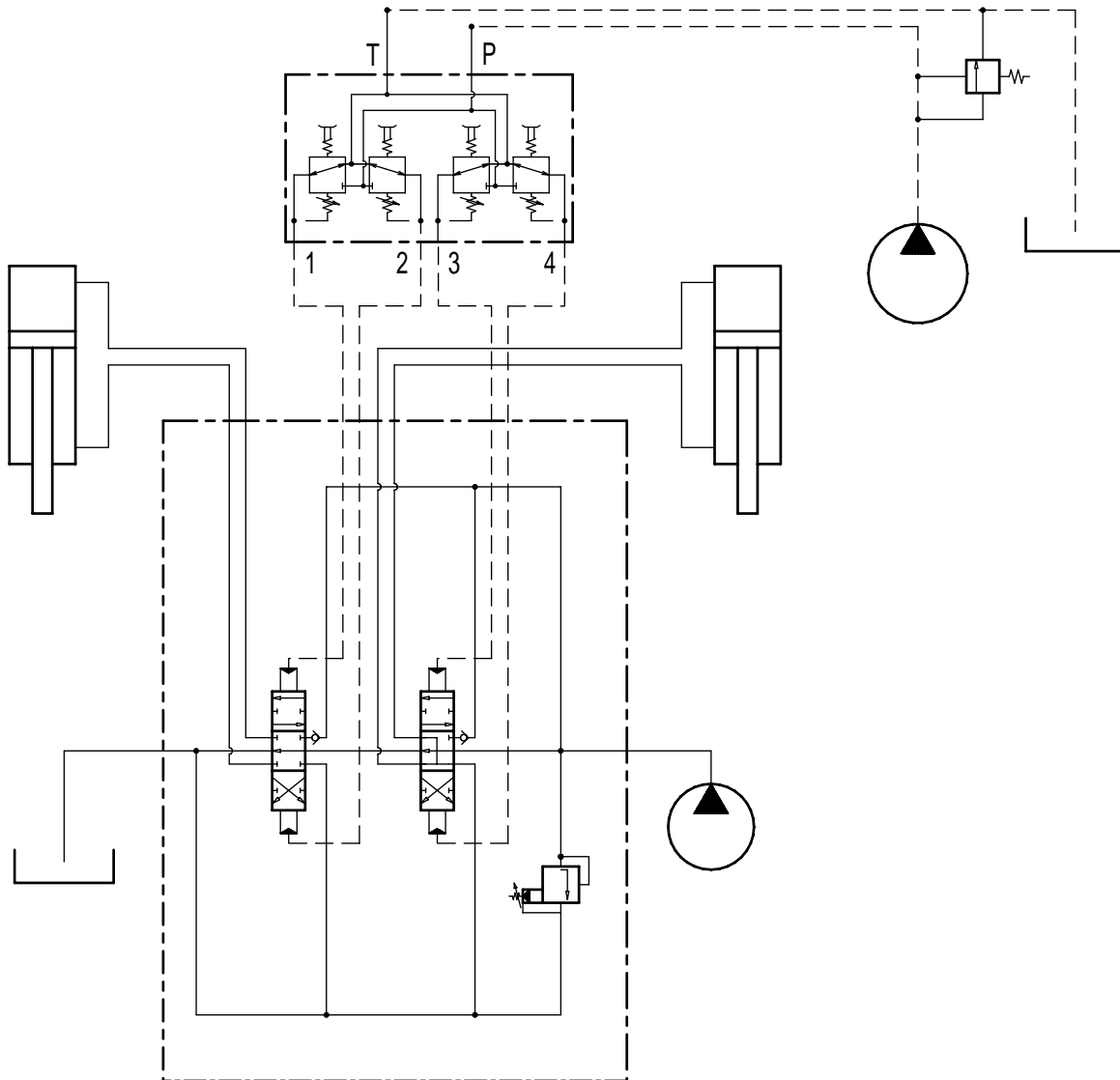

STANDARD LAYOUT DRAWINGS - SCHEMI TIPICI DI INSTALLAZIONE

HYDRAULIC REMOTE CONTROL INPUT WITH SUPPLY UNIT COMING FROM THE MAIN CIRCUIT
ALIMENTAZIONE TELECOMANDI CON UNITÀ DI ALIMENTAZIONE IN DERIVAZIONE DAL CIRCUITO PRINCIPALE

