

Part number:

025-10127

HYDROMA

HYDRAULICKÉ SYSTÉMY

**HIDROMA
SYSTEMS**

UKŁADY HYDRAULICZNE

HYDROMA

ГИДРАВЛИЧЕСКИЕ СИСТЕМЫ

Coils - Connectors

COIL S8-356 - CLASS H - 20 W

OD.02.17 - X - Y - Z

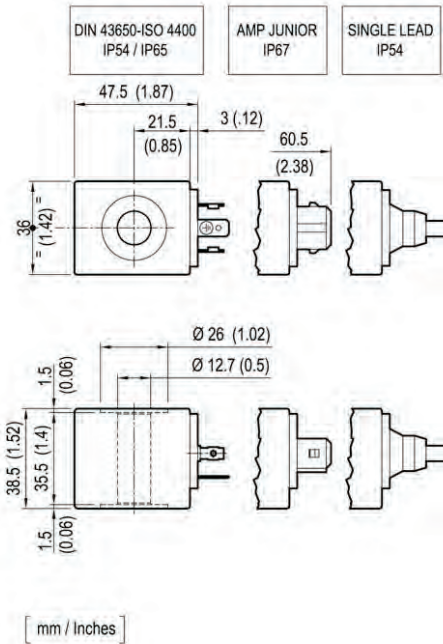

TECHNICAL DATA

Weight: 0.18 kg (0.40 lbs)

Heat insulation Class H: 180°C (356°F)

Ambient temperature range: -30/+60°C (-22/+140°F)

Inlet voltage fluctuations must not exceed ±10% of nominal voltage to obtain correct operation and long life coils.

X	Y	Connections	Circuit	Voltage
01	30	DIN 43650 - ISO 4400	Standard	DC-RAC
07	30	AMP JUNIOR	Standard	DC
0G	03	SINGLE LEAD	Standard	DC *
14	30	DIN 43650 - ISO 4400	Bidirectional Diode	DC
15	30	AMP JUNIOR	Bidirectional Diode	DC
0H	03	SINGLE LEAD	Bidirectional Diode	DC *

* Length 300mm (11.8 inches), Ext. diameter 6.3mm (0.25 inches), External and internal Sheath Silicone rubber.

Z	Voltage V	Resistance Ohm (±7%)	Power W	Current A		ΔT °C (°F)
	Nominal	Ta = 20-25°C (68-77°F)	Cold coil	Cold coil	Hot coil	
OB	12 DC	7.2	20	1.7	1.2	105-110 (221-230)
OG	14 DC	9.0	20	1.6	1.1	
OC	24 DC	28.2	20	0.9	0.6	
AC	26 DC	33.6	20	0.8	0.5	
OV	24 RAC	23.1	20	0.9	-	110-125 (230-257)
OW	110 RAC	478.3	20	0.2	-	
OZ	220 RAC	1919.9	20	0.1	-	

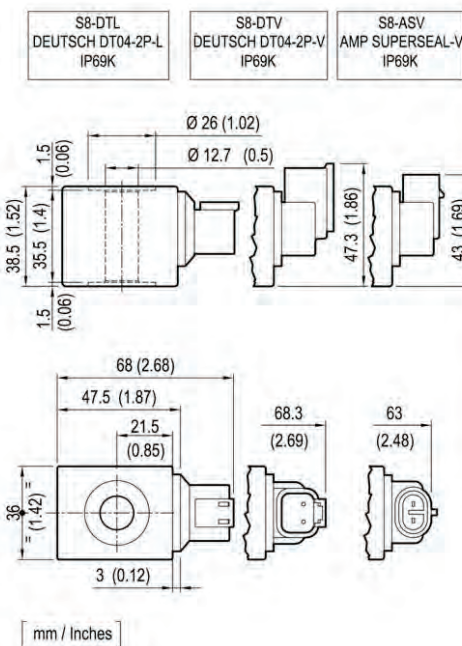

X	Y	Connections	Circuit	Voltage
20	30	DEUTSCH DT04-2P-L	Standard	DC
20	3P	DEUTSCH DT04-2P-V	Standard	DC
30	3P	AMP SUPERSEAL-V	Standard	DC
22	30	DEUTSCH DT04-2P-L	Bidirectional Diode	DC
22	3P	DEUTSCH DT04-2P-V	Bidirectional Diode	DC
32	3P	AMP SUPERSEAL-V	Bidirectional Diode	DC

Z	Voltage V	Resistance Ohm (±7%)	Power W	Current A		ΔT °C (°F)
	Nominal	Ta = 20-25°C (68-77°F)	Cold coil	Cold coil	Hot coil	
OB	12 DC	7.2	20	1.7	1.2	105-110 (221-230)
OC	24 DC	28.2	20	0.9	0.6	
AC	26 DC	33.6	20	0.8	0.5	

These coils have passed the THERMAL SHOCK DUNK TEST