

Part number:

**HYDROMA**

HYDRAULICKÉ SYSTÉMY

**HIDROMA  
SYSTEMS**

UKŁADY HYDRAULICZNE

**HYDROMA**

ГИДРАВЛИЧЕСКИЕ СИСТЕМЫ

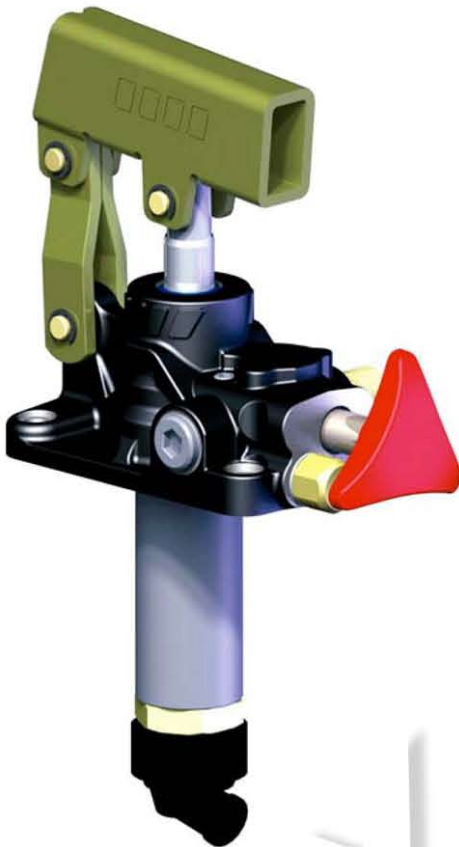
**"FULCRO"****CODICE FAMIGLIA**  
FAMILY CODE**106****POMPE A MANO  
CON VALVOLA DI SICUREZZA**  
HAND PUMPS WITH SAFETY VALVE**SERIE**  
SERIES**PMS+VS**  
**12-25-45**

Pompe a mano con azionamento a doppio effetto (la pompa eroga olio sia spingendo che tirando la leva) per impianti a semplice effetto, direttamente flangiabili su serbatoio e con rubinetto di scarico a tenuta conica incorporato. Sono disponibili in tre diverse cilindrate per consentire le più svariate applicazioni e per limitare lo sforzo sulla leva in ogni situazione. Hanno il corpo in ghisa sferoidale con trattamento in cataforesi anticorrosione e lo stelo nichelato.

Double acting hand pumps (the pump delivers oil both pushing and pulling the lever) suitable to operate single acting applications. They can be fitted also onto tank and are equipped with tapered lowering valve.

These hand pumps can have 3 different sizes to perform various applications and to achieve smoother loads on the lever. They are available with nodular cast-iron body with cathaphoresis anti-corrosion treatment and nickel-plated spool.

**Codice di ordinazione (senza leva)**  
Order code (without lever)

		<b>FULCRO 12</b>	<b>FULCRO 25</b>	<b>FULCRO 45</b>
<b>Senza Serbatoio</b> Without Tank		106-019-00013	106-010-00012	106-010-00021
	<b>Con serbatoi</b> With Tank Litri / Litres			
<b>Plastica / Plastic</b>	<b>1</b>	106-018-00014	106-008-00016	106-009-00060
	<b>2</b>	106-018-00023	106-008-00025	106-009-00051
	<b>3</b>	106-018-00032	106-008-00034	106-009-00015
	<b>5</b>	106-018-00041	106-008-00043	106-009-00024
	<b>7</b>	106-018-00050	106-008-00052	106-009-00033
	<b>10</b>	106-018-00069	106-008-00061	106-009-00042

**Ingombro**  
Overall Dimension

	<b>A</b>	<b>A1</b>	<b>B</b>	<b>D1</b>	<b>D2</b>	<b>E</b>
	mm	mm	mm	°	°	mm
<b>FULCRO 12</b>	143	187	120	18,5	45	35
<b>FULCRO 25</b>	142	193	127	20	45	35
<b>FULCRO 45</b>	141	193	138	20	45	42

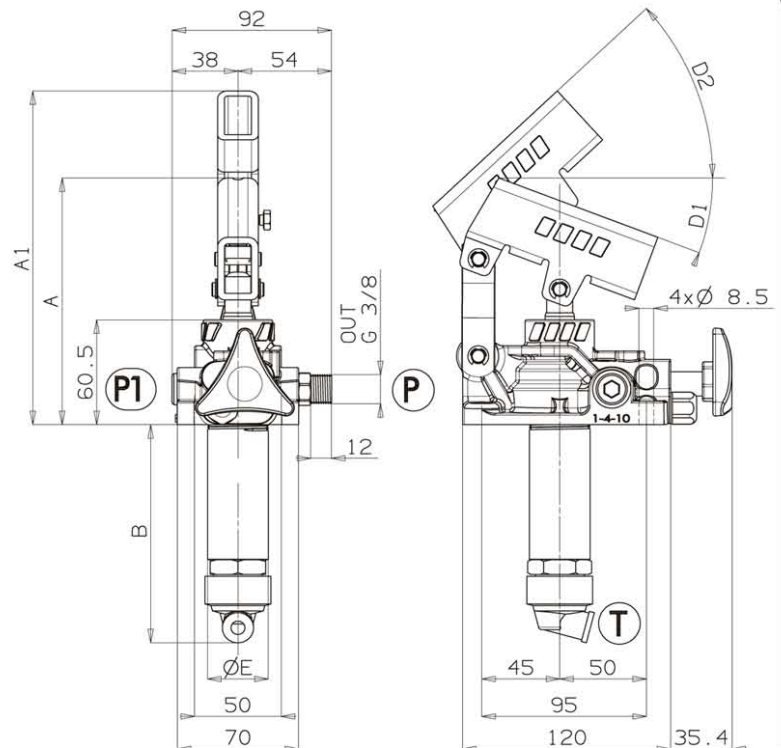
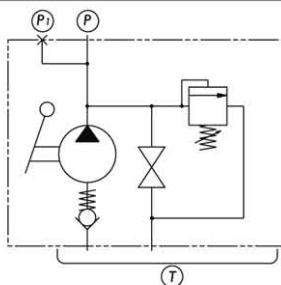
**Schema Idraulico**  
Hydraulic layout

SCHEMA RICAMBIO POMPE A MANO **FULCRO** SERIE PMS+VS  
**FULCRO** HAND PUMP PMS+VS SERIES SPARE PARTS

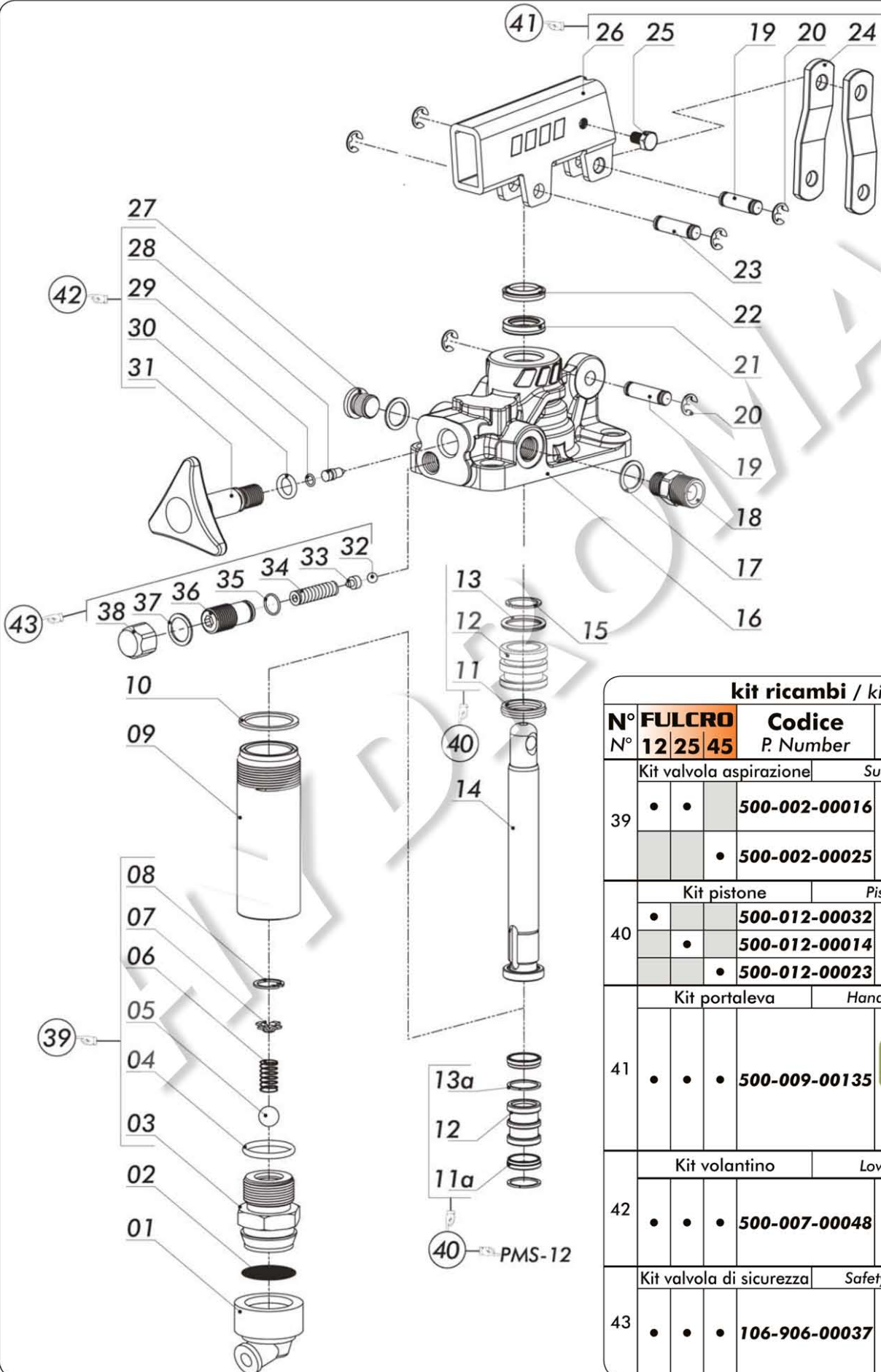

kit ricambi / kit's				
N°	FULCRO	Codice	Gruppo	
N°	12 25 45	P. Number	Assembly	
Kit valvola aspirazione		Suction valve kit		
39	•	•	500-002-00016	
		•	500-002-00025	
Kit pistone		Piston assembly		
40	•		500-012-00032	
		•	500-012-00014	
		•	500-012-00023	
Kit portaleva		Hand lever holder kit		
41	•	•	500-009-00135	
Kit volantino		Lowering valve kit		
42	•	•	500-007-00048	
Kit valvola di sicurezza		Safety valve assembly		
43	•	•	106-906-00037	

40 PMS-12



POMPE A MANO **FULCRO** SERIE PMS+VS  
**FULCRO** HAND PUMP PM+VS SERIES

**Dati Tecnici**  
*Technical data*

Tipo pompa <i>Pump type</i>	Taratura standard <i>Standard pressure setting</i>	Taratura massima <i>Max. pressure setting</i>	Cilindrata <i>Displacement</i>			Peso <i>Weight</i>
			Completa / Full <i>cm<sup>3</sup></i>	Tiro / Pull <i>cm<sup>3</sup></i>	Spinta / Push <i>cm<sup>3</sup></i>	
<b>FULCRO 12</b>	160 bar	300 bar	12	6,1	5,9	2,8 Kg
<b>FULCRO 25</b>	160	300	25	13,4	11,6	2,9
<b>FULCRO 45</b>	160	270	45	23,7	21,3	3,2

Fluido idraulico <i>Fluid</i>	Minerale o sintetico compatibile con guarnizioni: <i>Mineral or synthetic compatible with the following seals:</i> NBR, FKM, FPM, Nylon				
Viscosità cinematica consigliata <i>Kinematic viscosity suggested</i>	T media ambiente (°C) <i>Average ambient temp. (°C)</i>	< -10	-10÷10	10÷35	> 35
	VG (cSt = mm <sup>2</sup> /s)	22	32	46	68
Pres. di aspirazione <i>Inlet pressure</i>		-0,3 ÷ 2 bar			

**Kit di guarnizioni**  
*Seal kit*

<b>FULCRO 12</b>	<b>FULCRO 25</b>	<b>FULCRO 45</b>
106-900-00408	106-900-00453	106-900-00506



106-000-00032 PIA.APP.GRP.PMP. PMS-PMI  
MOUNTING PLATE FOR TANK PMS-PMI

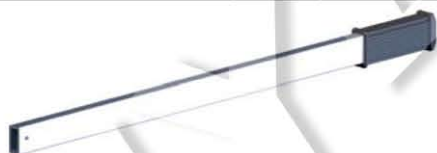

106-000-00078 AST. CON IMP.PMS/PMI L.600 MM 35x15  
LEVER FOR PMS/PMI L. 600 MM 35x15



106-000-00247 MAGGIORAZIONE RITORNO A MOLLA X PMS  
SPRING RETURN FOR PMS



106-960-00700 KIT MONTAGGIO POMPE PMS/PMI  
MOUNTING KIT FOR PUMPS PMS/PMI

**Sforzo in fase di pompaggio con leva standard**  
*Load while pumping with standard lever*

**FULCRO 12**

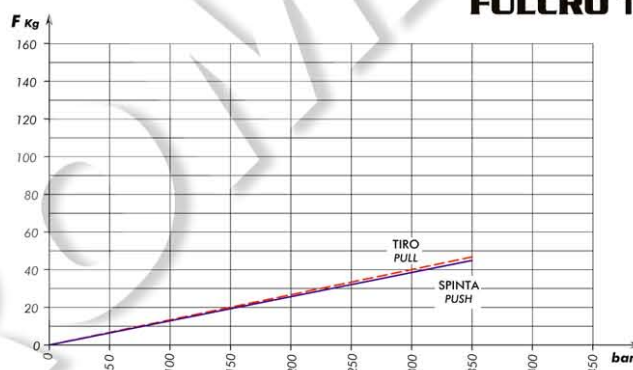

**FULCRO 25**

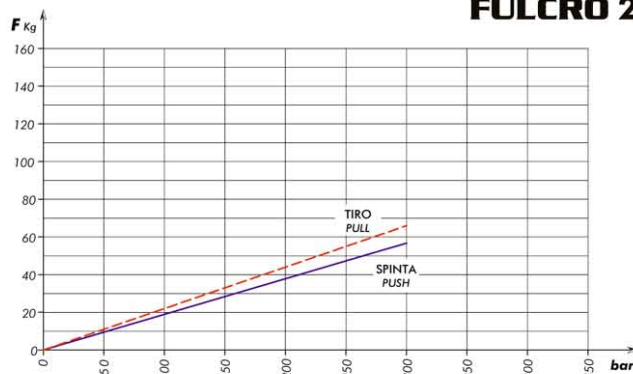

**FULCRO 45**

