

Part number:

060-10008

HYDROMA

HYDRAULICKÉ SYSTÉMY

**HIDROMA
SYSTEMS**

UKŁADY HYDRAULICZNE

HYDROMA

ГИДРАВЛИЧЕСКИЕ СИСТЕМЫ

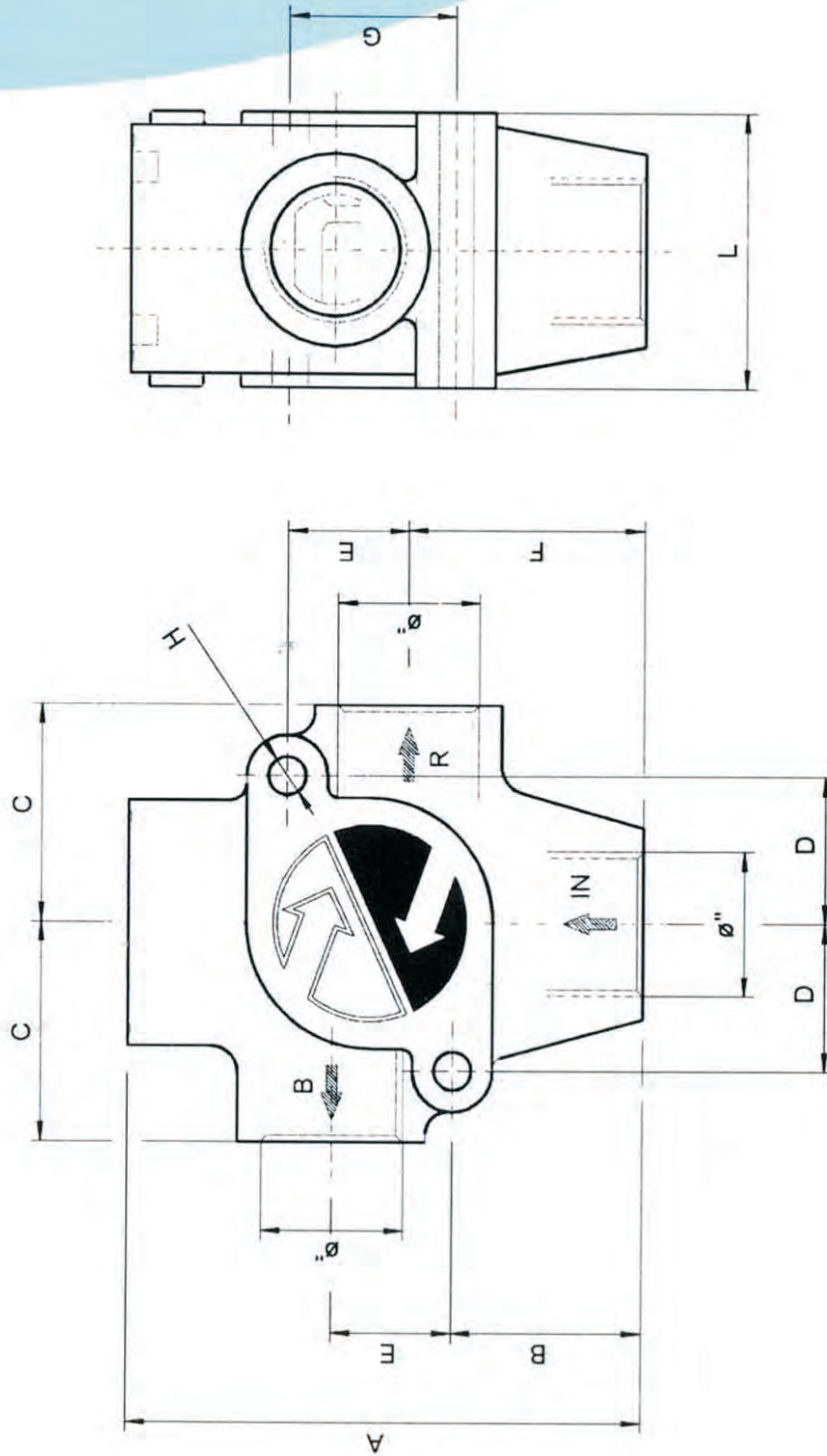
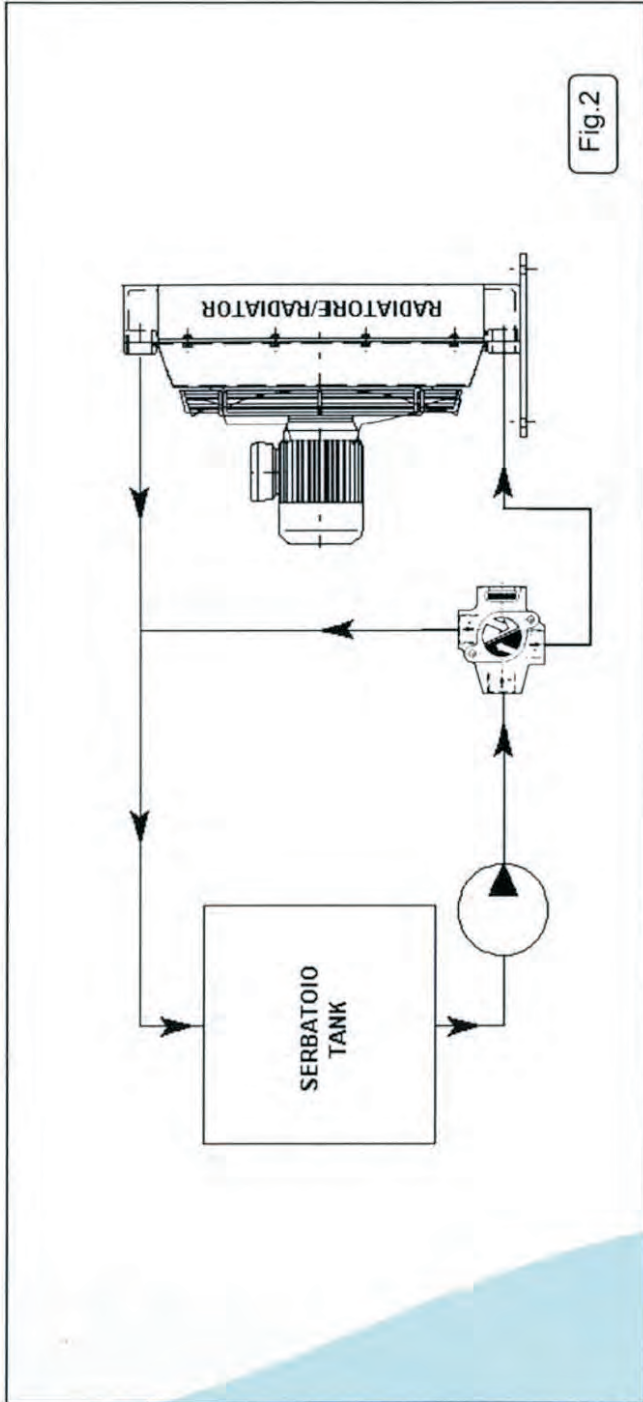

Fig.1

IN : INGRESSO / INLET R : SCAMBIATORE/ HEAT EXCHANGERS B : BY-PASS

Tipo Type	Ø BSP	A	B	C	D	E	F	G	H	L
012	1/2"	102	41	46,5	27	23	51	33	Ø 6,5	50
034	3/4"	102	41	46,5	27	23	51	33	Ø 6,5	50
100	1"	122	49	55,5	43,5	32,5	59,5	43	Ø 8,5	64
112	1 1/2"	122	49	55,5	43,5	32,5	59,5	43	Ø 8,5	64



PERDITE DI CARICO (ISO VG 46 @ 40°C)
PRESSURE DROP (ISO VG 46 @ 40°C)

