

Part number:

076-10162a**HYDROMA**

HYDRAULICKÉ SYSTÉMY

**HIDROMA
SYSTEMS**

UKŁADY HYDRAULICZNE

HYDROMA

ГИДРАВЛИЧЕСКИЕ СИСТЕМЫ

ALP3

COME ORDINARE / HOW TO ORDER

ALP3	TIPO TYPE	ROTAZIONE ROTATION	TAGLIA SIZE	ALBERO* SHAFT*	PORTE* PORTS*	GUARNIZIONI* SEALS*	OPZIONI* OPTIONS*	DRENAGGIO DRAIN
	omit	D DESTRA CLOCKWISE	30					
	A	S SINISTRA COUNTER CLOCKWISE	33					
		R** REVERSIBILE REVERSIBLE	40					
			50					
			60					
			66					
			80					
			94					
			110					
			120					
			135					

Guarnizioni / Seals

omit (T range = -10°C + 80°C)

V

...

Opzioni / Options

TR

...

Drenaggio (solo per rotazione R)

Drain (only for R rotation)

E0 = drenaggio interno/ internal drain

E1 = drenaggio esterno/ external drain G3/8

*** E2 = drenaggio esterno/ external drain 3/4-16 UNF

...

(*) = campi da specificare se diversi dallo standard "tipo pompa" / to be specified if different from standard pump type

(**) = la rotazione reversibile R è disponibile per tutte le taglie indicate / R rotation is available for all listed displacements.

(***) = La porta di drenaggio "E2" è lavorata secondo la specifica SAE J1926/1 (ISO 11926-1) relativa a porte filettate con tenuta O-ring. Profondità utile 12,7 mm. / "E2" drain port is machined in compliance with threaded port with O-ring seal in truncated housing SAE J1926/1 (ISO 11926-1). Thread depth 12,7 mm.

Tipi Pompa Standard / Pump Standard Types

omit = flangia europea + albero T0 + porte E + guarnizioni standard / european flange + shaft T0 + ports E + standard seals

A = flangia A + albero C1 + porte A + guarnizioni standard / flange A + shaft C1 + ports A + standard seals

Esempi / Examples:

ALP3-D-30 = pompa destra, 20 cc/rev, flangia europea, albero conico 1:8, porte flangiate tipo E, guarnizioni standard clockwise rotation, 20 cc/rev, european flange, 1:8 tapered shaft, flanged ports E type, standard seals

ALP3-D-30-C0 = pompa destra, 20 cc/rev, flangia europea, albero cilindrico (C0), porte flangiate tipo E, guarnizioni standard clockwise rotation, 20 cc/rev, european flange, cylindrical shaft (C0), flanged ports E type, standard seals

ALP3A-D-30-E = pompa destra, 20 cc/rev, flangia B-2 fori, albero cilindrico, porte flangiate (E), guarnizioni standard clockwise rotation, 20 cc/rev, B 2 bolt flange, cylindrical shaft, european flanged ports (E), standard seals

LE TAVOLE DI PRODOTTO RAPPRESENTANO I TIPI POMPA STANDARD PER MARZOCCHI POMPE. LE TAVOLE SINOTTICHE DI FLANGE, ALBERI E PORTE HANNO LO SCOPO DI RAPPRESENTARE TUTTE LE POSSIBILI CONFIGURAZIONI DI PRODOTTO. PER MAGGIORI DETTAGLI SULLE DISPONIBILITÀ E CONDIZIONI DI FORNITURA, CONSIGLIAMO DI INTERPELLARE IL NOSTRO UFFICIO TECNICO-COMMERCIALE.

THE PRODUCT DATA SHEETS SHOW OUR STANDARD MODEL TYPES. THE SYNOPTIC TABLES FOR FLANGES, SHAFTS AND PORTS SHOW ALL THE POSSIBLE CONFIGURATIONS. FOR FURTHER DETAILS ABOUT THE AVAILABILITY OF EACH CONFIGURATION PLEASE CONTACT OUR SALES AND TECHNICAL DEPT.

Part number:

076-10162b

HYDROMA

HYDRAULICKÉ SYSTÉMY

**HIDROMA
SYSTEMS**

UKŁADY HYDRAULICZNE

HYDROMA

ГИДРАВЛИЧЕСКИЕ СИСТЕМЫ

ALP3

Parti accessorie a corredo della pompa standard: linguetta a disco (codice 522058), dado M14x1.5 (codice 523017), rosetta elastica spaccata (codice 523006).
Porte standard: filetti M10 profondità utile 19 mm.

Accessories supplied with the standard pump: woodruff key (code 522058), M14x1.5 exagonal nut (code 523017), washer (code 523006).
Standard ports: M10 threads depth 19 mm.

MANDATA
OUTLET

ASPIRAZIONE
INLET

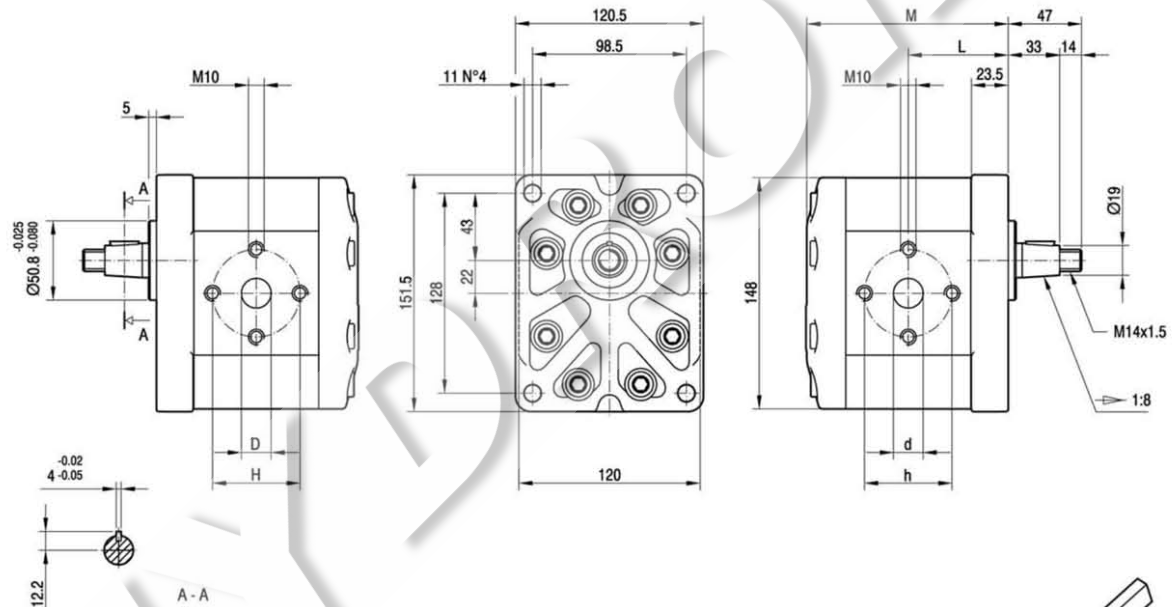

TIPO TYPE	CILINDRATA DISPLACEMENT	PORTATA a 1500 giri/min FLOW at 1500 rev/min	PRESSIONI MASSIME MAX PRESSURE			VELOCITÀ MASSIMA MAX SPEED	DIMENSIONI DIMENSIONS					
			P ₁	P ₂	P ₃		L	M	d	D	h	H
	cm ³ /giro [cm ³ /rev]	litri/min [litres/min]	bar	bar	bar	giri/min [rpm]	mm	mm	mm	mm	mm	mm
ALP3-D-30	20	29	230	250	270	3500	64	129,5	27	19	56	56
ALP3-D-33	22	31	230	250	270	3500	64,5	130,5	27	19	56	56
ALP3-D-40	26	37	230	250	270	3000	66	133,5	27	19	56	56
ALP3-D-50	33	48	230	250	270	3000	68,5	138,5	27	19	56	56
ALP3-D-60	39	56	220	240	260	3000	70,5	142,5	27	19	56	56
ALP3-D-66	44	62	210	230	250	2800	72	145,5	27	27	51	51
ALP3-D-80	52	74	200	215	230	2400	75	151,5	27	27	56	56
ALP3-D-94	61	87	190	205	220	2800	78	157,5	33	27	62	51
ALP3-D-110	71	101	170	185	200	2500	81,5	164,5	33	27	62	51
ALP3-D-120	78	112	160	175	190	2300	84	169,5	33	27	62	51
ALP3-D-135	87	124	140	155	170	2000	87	175,5	33	27	62	51

Part number:

076-10162c

HYDROMA

HYDRAULICKÉ SYSTÉMY

**HIDROMA
SYSTEMS**

UKŁADY HYDRAULICZNE

HYDROMA

ГИДРАВЛИЧЕСКИЕ СИСТЕМЫ

ALP3

FLANGE / FLANGES

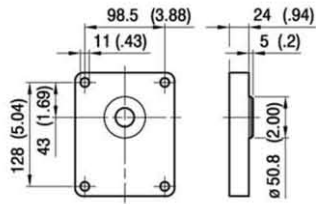

A

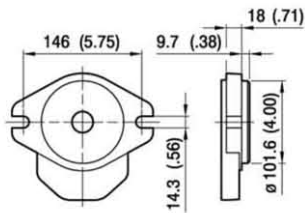

A

ALBERI / SHAFTS

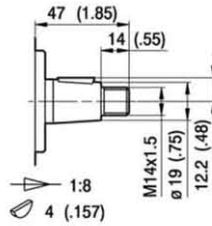

T0

Coppia Max
Max Torque 300 Nm

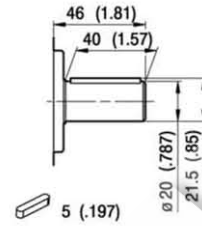

C0

Coppia Max
Max Torque 350 Nm

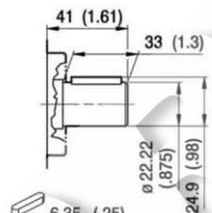

C1

Coppia Max
Max Torque 450 Nm

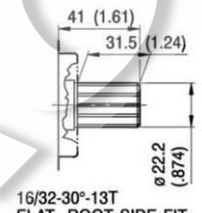

S1

Coppia Max
Max Torque 600 Nm

Part number:

076-10162d**HYDROMA**

HYDRAULICKÉ SYSTÉMY

**HIDROMA
SYSTEMS**

UKŁADY HYDRAULICZNE

HYDROMA

ГИДРАВЛИЧЕСКИЕ СИСТЕМЫ

ALP3

PORTE / PORTS

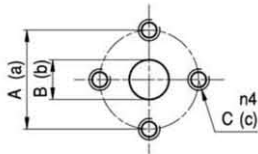
**E**

TIPO TYPE	ASPIRAZIONE INLET			MANDATA OUTLET		
	A	B	C	a	b	c
ALP3...30 ÷ ALP3...60	56	27	M10	56	19	M10
ALP3...66	51	27	M10	51	27	M10
ALP3...80	56	27	M10	56	27	M10
ALP3...94 ÷ ALP3...135	62	33	M10	51	27	M10

I valori delle coppie di serraggio delle viti presenti nel kit raccordo sono indicate a pag 57 (capitolo accessori).
Tightening torques of the fittings screws are specified on page 57 (accessories section).

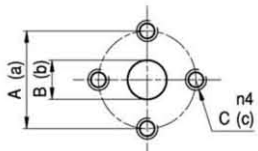
**EP**

TIPO TYPE	ASPIRAZIONE INLET			MANDATA OUTLET		
	A	B	C	a	b	c
ALP3...30 ÷ ALP3...33	40	19	M8	40	19	M8
ALP3...40 ÷ ALP3...80	51	27	M10	40	19	M8

I valori delle coppie di serraggio delle viti presenti nel kit raccordo sono indicate a pag 57 (capitolo accessori).
Tightening torques of the fittings screws are specified on page 57 (accessories section).

**FG**

TIPO TYPE	ASPIRAZIONE INLET	MANDATA OUTLET
	A	a
ALP3...30 ÷ ALP3...33	G3/4	G3/4
ALP3...40 ÷ ALP3...60	G1	G3/4
ALP3...66 ÷ ALP3...94	G1 1/4	G1
ALP3...110 ÷ ALP3...135	G1 1/2	G1 1/4

Raccordo G3/4 coppia di serraggio massima 60 Nm. Raccordo G1 coppia di serraggio massima 70 Nm. Raccordo G1 1/4 coppia di serraggio massima 80 Nm. Raccordo G1 1/2 coppia di serraggio massima 90 Nm. Consigliamo di richiedere conferma al fornitore del raccordo.

Tightening torques for G3/4 fitting: 60 Nm. Tightening torques for G1 fitting: 70 Nm. Tightening torques for G1 1/4 fitting: 80 Nm. Tightening torques for G1 1/2 fitting: 90 Nm. Please check with the fittings suppliers.

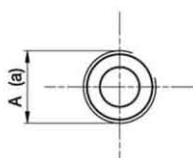
**FC**

TIPO TYPE	ASPIRAZIONE INLET	MANDATA OUTLET
	A	a
ALP3...30 ÷ ALP3...33	Rc3/4	Rc3/4
ALP3...40 ÷ ALP3...60	Rc1	Rc3/4
ALP3...66 ÷ ALP3...94	Rc1 1/4	Rc1
ALP3...110 ÷ ALP3...135	Rc1 1/2	Rc1 1/4

Raccordo Rc3/4 coppia di serraggio massima 60 Nm. Raccordo Rc1 coppia di serraggio massima 70 Nm. Raccordo Rc1 1/4 coppia di serraggio massima 80 Nm. Raccordo Rc1 1/2 coppia di serraggio massima 90 Nm. Consigliamo di richiedere conferma al fornitore del raccordo.

Tightening torques for Rc3/4 fitting: 60 Nm. Tightening torques for Rc1 fitting: 70 Nm. Tightening torques for Rc1 1/4 fitting: 80 Nm. Tightening torques for Rc1 1/2 fitting: 90 Nm. Please check with the fittings suppliers.

Part number:

076-10162e

HYDROMA

HYDRAULICKÉ SYSTÉMY

**HIDROMA
SYSTEMS**

UKŁADY HYDRAULICZNE

HYDROMA

ГИДРАВЛИЧЕСКИЕ СИСТЕМЫ

Potenza assorbita Absorbed power P [kW]
Momento torcente assorbito Absorbed torque M [Nm]
Velocità di rotazione Drive speed n [giri/min] [rpm]

