

Part number:

HYDROMA

HYDRAULICKÉ SYSTÉMY

**HIDROMA
SYSTEMS**

UKŁADY HYDRAULICZNE

HYDROMA

ГИДРАВЛИЧЕСКИЕ СИСТЕМЫ

6/2 ways/positions flow diverters, 6 to 10/2 ways/positions flow diverters

RE 18302-04/12.09

L710... (VS120-VS125-VS129)

Size 4
Series 00
Maximum operating pressure 310 bar [4500 psi]
Maximum flow 25 l/min [6.6 gpm]
Ports G 1/4 - SAE4 - JIS B 1/4



DVI0083

Summary

Description	
General specifications	
Ordering details	
Spool variants	
Principles of operation, cross section	
Technical data	
$\Delta p-Q_v$ characteristic curves	
External dimensions and fittings	
Electric connection	

General specifications

Page	- 6 way 2 position valve.
1	- Directional spool valve with direct solenoid control.
2	- Upon request, hydraulic / pneumatic pilot.
2	- Control spool operated by screwed-in solenoid, with easily extractable coil fastened by a ring nut.
3	- Wet pin tube for DC coil, with push rod for mechanical override in case of voltage shortage.
3	- Unrestricted 360° orientation of DC coil.
5	- Control spool held in normal position by return spring.
6	- Optional manual override (push-button or screw type).
9	- Connectors available: DIN 43650 – ISO 4400, AMP Junior, DT04-2P (Deutsch), Free leads.

Ordering details

L		7	10	-	-	-	-	-	-	0																																																																																
Family Compact directional valve																																																																																										
Type Flow Diverters																																																																																										
Ports G 1/4 DIN3852 = 2 9/16-18 UNF2-B (SAE6) = A JIS B G 1/4 = J																																																																																										
Control type Solenoid (coil C36) without emergency = 10 Solenoid (coil C36) with push-button type emergency = 1P Solenoid (coil C36) with screw type emergency = 1F Hydraulic / pneumatic control = P1																																																																																										
Spool Variants 6 way / 2 position P1 side = 6_ 6 way / 2 position P2 side = 7_																																																																																										
Drain type Internal drain = I External drain = E																																																																																										
									Electric connections 00 = Without coil 01 = With coil, without connector 02 = With coil and with non-assembled connector, type DIN 43650 – ISO 4400 03 = With coil having AMP Junior connector 04 = With coil having AMP Junior Horiz. connector 07 = With coil having DEUTSCH DT 04-2P connect. 31 = With coil and bipolar sheathed lead 350mm [13.8"] long																																																																																	
									Voltage supply Without coil 12V DC 13V DC 24V DC 27V DC 48V DC 110V DC																																																																																	
		<table border="1"> <tr> <td>00 =</td> <td></td> <td></td> <td></td> <td></td> <td></td> <td></td> <td></td> <td></td> <td></td> </tr> <tr> <td>OB =</td> <td></td> <td></td> <td></td> <td></td> <td></td> <td></td> <td></td> <td></td> <td></td> </tr> <tr> <td>AD =</td> <td></td> <td></td> <td></td> <td></td> <td></td> <td></td> <td></td> <td></td> <td></td> </tr> <tr> <td>OC =</td> <td></td> <td></td> <td></td> <td></td> <td></td> <td></td> <td></td> <td></td> <td></td> </tr> <tr> <td>AC =</td> <td></td> <td></td> <td></td> <td></td> <td></td> <td></td> <td></td> <td></td> <td></td> </tr> <tr> <td>OD =</td> <td></td> <td></td> <td></td> <td></td> <td></td> <td></td> <td></td> <td></td> <td></td> </tr> <tr> <td>OE =</td> <td></td> <td></td> <td></td> <td></td> <td></td> <td></td> <td></td> <td></td> <td></td> </tr> <tr> <td></td> <td>31</td> <td>07</td> <td>04</td> <td>03</td> <td>02</td> <td>01</td> <td>00</td> <td></td> <td></td> </tr> </table>							00 =										OB =										AD =										OC =										AC =										OD =										OE =											31	07	04	03	02	01	00				
00 =																																																																																										
OB =																																																																																										
AD =																																																																																										
OC =																																																																																										
AC =																																																																																										
OD =																																																																																										
OE =																																																																																										
	31	07	04	03	02	01	00																																																																																			
		Available connections																																																																																								

Spool variants

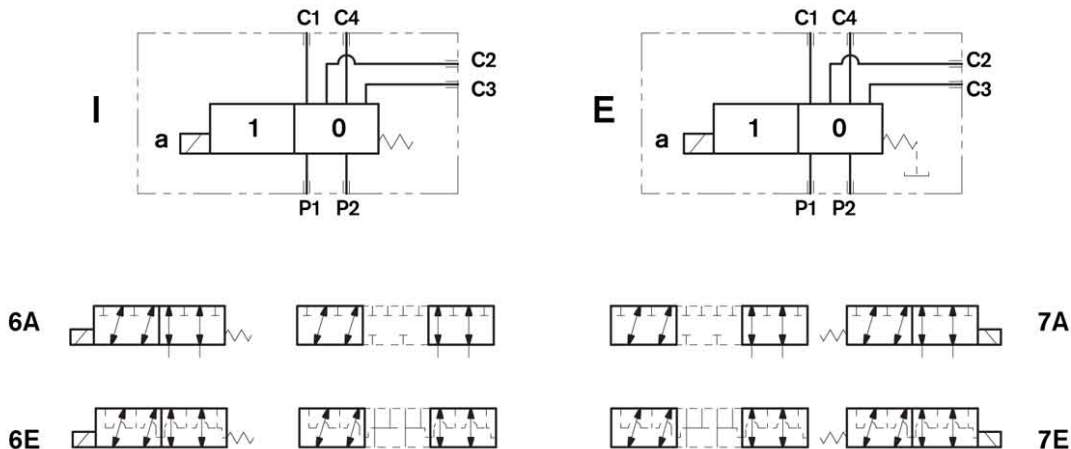

Principles of operation, cross section

A valve basically consists of a housing (1), a control spool (2), a return spring (3) and a solenoid (4). It is designed to connect two inlet lines P1 – P2 (normally a set of hoses) and divert them to either the outlet ports (C1 – C4) with spool in position "0", when the solenoid is de-energized, or to the outlet ports (C2 – C3) with spool in position "1", when the solenoid is energized.

With the coil de-energized, the return spring (3) pushes back the spool (2) and holds it in position "0"

The coil (4) is fastened to the tube by the ring nut (6).

The manual override (6) allows to shift the spool (2) also in case of voltage shortage.

Hydraulic / pneumatic pilot control for spool shifting is available upon request.

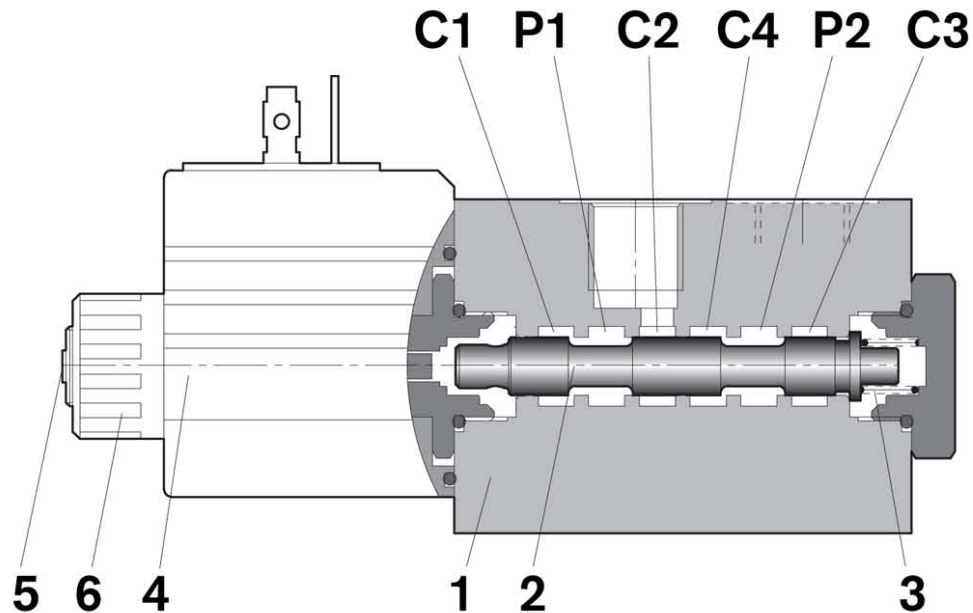

Technical Data (for applications with different specifications consult us)

General

Valve weight	kg [lbs]	1.13 [2.5]
Mounting position		unrestricted
Ambient Temperature	°C [°F]	-20....+50 [-4....+122] (NBR seals)

Hydraulic

Maximum pressure with external drain	bar [psi]	310 [4500]
Maximum pressure with internal drain	bar [psi]	250 [3625]
Maximum inlet flow	l/min [gpm]	25 [6.6]
Hydraulic fluid		Mineral oil based hydraulic fluids HL (DIN 51524 part 1). Mineral oil based hydraulic fluids HLP (DIN 51524 part 2). For use of environmentally acceptable fluids (vegetable or polyglycol base) please consult us.
Fluid Temperature	°C [°F]	-20....+80 [-4....+176] (NBR seals)
Permissible degree of fluid contamination		ISO 4572: $\beta_x \geq 75$ X=12...15 ISO 4406: class 20/18/15 NAS 1638: class 9
Viscosity range	mm ² /s	5....420
Internal leakage with 100 bar [1450 psi] secondary pressure at C	cc/min [in ³ /min]	min.7 [0.43] max. 15 [0.74]

Electrical

Voltage type	DC										
Voltage tolerance (nominal voltage)	%	-10 +10									
Duty	Continuous, with ambient temperature $\leq 50^{\circ}\text{C}$ [122°F]										
Maximum coil temperature	$^{\circ}\text{C}$ [°F]	150 [302]									
Insulation class	H										
Compliance with	Low Voltage Directive LVD 73/23/EC (2006/95/EC), 2004/108/EC										
Coil weight with connection EN 175301-803	kg [lbs]	0.215 [0.44]									
Voltage	V	12	13	24	27	48	110				
Voltage type		DC	DC	DC	DC	DC	DC				
Power consumption	W	26	26	26	26	26	26				
Current ⁽¹⁾	A	2.15	2.00	1.10	1.00	0.54	0.27				
Resistance ⁽²⁾	Ω	5.5	6.5	22	28	89	413				

1) Nominal - 2) $\pm 7\%$ at temperature 20°C [68°F]

	Voltage (V)	Connector type	Coil description	Marking	Coil Mat no.
=OB 01 =OB 02	12 DC	EN 175301-803 (Ex. DIN 43650)	C3601 12DC	12 DC	R933000044
=OB 03	12 DC	AMP JUNIOR	C3603 12DC	12 DC	R933000047
=OB 04	12 DC	AMP JUNIOR Horizontal	C3604 12DC	12 DC	R933002913
=OB 07	12 DC	DEUTSCH DT 04-2P	C3607 12DC	12 DC	R933000048
=OB 31	12 DC	Cable 350 mm long	C3631 12DC	12 DC	R933000045
=AD 01 =AD 02	13 DC	EN 175301-803 (Ex. DIN 43650)	C3601 13DC	13 DC	R933000051
=AD 07	13 DC	DEUTSCH DT 04-2P	C3607 13DC	13 DC	R933000049
=OC 01 =OC 02	24 DC	EN 175301-803 (Ex. DIN 43650)	C3601 24DC	24 DC	R933000053
=OC 03	24 DC	AMP JUNIOR	C3603 24DC	24 DC	R933000057
=OC 04	24 DC	AMP JUNIOR Horizontal	C3604 24DC	24 DC	R933002914
=OC 07	24 DC	DEUTSCH DT 04-2P	C3607 24DC	24 DC	R933000058
=OC 31	24 DC	Cable 350 mm long	C3637 24DC	24 DC	R933000055
=AC 01 =AC 02	27 DC	EN 175301-803 (Ex. DIN 43650)	C3601 27DC	27 DC	R933000056
=AC 07	27 DC	DEUTSCH DT 04-2P	C3607 27DC	27 DC	R933000050
=OD 01 =OD 02	48 DC	EN 175301-803 (Ex. DIN 43650)	C3601 48DC	48 DC	R933000059
=OD 04	48 DC	AMP JUNIOR Horizontal	C3604 48DC	48 DC	R933002915
=OE 01 =OE 02	110 DC	EN 175301-803 (Ex. DIN 43650)	C3601 110DC	110 DC	R933000061

Characteristic curves

Measured with hydraulic fluid ISO-VG32 at $45^{\circ} \pm 5^{\circ} \text{ C}$ [$113^{\circ} \pm 9^{\circ} \text{ F}$]; ambient temperature 20° C [68° F].

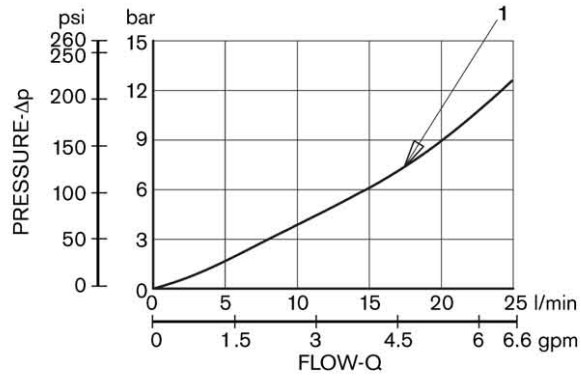

Flow path	Curve No.
P1>C1	1
P1>C2	1
P2>C3	1
P2>C4	1

DI-DE performance limits

The performance limits refer to the following conditions: coils at operating temperature, voltage supply 10% below nominal, no back pressure in the tank line.

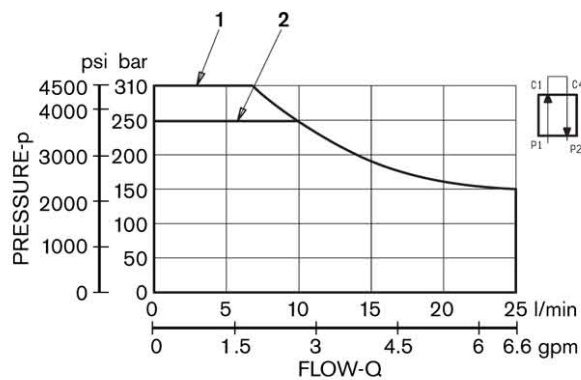

Drain type	Curve No.
External (-E-)	1
Internal (-I-)	2

Flow across both ways: forward across P1>C1 and reverse across C4>P2

External Dimensions and Fittings

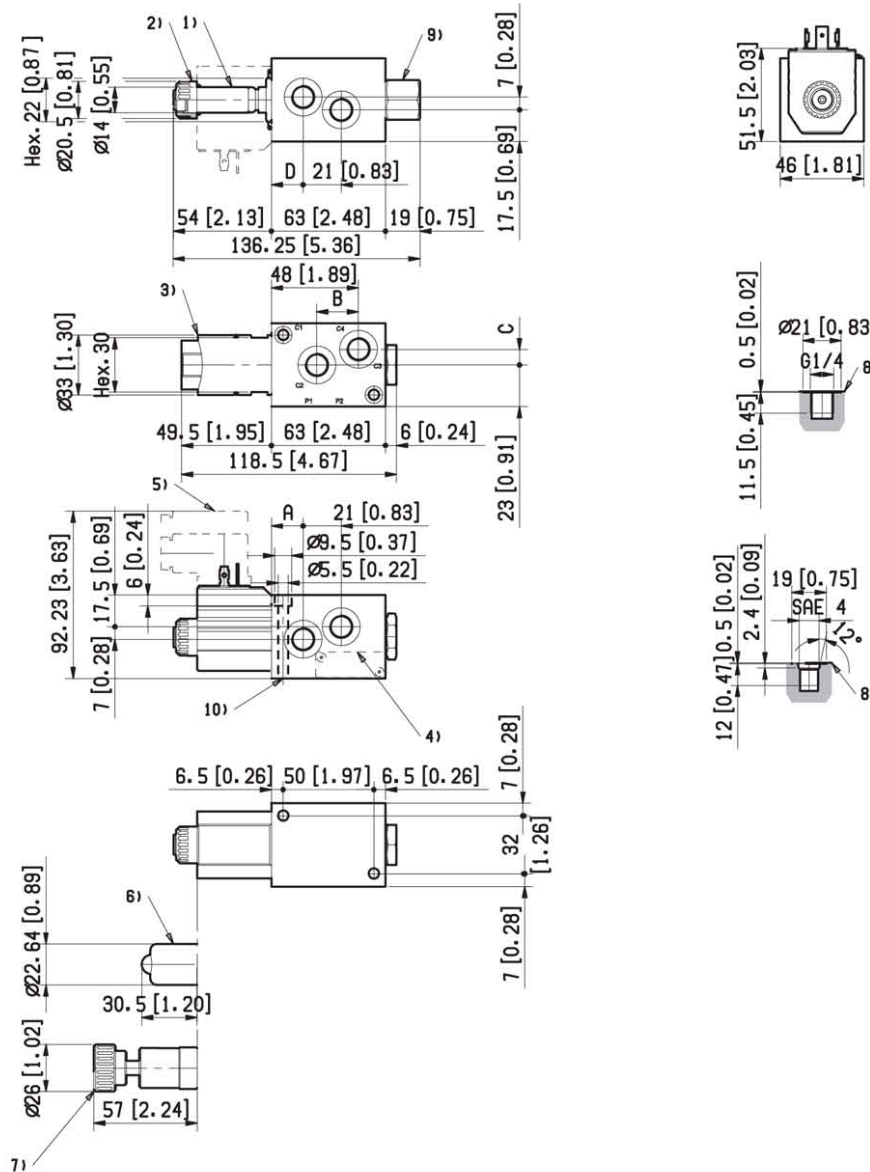

Measure	VS120 (G1/4)	VS125 (SAE 4)
A mm [inch]	17.5 [0.69]	16.5 [0.65]
B mm [inch]	23 [0.91]	22.5 [0.89]
C mm [inch]	8.5 [0.33]	7.5 [0.30]
D mm [inch]	17.5 [0.69]	18.5 [0.73]

- Solenoid tube hex 22 mm.
Torque 20-22Nm [14.6-16.2 ft-lb].
- Ring nut for coil locking OD 20.5 mm [1.04 in].
Torque 3-4 Nm [2.2-3.0 ft-lb].
- Optional hydraulic / pneumatic piloted version.
Pilot port plug available with G 1/4; hex 30 mm.
Torque 20 – 22 Nm [14.7 – 16.2 ft-lb].
- Identification label.
- Minimum clearance needed for connector removal.
- Optional push-button, EP type, emergency for spool opening: it is pressure stuck to the ring nut for coil locking.
Mat no. R933000042.
- Optional screw, EF type, emergency for spool opening: it is screwed (torque 6-7 Nm [4.4-5.5 ft-lb]) to the tube as replacement of the coil ring nut. Mat no. R933000021 .
- Ports P1, P2, C1, C2, C3, C4.
- External drain plug available with G 1/4 and SAE 4 port.
Hex 22mm, torque 20-22 Nm [14.7-16.2 ft-lb].
- Two fixation holes Use M5 screws with strength class DIN 8.8. Torque 5-6 Nm [3.6-4.4 ft-lb].

External Dimensions and Fittings

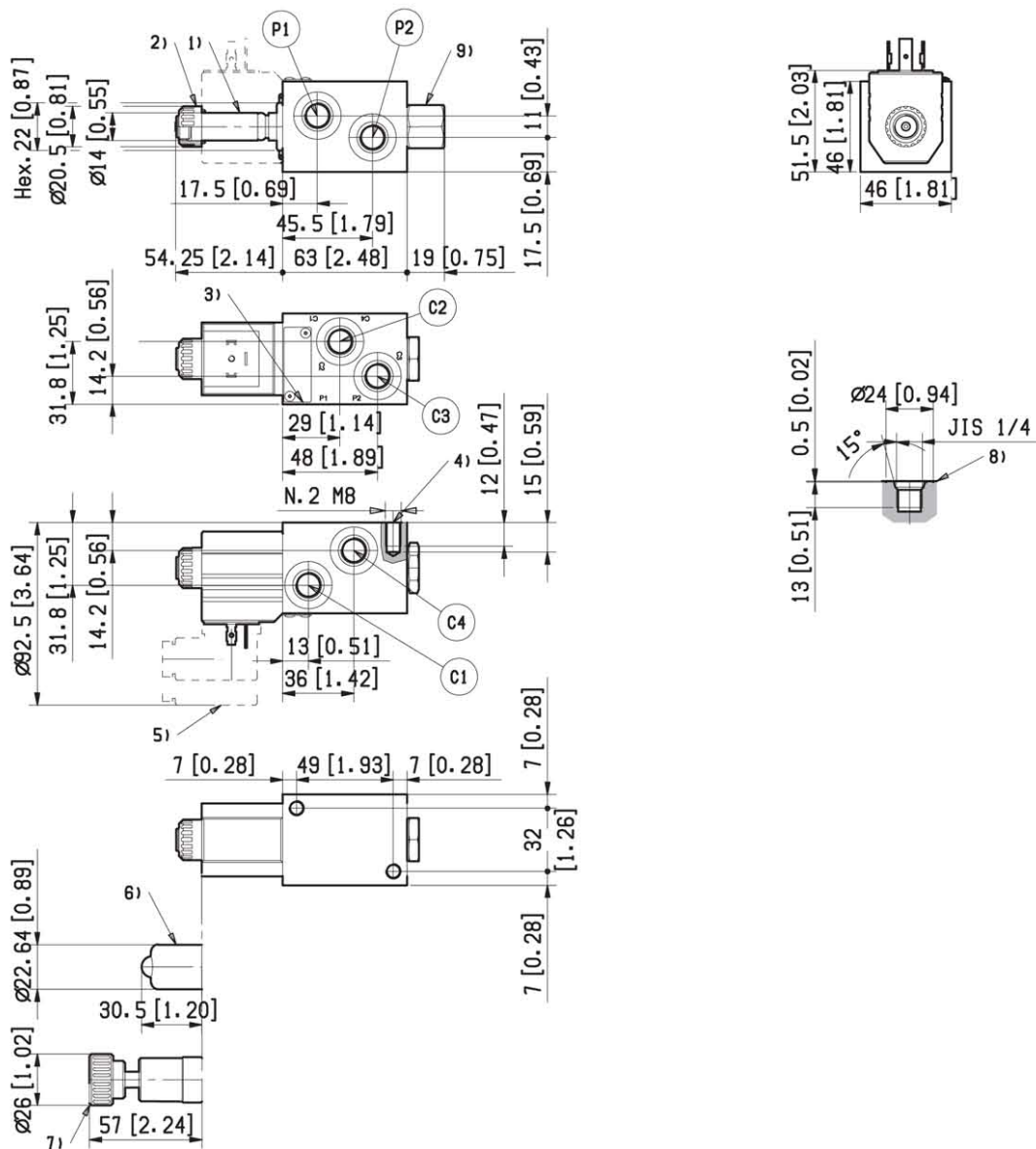

1 Solenoid tube hex 22 mm.

Torque 20-22Nm [14.6-16.2 ft-lb].

2 Ring nut for coil locking OD 20.5 mm [1.04 in].

Torque 3-4 Nm [2.2-3.0 ft-lb].

3 Identification label.

4 Two fixation holes M8.

5 Minimum clearance needed for connector removal.

6 Optional push-button, EP type, emergency for spool opening: it is pressure stuck to the ring nut for coil locking. Mat no. R933000042

7 Optional screw, EF type, emergency for spool opening: it is screwed (torque 6-7 Nm [4.4-5.5 ft-lb]) to the tube as replacement of the coil ring nut. Mat no. R933000021.

8 Ports P1, P2, C1, C2, C3, C4.

Electric connection

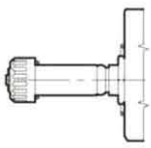
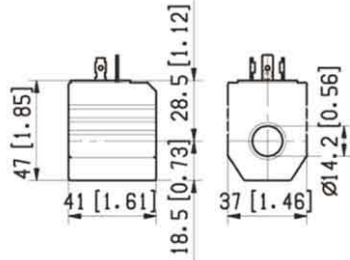
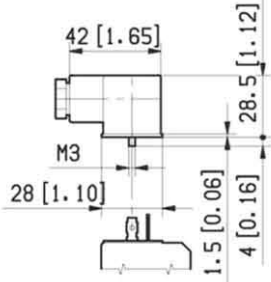
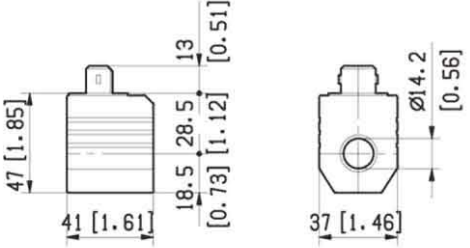
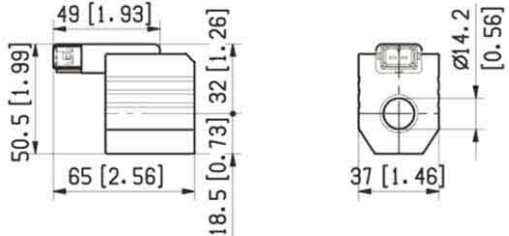
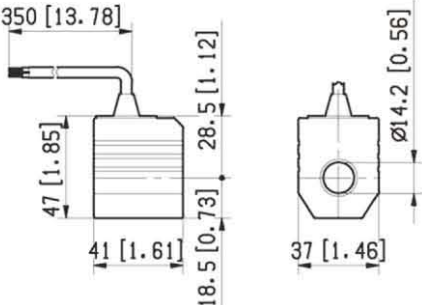
<p>=00</p> <p>Without coils, but with ring nut and O-Rings for coil fitting (solution recommended for flexible stock handling)</p> 	<p>=01</p> <p>With coils having plug-in pins EN 175301-803, without connectors</p> 																		
<p>With coils and with connectors non-assembled, type EN 175301-803.</p> <p>Protection class: IP 65 when connector with seal is properly screwed down, and cable clamp is correctly tightened.</p> <p>182-09: Standard. 182-LED-T-A1: with LED monitoring presence of voltage. 182-09-G-DO-2-1: with VDR (Voltage Dependent Resistor), to prevent input voltage over-shootings.</p> <p>=02</p> <table border="1" data-bbox="159 840 702 1108"> <thead> <tr> <th>Mat. No.</th> <th>Description</th> </tr> </thead> <tbody> <tr> <td>R933002885</td> <td>182-09 GRAY</td> </tr> <tr> <td>R933002889</td> <td>182-09 BLACK</td> </tr> <tr> <td>R933002893</td> <td>182-LED-T-A1 12 DC</td> </tr> <tr> <td>R933002894</td> <td>182-LED-T-A1 24 DC</td> </tr> <tr> <td>R933002896</td> <td>182-LED-T-A1 48 DC</td> </tr> <tr> <td>R933002897</td> <td>182-LED-T-A1 110 DC</td> </tr> <tr> <td>R933002886</td> <td>182-09-G-DO-2-1 12DC with VDR</td> </tr> <tr> <td>R933002887</td> <td>182-09-G-DO-2-1 24DC with VDR</td> </tr> </tbody> </table> 		Mat. No.	Description	R933002885	182-09 GRAY	R933002889	182-09 BLACK	R933002893	182-LED-T-A1 12 DC	R933002894	182-LED-T-A1 24 DC	R933002896	182-LED-T-A1 48 DC	R933002897	182-LED-T-A1 110 DC	R933002886	182-09-G-DO-2-1 12DC with VDR	R933002887	182-09-G-DO-2-1 24DC with VDR
Mat. No.	Description																		
R933002885	182-09 GRAY																		
R933002889	182-09 BLACK																		
R933002893	182-LED-T-A1 12 DC																		
R933002894	182-LED-T-A1 24 DC																		
R933002896	182-LED-T-A1 48 DC																		
R933002897	182-LED-T-A1 110 DC																		
R933002886	182-09-G-DO-2-1 12DC with VDR																		
R933002887	182-09-G-DO-2-1 24DC with VDR																		
<p>=03</p> <p>With coils having AMP Junior connector, and with bi-directional diode.</p> <p>Protection class: IP 65 with female connector properly fitted (see drawing).</p> 	<p>=04</p> <p>With coils having Horizontal AMP Junior connector, and with bi-directional diode.</p> <p>Protection class: IP 65 with female connector properly fitted (see drawing).</p> 																		
<p>=31</p> <p>With coils having bi-directional diode and bipolar sheathed free lead, 350 mm long, without pins.</p> 	<p>=07</p> <p>With coils having DEUTSCH DT 04-2P connector, and with bi-directional diode.</p> <p>Protection class: IP 69 K with female connector properly fitted (see drawing).</p> 