

Part number:

006-10507

HYDROMA

HYDRAULICKÉ SYSTÉMY

**HIDROMA
SYSTEMS**

UKŁADY HYDRAULICZNE

HYDROMA

ГИДРАВЛИЧЕСКИЕ СИСТЕМЫ

**SEQUENZA, OTTURATORE DIFFERENZIALE
DIFFERENTIAL PISTON SEQUENCE**

VSQD-CC

05.22.03 - X - Y - Z

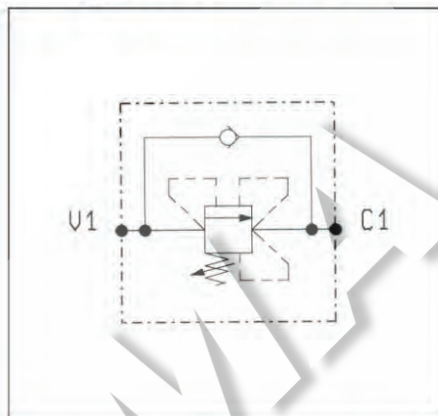
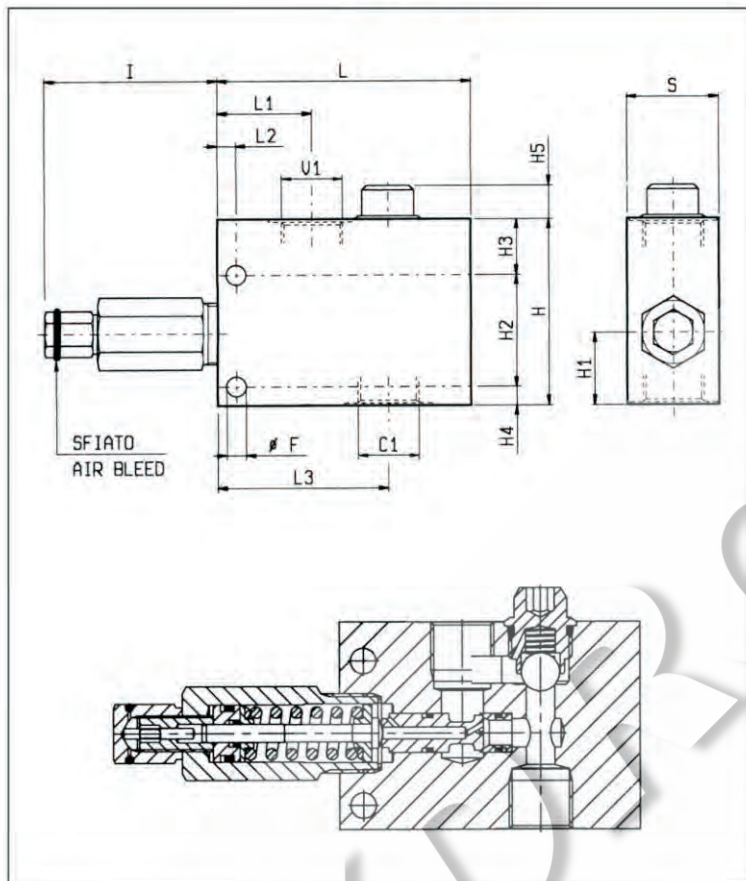

DATI TECNICI / TECHNICAL DATA

Pressione di lavoro max. 350 bar
Max. working pressure

Portata max. 80 l/min
Flow max.

Funzionamento corretto con pressione sul circuito secondario non inferiore a 20 bar.
For good performance, the pressure in the secondary circuit should not drop below 20 bar.

40	74	8	41	110	75	13	8	24	48	31	80	8.5			3/4	1.39
35	67	8	41	100	75	10	8	13	48	32	69	8.5			1/2	1.11
S	L3	L2	L1	L	I	H5	H4	H3	H2	H1	H	F			Y	Peso kg Weight kg

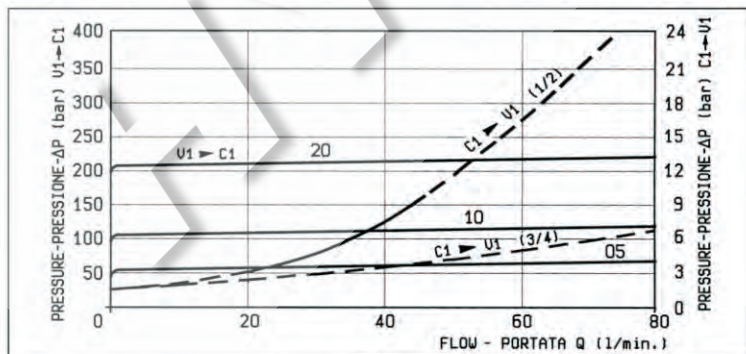

X	REGOLAZIONI ADJUSTMENTS
03	vite interna esagono incassato leakproof inner hex. socket screw

Z	MOLLE / SPRINGS				
	Campo taratura min - max bar Adj. press. range bar	Incremento press. bar / giro vite Press. increase bar / turn	Taratura standard bar (Q = 5 l/min) Std. setting bar (Q = 5 l/min)	Cod. ordinazione Ordering code	Colore Colour
05	15-50	15.5	50	03.51.01.150	nero black
10	40-100	33	100	03.51.01.151	blu blue
20	70-210	68	200	03.51.01.152	verde green

Y	ATTACCHI / PORT SIZE	
	V1-C1	
03	G 1/2	
04	G 3/4	